



EUROPEAN COMMISSION

Integrated Pollution Prevention and Control

Reference Document on
Best Available Techniques in the

Food, Drink and Milk Industries

August 2006

This document is one of a series of foreseen documents as below (at the time of writing, not all documents have been drafted):

Reference Document on Best Available Techniques . . .	Code
Large Combustion Plants	LCP
Mineral Oil and Gas Refineries	REF
Production of Iron and Steel	I&S
Ferrous Metals Processing Industry	FMP
Non Ferrous Metals Industries	NFM
Smitheries and Foundries Industry	SF
Surface Treatment of Metals and Plastics	STM
Cement and Lime Manufacturing Industries	CL
Glass Manufacturing Industry	GLS
Ceramic Manufacturing Industry	CER
Large Volume Organic Chemical Industry	LVOC
Manufacture of Organic Fine Chemicals	OFC
Production of Polymers	POL
Chlor – Alkali Manufacturing Industry	CAK
Large Volume Inorganic Chemicals - Ammonia, Acids and Fertilisers Industries	LVIC-AAF
Large Volume Inorganic Chemicals - Solid and Others industry	LVIC-S
Production of Speciality Inorganic Chemicals	SIC
Common Waste Water and Waste Gas Treatment/Management Systems in the Chemical Sector	CWW
Waste Treatments Industries	WT
Waste Incineration	WI
Management of Tailings and Waste-Rock in Mining Activities	MTWR
Pulp and Paper Industry	PP
Textiles Industry	TXT
Tanning of Hides and Skins	TAN
Slaughterhouses and Animals By-products Industries	SA
<i>Food, Drink and Milk Industries</i>	<i>FDM</i>
Intensive Rearing of Poultry and Pigs	ILF
Surface Treatment Using Organic Solvents	STS
Industrial Cooling Systems	CV
Emissions from Storage	ESB
Reference Document . . .	
General Principles of Monitoring	MON
Economics and Cross-Media Effects	ECM
Energy Efficiency Techniques	ENE

EXECUTIVE SUMMARY

Introduction

This Reference Document on Best Available Techniques (BREF) in the Food, drink and milk industries reflects an information exchange carried out according to Article 16.2 of Council Directive 96/61/EC. This executive summary describes the main findings, a summary of the principal BAT conclusions and the associated consumption and emission levels. It should be read together with the preface, which explains this document's objectives; how it is intended to be used and legal terms. This executive summary can be read and understood as a standalone document but, as a summary, it does not present all the complexities of the full text of this document. It is, therefore, not intended to be used, as a substitute for the text of this full document, as a tool in BAT decision making.

Scope

This document reflects an exchange of information about the activities listed in Annex 1 parts 6.4. (b) and (c) of Council Directive 96/61/EC of 24 September 1996 concerning integrated pollution prevention and control (IPPC Directive), i.e.

6.4. (b) *Treatment and processing intended for the production of food products from:*

- *animal raw materials (other than milk) with a finished product production capacity greater than 75 tonnes per day*
- *vegetable raw materials with a finished product production capacity greater than 300 tonnes per day (average value on a quarterly basis)*

(c) *Treatment and processing of milk, the quantity of milk received being greater than 200 tonnes per day (average value on an annual basis)*

The scope includes the whole range of activities producing food for human consumption and animal feed that may be found in European installations with capacities exceeding the above threshold values.

This document does not cover small scale activities, such as catering or activities in restaurants or activities that do not use animal or vegetable raw materials. Upstream activities such as agriculture, hunting, slaughtering of animals and the manufacture of non-food products such as soap, candles, cosmetics, pharmaceuticals; manufacture of gelatine and glue from hides, skin and bones are also excluded. Packaging is not included except for the packing of FDM products on the premises.

General information (Chapter 1)

The FDM sector

The FDM sector produces both finished products destined for consumption and intermediate products destined for further processing. It is diverse compared to many other industrial sectors. This diversity can be seen in terms of the size and nature of companies; the wide range of raw materials, products and processes and the numerous combinations of each as well as the production of homogenised global products and numerous specialist or traditional products on national and even regional scales. A large proportion of companies are SMEs, although most employ more than 20 people.

The FDM sector is subject to very diverse local economic, social and environmental conditions, and varying national legislation. The sector is spread all over Europe, in industrialised regions as well as in rural areas. The sector is a net exporter from the EU.

In spite of recent increased homogeneity in the consumption and purchasing patterns for a growing variety of goods, FDM products still retain elements of cultural specificity. So although consumers want to be able to purchase the same items and quality of products throughout the whole of the EU-15, they also demand the option/choice of different products linked to their own tradition or culture.

The importance of food safety in FDM processing

As well as environmental considerations, there are other legal requirements and prohibitions which must be considered when identifying BAT in the FDM sector. All FDM production installations must comply with the required food safety standards and laws. These may have an influence on environmental considerations, e.g. frequent cleaning is required and this uses heated water and detergents. Care has been taken to ensure that nothing in this document conflicts with relevant food safety and hygiene legislation.

The FDM sector and the environment

The most significant environmental issues associated with FDM installations are water consumption and contamination; energy consumption; and waste minimisation.

Most of the water which is not used as an ingredient ultimately appears in the waste water stream. Typically, untreated FDM waste water is high in both COD and BOD. Levels can be 10 – 100 times higher than in domestic waste water. The SS concentration varies from negligible to as high as 120000 mg/l. Untreated waste water from some sectors, e.g. meat, fish, dairy and vegetable oil production, contains high concentrations of FOG. High levels of phosphorus can also occur, particularly where large quantities of phosphoric acid are used in the process, e.g. for vegetable oil de-gumming, or in cleaning.

The FDM sector is dependent on energy for processing as well as for maintaining freshness and ensuring food safety.

The main sources of solid output are spillage, leakage, overflow, defects/returned products, inherent loss, retained material that cannot freely drain to the next stage in the process and heat deposited waste.

The main air pollutants from FDM processes are dust and odour. Odour is a local problem either related to the process or to the storage of raw materials, by-products or waste.

The driving forces which result in improved environmental performance are changing. For example, traditionally maximising the utilisation of materials has had the consequence of reducing waste. An approach more directly associated with protection of the environment is now emerging, although this challenges the sector, e.g. with respect to reducing water and energy consumption and the use of packaging, while still maintaining hygiene standards.

Applied processes and techniques (Chapter 2)

All of the processes used in the sector cannot be described in detail in this document, but it covers a very wide range from the whole sector. Chapter 2 is divided into two sections. Sections 2.1 – 2.1.9.6.3 describe processes at the unit operation level. Many of these are applied in several individual FDM sectors. The processes most commonly used in the FDM sector are described in nine categories, i.e. materials reception and preparation; size reduction, mixing and forming; separation techniques; product processing technology; heat processing; concentration by heat; processing by removal of heat; post processing operations; and utility processes. Within each of these categories, four to fourteen unit operations are described.

Sections 2.2 – 2.2.20 describe the application of the unit operations in some of the major individual FDM sectors.

Current consumption and emission levels (Chapter 3)

Chapter 3 follows the structure of Chapter 2. In this document, as well as reporting consumption and emission data, this chapter contains additional information about outputs that are not the main final product and are not disposed of as waste, e.g. by-products.

Sections 3.1 – 3.1.4 report some overall consumption and emission data for the FDM sector as a whole and give an overview of the main reasons for its consumption and emission characteristics. The FDM sector is a large user of water as an ingredient, cleaning agent, means of conveyance and feed to utility systems. About 66 % of the total fresh water used is of drinking water quality. In some sectors, e.g. dairies and drinks, up to 98 % of the fresh water used is of drinking water quality. Process heating uses approximately 29 % of the total energy used in the FDM sector. Process cooling and refrigeration accounts for about 16 % of the total energy used.

Sections 3.2 – 3.2.56.3 report some consumption and emission levels for those individual unit operations which are described in Chapter 2. This information is reported under the headings water, air emissions, solid output, energy and noise.

Sections 3.3 – 3.3.12.3 report consumption and emission data for some individual FDM sectors. This structure enables the reader to make a comparison between individual sectors and the sector as a whole, at unit operation level. A lot of the information is qualitative. The quantitative information is often not well explained in terms of exactly what operational or technological techniques were applied and what methods or conditions of data collection were applied. Data on air emissions and waste water production are available for some individual FDM sectors and even for some unit operations. Waste minimisation is generally considered as a cost effective goal for all manufacturers but benchmarks are not readily available as the percentage of raw materials going to the final main products is variable.

The level of detail reported for each individual sector varies to a great extent.

Techniques to consider in the determination of BAT (Chapter 4)

Chapter 4 contains the detailed information used by the TWG to determine BAT for the FDM sector, but does not judge whether a technique is BAT or not. It follows the general structure of Chapters 2 and 3 by starting with information applicable to all or some of the FDM sectors and finishing with individual FDM sector specific information.

Over 370 techniques are described, generally under the standard headings Description, Achieved environmental benefits, Cross-media effects, Operational data, Applicability, Economics, Driving force for implementation, Example plants and Reference literature. The standard structure assists the comparison of techniques both qualitatively and quantitatively.

This chapter includes both “process-integrated” and “end-of-pipe” techniques. Most of the techniques are reported to have more than one environmental benefit and some have cross-media effects. Many address the issues of minimising water consumption and contamination; energy consumption and maximising the use of raw materials with the consequent minimisation of waste production. For many, no financial costs or benefit data were provided, but their actual application provides evidence of their economic viability.

Techniques which are applicable in all FDM installations are described first, in Sections 4.1 - 4.1.9.3. These include operational practices, i.e. management tools; training; equipment and installation design; maintenance and a methodology for preventing and minimising the consumption of water and energy and the production of waste. Other techniques are more technical and deal with production management, process control techniques and the selection of materials. General storage techniques are not reported because these are within the scope of the “Storage BREF” [95, EC, 2005]. Specific techniques related to food storage, which minimise energy consumption for refrigeration, waste and odour associated with degradation of food, are included.

Techniques which apply in a number of FDM sectors are then described in Sections 4.2 - 4.2.17.4. These deal with the way some specific unit operations which are described in Chapter 2 are applied.

Cleaning of equipment and installations is described in Sections 4.3 – 4.3.11. The selection and use of cleaning and disinfection agents must ensure effective hygiene control but with due consideration of environmental implications.

End-of-pipe techniques for minimising air emissions and for waste water treatment are described in Sections 4.4 – 4.4.3.13.2 and 4.5 – 4.5.7.9 respectively. The introductions to these sections reinforce the importance of giving priority to process-integrated techniques to prevent and reduce, as far as possible, air and waste water emissions. When end-of-pipe techniques are needed, these are designed to reduce both the concentrations and the flows of the pollutants originating from a unit operation or a process. The techniques described for minimising air emissions do not contain much information about their applicability or application in the individual FDM sectors. In contrast, the waste water treatment techniques contain more information about their applicability or application in the individual FDM sectors and address the treatment of typical emissions from FDM installations, containing high BOD, COD, FOG, nitrogen and phosphorus levels.

Sections 4.6 – 4.6.6 address the prevention of accidents at FDM installations. These sections describe a methodology for preventing accidents and minimising their impact on the environment.

Techniques which are only applicable in individual FDM sectors are described in Sections 4.7 - 4.7.9.8.2. Most of these apply to specific unit operations in the individual FDM sectors.

Best available techniques (Chapter 5)

The way the BAT conclusions are presented in Chapter 5 is shown in the figure below. The BAT conclusions are presented in two tiers. The first tier shows the sections listing BAT for all FDM installations and the second tier shows the sections where additional BAT for some of the individual sectors are listed. Chapter 5 follows the same structure as Chapter 4. Many of the BAT are operational and, therefore, require very little investment in new equipment. Their application may require some investment to provide, e.g. training, maintenance or ongoing monitoring and review of performance levels.

The conclusions represent what the TWG considered to be BAT in a general sense for the FDM sector based on the information in Chapter 4 and taking account of the Article 2.11 definition of “best available techniques” and the considerations listed in Annex IV to the Directive. This chapter does not set consumption and emission limit values but gives information for the guidance of industry, MSs and the public on achievable consumption and emission levels when using specified techniques.

The following paragraphs summarise the key BAT conclusions relating to the most relevant environmental issues. Very few of the BAT provide only one environmental benefit, so they are not listed according to environmental issues. The BAT take various approaches to protect the environment as a whole. These range from techniques about general management and operation, which are applicable throughout all FDM installations, to the use of very specific technology in some individual FDM sectors.

During the discussion of the information exchanged by the TWG, many issues were raised and discussed. Only some of them are highlighted in this summary and it should not be read instead of the “Best Available Techniques” chapter, which should not be read in isolation from the rest of this document.

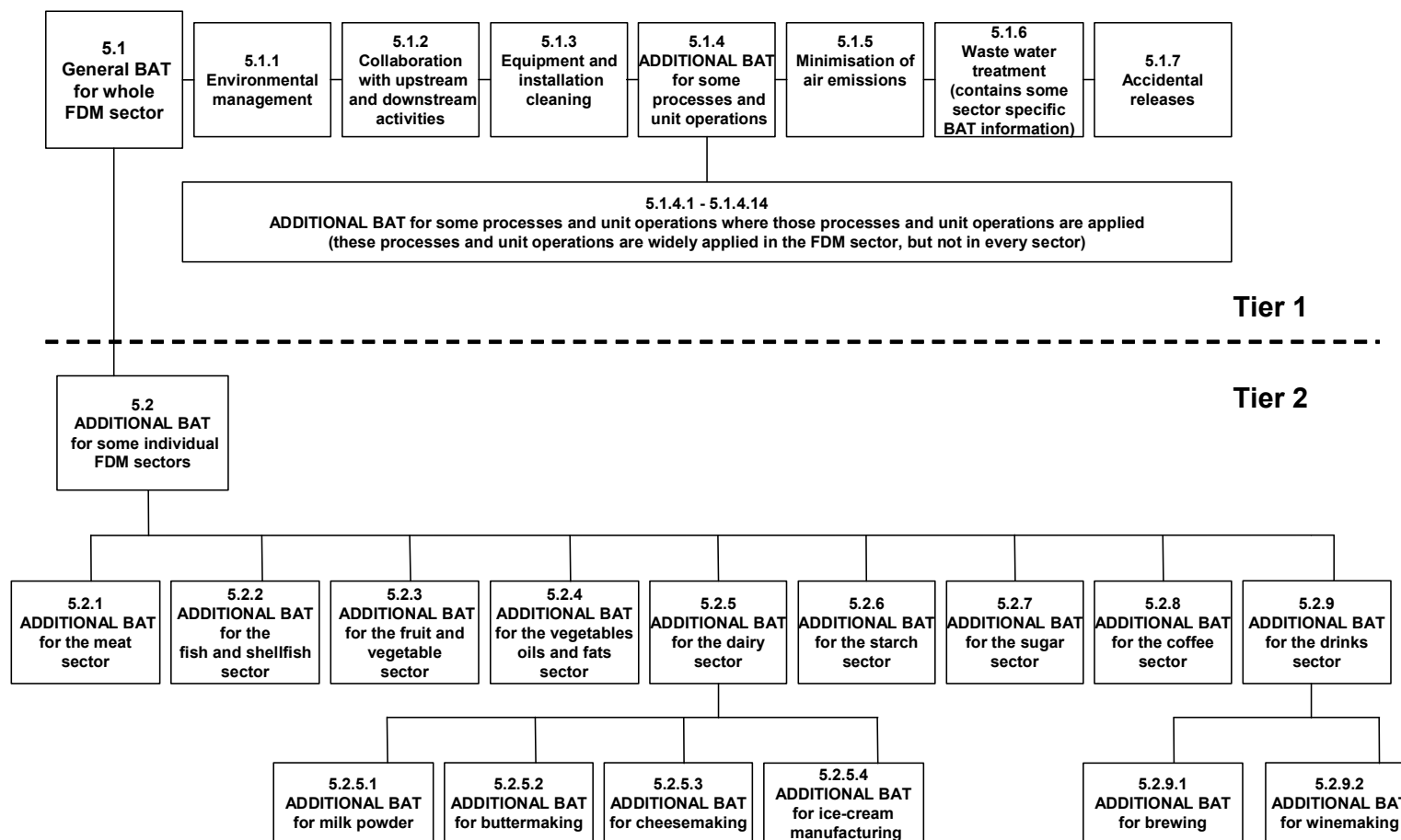

How the BAT conclusions are presented for FDM installations

General BAT for the whole FDM sector

Although the FDM sector is diverse, the individual sectors have common issues, e.g. similar key environmental issues and the same BAT are applicable to preventing and controlling consumptions and emissions, e.g. dry cleaning, to minimise, e.g. water consumption. Also, some BAT can be applied to more than one environmental issue, e.g. maintenance of refrigeration equipment to prevent leaks of ammonia or maintenance of fish skinning machinery to minimise waste caused by unwanted removal of fish flesh during skinning.

General management

The general management BAT contribute to the overall minimisation of consumption and emission levels, by providing systems of work which encourage good practice and raise awareness. The BAT focus on issues such as using an environmental management system; providing training; using a planned maintenance programme; applying and maintaining a methodology for preventing and minimising the consumption of water and energy and the production of waste and implementing a system for monitoring and reviewing consumption and emission levels for both individual production processes and at site level.

General operation

Other BAT address some key environmental issues more directly, e.g. by transporting solid FDM raw materials, products, co-products, by-products and waste dry. This reduces water consumption and consequently also reduces waste water production and pollution. It also increases the potential for the recovery and recycling of substances generated in the process which, in many cases, can be sold for use as animal feed, so it reduces waste production.

Another example applicable to the whole FDM sector is the segregation of outputs, to optimise use, re-use, recovery, recycling and disposal and minimise waste water contamination. Numerous examples exist in the FDM sector where raw materials, partially processed foods and final products either originally intended for human consumption or from which the part intended for human consumption has been removed, may be used as animal feed. This has both environmental and economic benefits.

General application of technology

Some more technologically based BAT include the application and use of process controls, e.g. by using analytical measurement and control techniques to reduce waste of material and water and to reduce waste water generation in processing and cleaning. An example of this is measuring turbidity to monitor process water quality and to optimise both the recovery of material/product from water and the re-use of cleaning water.

Collaboration with upstream and downstream partners

The operations of those involved in the supply of raw materials and other ingredients to FDM processing installations, including the farmers and the hauliers, can have environmental consequences in those FDM installations. Likewise, the FDM installation can affect the environmental impact of those downstream installations they supply, including other FDM installations. BAT are to seek collaboration with upstream and downstream partners, to create a chain of environmental responsibility, to minimise pollution and to protect the environment as a whole, e.g. by providing fresh materials at the time they are required, which minimises the energy required to store them as well as waste and odour associated with their decomposition.

Equipment and installation cleaning

The application of BAT for cleaning, minimise water consumption and contamination; waste generation; energy consumption and the amount and harmfulness of detergents used.

In common with other BAT, the BAT for cleaning minimise the contact between water and FDM materials, by, e.g. optimising the use of dry cleaning. The environmental benefits include reduced water consumption and volume of waste water; reduced entrainment of materials in waste water and, therefore, reduced levels of, e.g. COD and BOD. Use of the various dry cleaning techniques increases the potential for the recovery and recycling of substances generated in the process. It also reduces the use of energy needed to heat water for cleaning and the use of detergents.

Other BAT associated with cleaning include cleaning-in-place of closed equipment, minimising the use of EDTA and avoiding the use of halogenated oxidising biocides.

Additional BAT for some processes and unit operations applied in a number of FDM sectors

The TWG reached BAT conclusions for some of the individual unit operations which are applied in a number, but usually not all, of the individual FDM sectors. BAT are listed for materials reception/despatch; centrifugation/separation; smoking; cooking; frying; preservation in cans, bottles and jars; evaporation; freezing and refrigeration; packing; energy generation and use; water use; compressed air systems and steam systems. The application of many of these BAT achieves reduced energy consumption, e.g. by using multi-effect evaporators, optimising vapour recompression related to heat and power availability in the installation, to concentrate liquids. Many reduce energy consumption by optimising operating conditions. Some reduce emissions to air. For example in smoking, BAT is to achieve a TOC air emission level of <math><50 \text{ mg/Nm}^3</math>.

Minimisation of air emissions and waste water treatment

Process-integrated BAT which minimise emissions to air and water by the selection and use of substances and techniques should be applied. The selection of air emission abatement and waste water treatment techniques can then be made, if further control is required. For example, BAT is to optimise the use of dry cleaning and this reduces the volume of waste water and the mass flow of solid food materials in it, so also reducing the requirement for waste water treatment.

BAT is to apply an air emissions control strategy and, unless specified otherwise in the BAT chapter, where process-integrated BAT which minimise air emissions by the selection and use of substances and the application of techniques do not achieve emission levels of 5 - 20 mg/Nm³ for dry dust, 35 – 60 mg/Nm³ for wet/sticky dust and <math><50 \text{ mg/Nm}^3</math> TOC, to achieve these levels by applying abatement techniques.

No overall conclusions were reached about whether it is better to treat waste water from FDM installations on-site or off-site, except for some primary techniques.

Unless otherwise stated in the BAT chapter, the emission levels given in the following table are indicative of the emission levels that would be achieved with those techniques generally considered to represent BAT. They do not necessarily represent levels currently achieved within the industry but are based on the expert judgement of the TWG.

Parameter	Concentration (mg/l)
BOD ₅	<25
COD	<125
TSS	<50
pH	6 – 9
Oil and grease	<10
Total nitrogen	<10
Total phosphorus	0.4 – 5
Better levels of BOD ₅ and COD can be obtained. It is not always possible or cost effective to achieve the total nitrogen and phosphorus levels shown, in view of local conditions.	

Typical FDM waste water quality after treatment

One MS has registered a split view. It does not agree with the footnote in the table shown above, because it believes that deviations from BAT, e.g. due to local conditions, are exclusively allowed to strengthen the requirements of permits.

Accidental releases

Several BAT are listed related to identifying potential accidents, risk assessments, implementing controls, developing and testing emergency plans and learning from past accidents and near misses.

Additional BAT for some individual FDM sectors

Additional BAT have been determined for the some individual FDM sectors. The general BAT in Sections 5.1 – 5.1.7 apply to these sectors and to the other sectors for which no additional BAT have been determined. The application of, e.g. general BAT such as segregation of outputs and optimising the use of dry cleaning can significantly reduce the overall environmental impact of a process.

The additional BAT for the meat and poultry sector apply to specific unit operations applied in some parts of that sector. They reduce the consumption of water, energy and packaging.

The main environmental benefits of the additional BAT for the fish and shellfish sector are reduced waste and less water consumption and several apply to the thawing, scaling, skinning, eviscerating and filleting of fish. For example, BAT have been determined for thawing mackerel to achieve a water consumption of <2 m³/t of raw fish; for thawing whitefish to achieving a water consumption of 1.8 – 2.2 m³/t of raw fish and to thaw shrimps and prawns by one or other of the two techniques using filtered peeling water.

For the fruit and vegetables sector, the BAT address storage, dry separation of rejected raw material, collection of soil, peeling, blanching and optimising water re-use. Application of the BAT lead to maximised production yield; material not used in the main product being used for other purposes, often as animal feed and consequently reduced waste generation. The environmental benefits of applying the BAT for storage, peeling and blanching include, e.g. reducing energy consumption.

The environmental benefits of applying the additional BAT for the vegetable oils and fats sector are mainly the reduction of energy consumption and the recovery of hexane used during extraction. One BAT associated emission level was determined, i.e. BAT is to use cyclones, to reduce wet dust emissions arising from vegetable oil extraction, to achieve a wet dust emission level of <50 mg/Nm³.

There are additional BAT for dairies and specific BAT for producing market milk, powdered milk, butter, cheese and ice-cream. The BAT apply to specific parts of the processes and to cleaning. They address water consumption, energy consumption and waste prevention. There are both operational and technological BAT. Consumption and emission levels indicative of the levels that can be achieved by applying in-process BAT have been determined, based on achieved levels reported by the TWG. These ranges are shown in the following table. The ranges reflect a variety of operating conditions. Energy consumption levels may vary due to, e.g. production volumes. Warm climates may use more energy for cooling and vice versa. Water consumption and waste water emission levels may vary due to, e.g. different product portfolios, batch sizes and cleaning. The waste water emission level may be lower compared to the water consumption level because many dairies measure the intake of cooling water, but then discharge it unmeasured. In warm climates, water may be lost due to evaporation.

	Energy consumption	Water consumption	Waste water
Production of market milk from 1 litre of received milk	0.07 – 0.2 kWh/l	0.6 – 1.8 l/l	0.8 – 1.7 l/l
Production of milk powder from 1 litre of received milk	0.3 – 0.4 kWh/l	0.8 – 1.7 l/l	0.8 – 1.5 l/l
Production of 1 kg of ice-cream	0.6 – 2.8 kWh/kg	4.0 – 5.0 l/kg	2.7 – 4.0 l/kg

Consumption and emission levels associated with some dairy processes

The application of the additional BAT for starch manufacturing mainly address reducing water consumption and waste water production, especially by re-using water.

Re-use of water is also addressed by the BAT for the sugar sector. Minimising energy consumption is also achieved by avoiding drying sugar beet pulp if an outlet is available for pressed sugar beet pulp, e.g. animal feed; otherwise to dry sugar beet pulp using steam driers or using high temperature driers combined with measures to reduce emissions to air.

The main environmental issues addressed by the application of the additional BAT for the coffee sector are related to energy consumption and emissions to air, including odour. When roasting coffee, where process-integrated BAT which minimise air emissions by the selection and use of substances and the application of techniques do not achieve emission levels of 5 - 20 mg/Nm³ for dry dust; <50 mg/Nm³ TOC for light roasted coffee (this level is more difficult to achieve as the darkness of roasting is increased); BAT is to achieve these levels by applying abatement techniques. Emission levels for NO_x were provided too late for full verification by the TWG, these are reported in the concluding remarks.

The additional general BAT for drinks manufacturing address avoiding production of CO₂ directly from fossil fuels, recovery of yeast, collection of spent filter material and the selection and optimised use of bottle cleaning machines. Application of the additional BAT for brewing reduce both water and energy consumption. For brewing, BAT is to achieve a water consumption level of 0.35 – 1 m³/hl of beer produced. The application of the additional BAT for winemaking re-uses the alkaline solution used for cleaning after cold stabilisation and addresses the method of its ultimate disposal to prevent disruption of the waste water treatment plant.

Emerging techniques (Chapter 6)

Chapter 6 includes one technique that has not yet been commercially applied and is still in the research or development phase. This is “Use of UV/ozone in absorption for odour abatement”. It has been included here to raise awareness for any future revision of this document.

Concluding remarks (Chapter 7)

Timing of the work

The work on this document started with the first plenary meeting of the TWG in January 2001. The final plenary meeting of the TWG was held in February 2005.

Level of consensus, driving forces and issues arising from the final TWG meeting

The conclusions of the work were agreed at the final plenary meeting, with a high level of consensus being achieved, however some issues were raised at the meeting and it is recommended that these be considered further when this document is reviewed.

Information provided

Many reports from MSs and industry were used as sources of information in the drafting of this document, including information from example plants and site visits. The participation of individual MSs in the work, to an extent, reflected the regional distribution of the sectors. CIAA and its member organisations provided most of the industry contributions.

The information exchange and the preparation of this document has been a positive development in the prevention and control of pollution for the sectors concerned. It has provided a first-time opportunity for individual sectors to learn about techniques that have been proven to work well in others, on a Europe-wide scale.

Information imbalances and gaps

There is a vast difference in the level of detail of information provided about individual FDM sectors and there are also differences in the coverage of the key environmental issues in this document. The current consumption and emission level data provided were not linked with process descriptions, operating conditions, installation capacity, sampling and analytical methods and statistical presentations. Techniques which can reduce energy consumption are described in this document, but very few actual measurements of energy savings associated with the application of those techniques or about the economics of investing in techniques and the resultant cost savings were provided. Benchmarks for waste minimisation are not provided, e.g. there is no detailed information about what proportion of specified raw materials end up being used in products or by-products.

Recommendations for future work

The gaps in the information indicate areas where future work could provide results which might assist in the identification of BAT when this document is reviewed, thereby helping operators and permit writers to protect the environment as a whole. It is recommended that information be provided about the following:

- process descriptions, operating conditions, sampling and analytical methods, and statistical presentations associated with consumption and emission level data
- the full range of applicability of techniques in this document
- further opportunities for by-product valorisation to minimise waste generation
- the costs of investing in and operating techniques and the associated direct and indirect savings, e.g. due to reduced energy or waste disposal costs, or reduced losses from unintentional losses due to leakage or spills
- the determination of BAT associated with high, medium and low pressure cleaning
- substances already in use as alternatives to EDTA in cleaning
- the application and applicability of air abatement techniques in the FDM sector
- the application of non-thermal plasma treatment of odours in the FDM sector
- techniques to prevent the discharge of condensed alcohol into the waste water treatment plant, from the production of non-alcoholic beer
- how seasonal activities affect the technical and economic viability of techniques
- techniques for extracting olive oil and in particular about “two-phase extraction”
- the use of enzymatic interestification and enzymatic degumming of vegetable oils
- comparative information about the degumming of vegetable oils using enzymes, phosphoric acid and citric acid
- techniques used to minimise NO_x emissions from coffee roasting installations and
- the selection and use of fumigants.

Suggested topics for future R&D projects

The following topics are suggested for future research and development projects:

- the composition and harmfulness of malodorous emissions from FDM installations
- identification of techniques to reduce the lowest levels of NO_x emissions reported from coffee roasting
- identification of alternatives to using EDTA as a cleaning agent and
- the environmental benefits and costs of reverse osmosis.

The EC is launching and supporting, through its RTD programmes, a series of projects dealing with clean technologies, emerging effluent treatment and recycling technologies, and management strategies. Potentially these projects could provide a useful contribution to future BREF reviews. Readers are, therefore, invited to inform the EIPPCB of any research results which are relevant to the scope of this document (see also the Preface of this document).

PREFACE

1. Status of this document

Unless otherwise stated, references to “the Directive” in this document means the Council Directive 96/61/EC on integrated pollution prevention and control. As the Directive applies without prejudice to Community provisions on health and safety at the workplace, so does this document.

This document forms part of a series presenting the results of an exchange of information between EU Member States and industries concerned on best available technique (BAT), associated monitoring, and developments in them. It is published by the European Commission pursuant to Article 16(2) of the Directive, and must therefore be taken into account in accordance with Annex IV of the Directive when determining “best available techniques”.

2. Relevant legal obligations of the IPPC Directive and the definition of BAT

In order to help the reader understand the legal context in which this document has been drafted, some of the most relevant provisions of the IPPC Directive, including the definition of the term “best available techniques”, are described in this preface. This description is inevitably incomplete and is given for information only. It has no legal value and does not in any way alter or prejudice the actual provisions of the Directive.

The purpose of the Directive is to achieve integrated prevention and control of pollution arising from the activities listed in its Annex I, leading to a high level of protection of the environment as a whole. The legal basis of the Directive relates to environmental protection. Its implementation should also take account of other Community objectives such as the competitiveness of the Community’s industry thereby contributing to sustainable development.

More specifically, it provides for a permitting system for certain categories of industrial installations requiring both operators and regulators to take an integrated, overall look at the polluting and consuming potential of the installation. The overall aim of such an integrated approach must be to improve the management and control of industrial processes so as to ensure a high level of protection for the environment as a whole. Central to this approach is the general principle given in Article 3 that operators should take all appropriate preventative measures against pollution, in particular through the application of best available techniques enabling them to improve their environmental performance.

The term “best available techniques” is defined in Article 2(11) of the Directive as “the most effective and advanced stage in the development of activities and their methods of operation which indicate the practical suitability of particular techniques for providing in principle the basis for emission limit values designed to prevent and, where that is not practicable, generally to reduce emissions and the impact on the environment as a whole.” Article 2(11) goes on to clarify further this definition as follows:

“techniques” includes both the technology used and the way in which the installation is designed, built, maintained, operated and decommissioned;

“available” techniques are those developed on a scale which allows implementation in the relevant industrial sector, under economically and technically viable conditions, taking into consideration the costs and advantages, whether or not the techniques are used or produced inside the Member States in question, as long as they are reasonably accessible to the operator;

“best” means most effective in achieving a high general level of protection of the environment as a whole.

Furthermore, Annex IV of the Directive contains a list of “considerations to be taken into account generally or in specific cases when determining best available techniques ... bearing in mind the likely costs and benefits of a measure and the principles of precaution and prevention”. These considerations include the information published by the Commission pursuant to Article 16(2).

Competent authorities responsible for issuing permits are required to take account of the general principles set out in Article 3 when determining the conditions of the permit. These conditions must include emission limit values, supplemented or replaced where appropriate by equivalent parameters or technical measures. According to Article 9(4) of the Directive, these emission limit values, equivalent parameters and technical measures must, without prejudice to compliance with environmental quality standards, be based on the best available techniques, without prescribing the use of any technique or specific technology, but taking into account the technical characteristics of the installation concerned, its geographical location and the local environmental conditions. In all circumstances, the conditions of the permit must include provisions on the minimisation of long distance or transboundary pollution and must ensure a high level of protection for the environment as a whole.

Member States have the obligation, according to Article 11 of the Directive, to ensure that competent authorities follow, or are informed of, developments in best available techniques.

3. Objective of this document

Article 16(2) of the Directive requires the Commission to organise “an exchange of information between Member States and the industries concerned on best available techniques, associated monitoring and developments in them”, and to publish the results of the exchange.

The purpose of the information exchange is given in recital 25 of the Directive, which states that “the development and exchange of information at Community level about best available techniques will help to redress the technological imbalances in the Community, will promote the worldwide dissemination of limit values and techniques used in the Community and will help the Member States in the efficient implementation of this Directive.”

The Commission (Environment DG) established an information exchange forum (IEF) to assist with the work under Article 16(2) and a number of technical working groups have been established under the umbrella of the IEF. Both the IEF and the technical working groups include representation from Member States and industry as required in Article 16(2).

The aim of this series of documents is to reflect accurately the exchange of information which has taken place as required by Article 16(2) and to provide reference information for the permitting authority to take into account when determining permit conditions. By providing relevant information concerning best available techniques, these documents should act as valuable tools to drive environmental performance.

4. Information sources

This document represents a summary of information collected from a number of sources, including in particular the expertise of the groups established to assist the Commission in its work, and verified by the Commission services. All contributions are gratefully acknowledged.

5. How to understand and use this document

The information provided in this document is intended to be used as an input to the determination of BAT in specific cases. When determining BAT and setting BAT-based permit conditions, account should always be taken of the overall goal to achieve a high level of protection for the environment as a whole.

The rest of this section describes the type of information that is provided in each section of the document.

Chapters 1 and 2 provide general information on the industrial sector concerned and on the industrial processes used within the sector. Chapter 3 provides data and information concerning current consumption and emission levels and the production and use of by-products of the main processes, reflecting the situation in existing installations at the time of writing.

Chapter 4 describes in more detail the emission reduction and other techniques that are considered to be most relevant for determining BAT and BAT-based permit conditions. This information includes the consumption and emission levels considered achievable by using the technique, some idea of the costs and the cross-media issues associated with the technique, and the extent to which the technique is applicable to the range of installations requiring IPPC permits, e.g. new, existing, large or small installations. Techniques that are generally seen as obsolete are not included.

Chapter 5 presents the techniques and the consumption and emission levels that are considered to be compatible with BAT in a general sense. The purpose is thus to provide general indications regarding the consumption and emission levels that can be considered as an appropriate reference point to assist in the determination of BAT-based permit conditions or for the establishment of general binding rules under Article 9(8). It should be stressed, however, that this document does not propose emission limit values. The determination of appropriate permit conditions will involve taking account of local, site-specific factors such as the technical characteristics of the installation concerned, its geographical location and the local environmental conditions. In the case of existing installations, the economic and technical viability of upgrading them also needs to be taken into account. Even the single objective of ensuring a high level of protection for the environment as a whole will often involve making trade-off judgements between different types of environmental impact, and these judgements will often be influenced by local considerations.

Although an attempt is made to address some of these issues, it is not possible for them to be considered fully in this document. The techniques and levels presented in Chapter 5 will therefore not necessarily be appropriate for all installations. On the other hand, the obligation to ensure a high level of environmental protection including the minimisation of long-distance or transboundary pollution implies that permit conditions cannot be set on the basis of purely local considerations. It is therefore of the utmost importance that the information contained in this document is fully taken into account by permitting authorities.

Since the best available techniques change over time, this document will be reviewed and updated as appropriate. All comments and suggestions should be made to the European IPPC Bureau at the Institute for Prospective Technological Studies at the following address:

Edificio Expo; c/Inca Garcilaso, s/n; E-41092 Seville, Spain
Telephone: +34 95 4488 284
Fax: +34 95 4488 426
e-mail: JRC-IPTS-EIPPCB@ec.europa.eu
Internet: <http://eippcb.jrc.es>

Best Available Techniques Reference Document on Food, Drink and Milk

EXECUTIVE SUMMARY	I
PREFACE	XI
SCOPE.....	XLI
1 GENERAL INFORMATION	1
1.1 Description, turnover, growth, employment	1
1.2 Sector structure	3
1.3 Trade	3
1.4 Market forces: demand, distribution and competition	4
1.4.1 Demand	4
1.4.2 Distribution.....	4
1.4.3 Competition	4
1.5 The importance of food safety in FDM processing	4
1.6 Legislative framework for food, drink and milk products	5
1.7 The FDM sector and the environment	5
1.7.1 Key environmental issues	6
2 APPLIED PROCESSES AND TECHNIQUES	9
2.1 Processing techniques and unit operations	9
2.1.1 Materials reception and preparation (A)	10
2.1.1.1 Materials handling and storage (A.1).....	10
2.1.1.1.1 Objective.....	10
2.1.1.1.2 Field of application	10
2.1.1.1.3 Description of techniques, methods and equipment.....	11
2.1.1.2 Sorting/screening, grading, dehulling, destemming/destalking and trimming (A.2)	11
2.1.1.2.1 Objective.....	11
2.1.1.2.2 Field of application	11
2.1.1.2.3 Description of techniques, methods and equipment.....	11
2.1.1.3 Peeling (A.3).....	12
2.1.1.3.1 Objective.....	12
2.1.1.3.2 Field of application	12
2.1.1.3.3 Description of techniques, methods and equipment.....	12
2.1.1.4 Washing (A.4)	12
2.1.1.4.1 Objective.....	12
2.1.1.4.2 Field of application	13
2.1.1.4.3 Description of techniques, methods and equipment.....	13
2.1.1.5 Thawing (A.5)	13
2.1.1.5.1 Objective.....	13
2.1.1.5.2 Field of application	13
2.1.1.5.3 Description of techniques, methods and equipment.....	13
2.1.2 Size reduction, mixing and forming (B)	13
2.1.2.1 Cutting, slicing, chopping, mincing, pulping and pressing (B.1).....	13
2.1.2.1.1 Objective.....	13
2.1.2.1.2 Field of application	13
2.1.2.1.3 Description of techniques, methods and equipment.....	14
2.1.2.2 Mixing/blending, homogenisation and conching (B.2)	15
2.1.2.2.1 Objective.....	15
2.1.2.2.2 Field of application	15
2.1.2.2.3 Description of techniques, methods and equipment.....	15
2.1.2.3 Grinding/milling and crushing (B.3).....	16
2.1.2.3.1 Objective.....	16
2.1.2.3.2 Field of application	16
2.1.2.3.3 Description of processing techniques, methods and equipment.....	16
2.1.2.4 Forming/moulding and extruding (B.4).....	16
2.1.2.4.1 Objective.....	16
2.1.2.4.2 Field of application	16
2.1.2.4.3 Description of techniques, methods and equipment.....	17

2.1.3	Separation techniques (C)	17
2.1.3.1	Extraction (C.1)	17
2.1.3.1.1	Objective	17
2.1.3.1.2	Field of application	17
2.1.3.1.3	Description of techniques, methods and equipment	17
2.1.3.2	Deionisation (C.2)	18
2.1.3.2.1	Objective	18
2.1.3.2.2	Field of application	18
2.1.3.2.3	Description of techniques, methods and equipment	18
2.1.3.3	Fining (C.3)	18
2.1.3.3.1	Objective	18
2.1.3.3.2	Field of application	18
2.1.3.3.3	Description of techniques, methods and equipment	18
2.1.3.4	Centrifugation and sedimentation (C.4)	19
2.1.3.4.1	Objective	19
2.1.3.4.2	Field of application	19
2.1.3.4.3	Description of techniques, methods and equipment	19
2.1.3.5	Filtration (C.5)	20
2.1.3.5.1	Objective	20
2.1.3.5.2	Field of application	20
2.1.3.5.3	Description of techniques, methods and equipment	20
2.1.3.6	Membrane separation (C.6)	21
2.1.3.6.1	Objective	21
2.1.3.6.2	Field of application	21
2.1.3.6.3	Description of techniques, methods and equipment	22
2.1.3.7	Crystallisation (C.7)	22
2.1.3.7.1	Objective	22
2.1.3.7.2	Field of application	22
2.1.3.7.3	Description of the technique, methods and equipment	22
2.1.3.8	Removal of free fatty acids (ffa) by neutralisation (C.8)	22
2.1.3.8.1	Objective	22
2.1.3.8.2	Field of application	23
2.1.3.8.3	Description of techniques, methods and equipment	23
2.1.3.9	Bleaching (C.9)	23
2.1.3.9.1	Objective	23
2.1.3.9.2	Field of application	23
2.1.3.9.3	Description of techniques, methods and equipment	24
2.1.3.10	Deodorisation by steam stripping (C.10)	24
2.1.3.10.1	Objective	24
2.1.3.10.2	Field of application	24
2.1.3.10.3	Description of techniques, methods and equipment	24
2.1.3.11	Decolourisation (C.11)	24
2.1.3.11.1	Objective	24
2.1.3.11.2	Field of application	24
2.1.3.11.3	Description of techniques, methods and equipment	24
2.1.3.12	Distillation (C.12)	25
2.1.3.12.1	Objective	25
2.1.3.12.2	Field of application	25
2.1.3.12.3	Description of techniques, methods and equipment	25
2.1.4	Product processing technology (D)	26
2.1.4.1	Soaking (D.1)	26
2.1.4.1.1	Objective	26
2.1.4.1.2	Field of application	26
2.1.4.1.3	Description of techniques, methods and equipment	26
2.1.4.2	Dissolving (D.2)	27
2.1.4.2.1	Objective	27
2.1.4.2.2	Field of application	27
2.1.4.2.3	Description of techniques, methods and equipment	27
2.1.4.3	Solubilisation/alkalising (D.3)	27
2.1.4.3.1	Objective	27
2.1.4.3.2	Field of application	27
2.1.4.3.3	Description of techniques, methods and equipment	27
2.1.4.4	Fermentation (D.4)	28

2.1.4.4.1	Objective.....	28
2.1.4.4.2	Field of application	28
2.1.4.4.3	Description of techniques, methods and equipment.....	28
2.1.4.5	Coagulation (D.5)	29
2.1.4.5.1	Objective.....	29
2.1.4.5.2	Field of application	29
2.1.4.5.3	Description of technique, methods and equipment	29
2.1.4.6	Germination (D.6).....	29
2.1.4.6.1	Objective.....	29
2.1.4.6.2	Field of application	29
2.1.4.6.3	Description of processing techniques, methods and equipment.....	30
2.1.4.7	Brining/curing and pickling (D.7).....	30
2.1.4.7.1	Objective.....	30
2.1.4.7.2	Field of application	30
2.1.4.7.3	Description of techniques, methods and equipment.....	30
2.1.4.8	Smoking (D.8)	31
2.1.4.8.1	Objective.....	31
2.1.4.8.2	Field of application	31
2.1.4.8.3	Description of techniques, methods and equipment.....	31
2.1.4.9	Hardening (D.9).....	31
2.1.4.9.1	Objective.....	31
2.1.4.9.2	Field of application	32
2.1.4.9.3	Description of techniques, methods and equipment.....	32
2.1.4.10	Sulphitation (D.10)	32
2.1.4.10.1	Objective.....	32
2.1.4.10.2	Field of application	32
2.1.4.10.3	Description of techniques, methods and equipment.....	32
2.1.4.11	Carbonatation (D.11)	32
2.1.4.11.1	Objective.....	32
2.1.4.11.2	Field of application	32
2.1.4.11.3	Description of techniques, methods and equipment.....	33
2.1.4.12	Carbonation (D.12).....	33
2.1.4.12.1	Objective.....	33
2.1.4.12.2	Field of application	33
2.1.4.12.3	Description of techniques, methods and equipment.....	33
2.1.4.13	Coating/spraying/enrobing/agglomeration/encapsulation (D.13)	34
2.1.4.13.1	Objective.....	34
2.1.4.13.2	Field of application	34
2.1.4.13.3	Description of techniques, methods and equipment.....	34
2.1.4.14	Ageing (D.14).....	34
2.1.4.14.1	Objective.....	34
2.1.4.14.2	Field of application	34
2.1.4.14.3	Description of techniques, methods and equipment.....	34
2.1.5	Heat processing (E)	35
2.1.5.1	Melting (E.1)	35
2.1.5.1.1	Objective.....	35
2.1.5.1.2	Field of application	35
2.1.5.1.3	Description of techniques, methods and equipment.....	35
2.1.5.2	Blanching (E.2).....	35
2.1.5.2.1	Objective.....	35
2.1.5.2.2	Field of application	35
2.1.5.2.3	Description of techniques, methods and equipment.....	35
2.1.5.3	Cooking and boiling (E.3)	35
2.1.5.3.1	Objective.....	35
2.1.5.3.2	Field of application	36
2.1.5.3.3	Description of techniques, methods and equipment.....	36
2.1.5.4	Baking (E.4).....	36
2.1.5.4.1	Objective.....	36
2.1.5.4.2	Field of application	36
2.1.5.4.3	Description of techniques, methods and equipment.....	36
2.1.5.5	Roasting (E.5).....	37
2.1.5.5.1	Objective.....	37
2.1.5.5.2	Field of application	37

2.1.5.5.3	Description of techniques, methods and equipment	37
2.1.5.6	Frying (E.6)	38
2.1.5.6.1	Objective	38
2.1.5.6.2	Field of application.....	38
2.1.5.6.3	Description of techniques, methods and equipment	38
2.1.5.7	Tempering (E.7)	38
2.1.5.7.1	Objective	38
2.1.5.7.2	Field of application.....	38
2.1.5.7.3	Description of techniques, methods and equipment	39
2.1.5.8	Pasteurisation, sterilisation and UHT (E.8).....	39
2.1.5.8.1	Objective	39
2.1.5.8.2	Field of application.....	39
2.1.5.8.3	Description of techniques, methods and equipment	40
2.1.6	Concentration by heat (F)	41
2.1.6.1	Evaporation (liquid to liquid) (F.1)	41
2.1.6.1.1	Objective	41
2.1.6.1.2	Field of application.....	41
2.1.6.1.3	Description of techniques, methods and equipment	41
2.1.6.2	Drying (liquid to solid) (F.2).....	42
2.1.6.2.1	Objective	42
2.1.6.2.2	Field of application.....	42
2.1.6.2.3	Description of techniques, methods and equipment	42
2.1.6.3	Dehydration (solid to solid) (F.3).....	43
2.1.6.3.1	Objective	43
2.1.6.3.2	Field of application.....	43
2.1.6.3.3	Description of techniques, methods and equipment	43
2.1.7	Processing by the removal of heat (G)	45
2.1.7.1	Cooling, chilling and cold stabilisation (G.1)	45
2.1.7.1.1	Objective	45
2.1.7.1.2	Field of application.....	45
2.1.7.1.3	Description of techniques, methods and equipment	45
2.1.7.2	Freezing (G.2)	46
2.1.7.2.1	Objective	46
2.1.7.2.2	Field of application.....	46
2.1.7.2.3	Description of techniques, methods and equipment	46
2.1.7.3	Freeze-drying/lyophilisation (G.3).....	47
2.1.7.3.1	Objective	47
2.1.7.3.2	Field of application.....	48
2.1.7.3.3	Description of techniques, methods and equipment	48
2.1.8	Post processing operations (H).....	48
2.1.8.1	Packing and filling (H.1).....	48
2.1.8.1.1	Objective	48
2.1.8.1.2	Field of application.....	48
2.1.8.1.3	Description of techniques, methods and equipment	49
2.1.8.2	Gas flushing and storage under gas (H.2)	50
2.1.8.2.1	Objective	50
2.1.8.2.2	Field of application.....	51
2.1.8.2.3	Description of techniques, methods and equipment	51
2.1.9	Utility processes (U)	51
2.1.9.1	Cleaning and disinfection (U.1)	51
2.1.9.1.1	Objective	51
2.1.9.1.2	Field of application.....	51
2.1.9.1.3	Description of techniques, methods and equipment	52
2.1.9.2	Energy generation and consumption (U.2).....	52
2.1.9.2.1	Objective	52
2.1.9.2.2	Field of application.....	53
2.1.9.2.3	Description of techniques, methods and equipment	53
2.1.9.3	Water use (U.3)	53
2.1.9.3.1	Objective	53
2.1.9.3.2	Field of application.....	54
2.1.9.3.3	Process water.....	55
2.1.9.3.4	Cooling water	55
2.1.9.3.5	Boiler feed-water	56

2.1.9.4	Vacuum generation (U.4)	56
2.1.9.4.1	Objective	56
2.1.9.4.2	Field of application	56
2.1.9.4.3	Description of techniques, methods and equipment	56
2.1.9.5	Refrigeration (U.5)	57
2.1.9.5.1	Objective	57
2.1.9.5.2	Field of application	57
2.1.9.5.3	Description of techniques, methods and equipment	57
2.1.9.6	Compressed air generation (U.6)	58
2.1.9.6.1	Objective	58
2.1.9.6.2	Field of application	58
2.1.9.6.3	Description of techniques	58
2.2	The application of unit operations in the FDM sector	58
2.2.1	Meat and poultry	61
2.2.1.1	Canned meat (beef muscle in gelatine)	62
2.2.1.1.1	Thawing (A.5)	62
2.2.1.1.2	Cutting (B.1)	63
2.2.1.1.3	Mixing/blending (B.2)	63
2.2.1.1.4	Packing and filling (H.1)	63
2.2.1.1.5	Sterilisation (E.8)	63
2.2.1.1.6	Secondary packaging (H.1)	63
2.2.1.1.7	Refrigeration (U.5)	63
2.2.1.2	Cooked ham	63
2.2.1.2.1	Thawing (A.5)	64
2.2.1.2.2	Cutting (B1)	64
2.2.1.2.3	Pickling (D.7)	65
2.2.1.2.4	Homogenisation (B.2)	65
2.2.1.2.5	Cooking (E.3)	65
2.2.1.3	Cured ham	65
2.2.1.3.1	Brining/curing (D7)	66
2.2.1.3.2	Ageing (D.14)	67
2.2.1.3.3	Washing (A.4)	67
2.2.1.3.4	Coating (D.13)	67
2.2.1.3.5	Packing (H.1)	67
2.2.1.3.6	Gas flushing (H.2)	67
2.2.2	Fish and shellfish	67
2.2.2.1	Frozen processed fish/moulded fish products and fish fingers	68
2.2.2.2	Canned fish/shellfish products	68
2.2.2.3	Crustaceans	69
2.2.2.4	Molluscs	69
2.2.3	Fruit and vegetables	69
2.2.3.1	Ready meals that predominantly contain fruit and vegetables	70
2.2.3.2	Fruit juice	71
2.2.3.3	Heat treated fruit	71
2.2.3.4	Frozen fruit	72
2.2.3.5	Fruit preserves	72
2.2.3.6	Dried fruit	73
2.2.3.7	Tomatoes	73
2.2.3.8	Potatoes	73
2.2.3.8.1	Potato chips	74
2.2.3.8.2	Potato crisps	74
2.2.3.9	Vegetable juice	74
2.2.3.10	Heat treated and frozen vegetables	75
2.2.3.11	Pickling of vegetables	75
2.2.3.12	Vegetable drying	75
2.2.4	Vegetable oils and fats	75
2.2.4.1	Seed oil extraction	76
2.2.4.2	Refining of edible oils and fats	76
2.2.4.3	Crystallisation of edible oils and fats	78
2.2.4.4	Further processing of edible oils and fats – margarine	78
2.2.4.5	Olive oil	78
2.2.4.6	Olive-pomace oil	79
2.2.5	Dairy products	79

2.2.5.1	Milk and cream	79
2.2.5.2	Condensed and powdered milk	82
2.2.5.3	Butter.....	84
2.2.5.4	Cheese	85
2.2.5.5	Yoghurt	87
2.2.5.6	Ice-cream.....	88
2.2.5.7	Whey	89
2.2.6	Grain mill products	89
2.2.7	Dry pasta	90
2.2.8	Starch	91
2.2.8.1	Maize starch	92
2.2.8.2	Wheat starch.....	93
2.2.8.3	Potato starch.....	94
2.2.8.4	Sweeteners	96
2.2.8.5	Modified (physical/chemical) starch	96
2.2.9	Animal feed.....	96
2.2.9.1	Animal feed and dry petfood.....	96
2.2.9.2	Moist petfood	97
2.2.9.3	Semi-moist petfood	97
2.2.10	Bread.....	97
2.2.11	Confectionery.....	99
2.2.11.1	Biscuits.....	99
2.2.11.2	Cakes.....	99
2.2.11.3	Cocoa	100
2.2.11.4	Chocolate	100
2.2.11.5	Boiled sweets	101
2.2.12	Sugar	101
2.2.12.1	Sugar beet extraction.....	101
2.2.12.2	Sugar cane	102
2.2.12.3	Sugar refining.....	102
2.2.13	Coffee.....	102
2.2.13.1	Roasting coffee.....	102
2.2.13.2	Instant coffee.....	103
2.2.13.3	Decaffeinated coffee	104
2.2.14	Yeast	105
2.2.15	Malting.....	105
2.2.16	Brewing.....	106
2.2.16.1	Mashing.....	107
2.2.16.2	Fermentation	107
2.2.16.3	Maturation/conditioning.....	107
2.2.17	Distilling	108
2.2.17.1	Scotch whisky	108
2.2.17.2	Cognac	108
2.2.18	Wine.....	109
2.2.18.1	Reception	109
2.2.18.2	Grape crushing and destemming	109
2.2.18.3	Pressing	109
2.2.18.4	Fining	109
2.2.18.5	Fermentation	109
2.2.18.6	Ageing.....	109
2.2.18.7	Cold stabilisation.....	110
2.2.18.8	Bottling.....	110
2.2.19	Soft drinks.....	110
2.2.20	Citric acid.....	110
3	CURRENT CONSUMPTION AND EMISSION LEVELS	113
3.1	General consumption and emission information.....	115
3.1.1	Water.....	115
3.1.1.1	Water consumption	115
3.1.1.2	Waste water.....	116
3.1.1.2.1	Quantity of waste water.....	116
3.1.1.2.2	Composition of waste water	117
3.1.2	Air emissions	118

3.1.2.1	Odour	119
3.1.3	Loss of materials.....	119
3.1.3.1	Exceed weight/volume specification	119
3.1.3.2	Spillage	119
3.1.3.3	Leakage/overflow	119
3.1.3.4	Product defects/returned product	120
3.1.3.5	Inherent loss.....	120
3.1.3.6	Retained material	120
3.1.3.7	Heat deposited waste	120
3.1.4	Energy	120
3.2	Consumption and emissions in unit operations.....	121
3.2.1	Materials handling and storage (A.1)	123
3.2.1.1	Water	123
3.2.1.2	Air emissions	123
3.2.1.3	Solid output.....	124
3.2.1.4	Energy.....	124
3.2.1.5	Noise.....	124
3.2.1.6	Accidental release.....	124
3.2.2	Sorting/screening, grading, dehulling, destemming/destalking and trimming (A.2)	124
3.2.2.1	Water	124
3.2.2.2	Air emissions	124
3.2.2.3	Solid output.....	124
3.2.2.4	Energy.....	124
3.2.3	Peeling (A.3).....	125
3.2.3.1	Water	125
3.2.3.2	Air emissions	125
3.2.3.3	Solid output.....	125
3.2.3.4	Energy.....	125
3.2.3.5	Noise.....	125
3.2.4	Washing (A.4) and thawing (A.5)	125
3.2.4.1	Water	125
3.2.4.2	Solid output.....	125
3.2.4.3	Energy.....	126
3.2.5	Cutting, slicing, chopping, mincing, pulping and pressing (B.1)	126
3.2.5.1	Water	126
3.2.5.2	Solid output.....	126
3.2.5.3	Energy.....	126
3.2.5.4	Noise.....	126
3.2.6	Mixing/blending, homogenisation and conching (B.2)	126
3.2.6.1	Water	126
3.2.6.2	Air emissions	126
3.2.6.3	Solid output.....	126
3.2.6.4	Energy.....	127
3.2.6.5	Noise.....	127
3.2.7	Grinding/milling and crushing (B.3)	127
3.2.7.1	Water	127
3.2.7.2	Air emissions	127
3.2.7.3	Solid output.....	127
3.2.7.4	Energy.....	127
3.2.7.5	Noise.....	127
3.2.8	Forming/moulding and extruding (B.4).....	127
3.2.8.1	Water	127
3.2.8.2	Air emissions	127
3.2.8.3	Solid output.....	127
3.2.8.4	Energy.....	127
3.2.9	Extraction (C.1)	128
3.2.9.1	Water	128
3.2.9.2	Air emissions	128
3.2.9.3	Solid output.....	128
3.2.9.4	Energy.....	128
3.2.9.5	Noise.....	128
3.2.10	Deionisation (C.2)	128
3.2.10.1	Water	128

3.2.10.2	Solid output	129
3.2.11	Fining (C.3).....	129
3.2.11.1	Water.....	129
3.2.11.2	Solid output	129
3.2.12	Centrifugation and sedimentation (C.4).....	129
3.2.12.1	Water.....	129
3.2.12.2	Solid output	129
3.2.12.3	Energy	129
3.2.12.4	Noise	129
3.2.13	Filtration (C.5)	129
3.2.13.1	Water.....	129
3.2.13.2	Air emissions.....	129
3.2.13.3	Solid output	130
3.2.13.4	Energy	130
3.2.14	Membrane separation (C.6).....	130
3.2.14.1	Water.....	130
3.2.14.2	Energy	130
3.2.15	Crystallisation (C.7).....	130
3.2.15.1	Water.....	130
3.2.15.2	Solid output	130
3.2.15.3	Energy	130
3.2.16	Removal of free fatty acids by neutralisation (C.8)	130
3.2.16.1	Water.....	130
3.2.16.2	Air emissions.....	130
3.2.16.3	Solid output	131
3.2.16.4	Energy	131
3.2.17	Bleaching (C.9).....	131
3.2.17.1	Air emissions.....	131
3.2.17.2	Solid output	131
3.2.17.3	Energy	131
3.2.18	Deodorisation by steam stripping (C.10)	131
3.2.18.1	Water.....	131
3.2.18.2	Air emissions.....	131
3.2.18.3	Solid output	131
3.2.18.4	Energy	131
3.2.18.5	Noise	132
3.2.19	Decolourisation (C.11).....	132
3.2.19.1	Water.....	132
3.2.19.2	Solid output	132
3.2.19.3	Energy	132
3.2.20	Distillation (C.12)	132
3.2.20.1	Water.....	132
3.2.20.2	Air emissions.....	132
3.2.20.3	Solid output	132
3.2.20.4	Energy	132
3.2.20.5	Noise	133
3.2.21	Soaking (D.1).....	133
3.2.21.1	Water.....	133
3.2.21.2	Solid output	133
3.2.22	Dissolving (D.2).....	133
3.2.22.1	Water.....	133
3.2.22.2	Air emissions.....	133
3.2.22.3	Energy	133
3.2.23	Solubilisation/alkalising (D.3)	133
3.2.23.1	Water.....	133
3.2.23.2	Air emissions.....	133
3.2.23.3	Energy	133
3.2.24	Fermentation (D.4).....	134
3.2.24.1	Water.....	134
3.2.24.2	Air emissions.....	134
3.2.24.3	Solid output	134
3.2.24.4	Energy	134
3.2.25	Coagulation (D.5).....	134

3.2.25.1	Water	134
3.2.25.2	Energy.....	134
3.2.26	Germination (D.6)	134
3.2.26.1	Water	134
3.2.26.2	Air emissions	134
3.2.26.3	Energy.....	134
3.2.27	Brining/curing and pickling (D.7)	135
3.2.27.1	Water	135
3.2.28	Smoking (D.8)	135
3.2.28.1	Water	135
3.2.28.2	Air emissions	135
3.2.28.3	Solid output.....	135
3.2.28.4	Energy.....	135
3.2.29	Hardening (D.9).....	135
3.2.29.1	Water	135
3.2.29.2	Air emissions	135
3.2.29.3	Solid output.....	135
3.2.29.4	Energy.....	136
3.2.29.5	Noise.....	136
3.2.30	Sulphitation (D.10).....	136
3.2.30.1	Air emissions	136
3.2.31	Carbonatation (D.11).....	136
3.2.31.1	Air emissions	136
3.2.31.2	Solid output.....	136
3.2.31.3	Noise.....	136
3.2.32	Carbonation (D.12).....	136
3.2.32.1	Air emissions.....	136
3.2.32.2	Energy.....	136
3.2.33	Coating/spraying/enrobing/agglomeration/encapsulation (D.13).....	136
3.2.33.1	Water	136
3.2.33.2	Air emissions	137
3.2.33.3	Solid output.....	137
3.2.34	Ageing (D.14).....	137
3.2.34.1	Water	137
3.2.34.2	Air emissions	137
3.2.34.3	Solid output.....	137
3.2.35	Melting (E.1)	137
3.2.35.1	Water	137
3.2.35.2	Air emissions	137
3.2.35.3	Solid output.....	137
3.2.35.4	Energy.....	137
3.2.36	Blanching (E.2).....	137
3.2.36.1	Water	137
3.2.36.2	Air emissions	138
3.2.36.3	Solid output.....	138
3.2.36.4	Energy.....	138
3.2.37	Cooking and boiling (E.3)	138
3.2.37.1	Water	138
3.2.37.2	Air emissions	138
3.2.37.3	Solid output.....	138
3.2.37.4	Energy.....	138
3.2.38	Baking (E.4)	138
3.2.38.1	Water	138
3.2.38.2	Air emissions	138
3.2.38.3	Solid output.....	138
3.2.38.4	Energy.....	139
3.2.39	Roasting (E.5).....	139
3.2.39.1	Water	139
3.2.39.2	Air emissions	139
3.2.39.3	Solid output.....	139
3.2.39.4	Energy.....	139
3.2.40	Frying (E.6)	139
3.2.40.1	Water	139

3.2.40.2	Air emissions.....	139
3.2.40.3	Solid output	140
3.2.40.4	Energy	140
3.2.41	Tempering (E.7).....	140
3.2.41.1	Water.....	140
3.2.41.2	Energy	140
3.2.42	Pasteurisation, sterilisation and UHT (E.8).....	140
3.2.42.1	Water.....	140
3.2.42.2	Energy	140
3.2.43	Evaporation (liquid to liquid) (F.1).....	140
3.2.43.1	Water.....	140
3.2.43.2	Air emissions.....	140
3.2.43.3	Energy	141
3.2.43.4	Noise	141
3.2.44	Drying (liquid to solid) (F.2).....	141
3.2.44.1	Water.....	141
3.2.44.2	Air emissions.....	141
3.2.44.3	Solid output	141
3.2.44.4	Energy	141
3.2.44.5	Noise	141
3.2.45	Dehydration (solid to solid) (F.3).....	142
3.2.45.1	Water.....	142
3.2.45.2	Air emissions.....	142
3.2.45.3	Solid output	142
3.2.45.4	Energy	142
3.2.45.5	Noise	142
3.2.46	Cooling, chilling and cold stabilisation (G.1)	142
3.2.46.1	Water.....	142
3.2.46.2	Air emissions.....	142
3.2.46.3	Energy	142
3.2.46.4	Noise	143
3.2.47	Freezing (G.2).....	143
3.2.47.1	Water.....	143
3.2.47.2	Air emissions.....	143
3.2.47.3	Energy	143
3.2.47.4	Noise	143
3.2.48	Freeze-drying/lyophilisation (G.3).....	144
3.2.48.1	Water.....	144
3.2.48.2	Energy	144
3.2.49	Packing and filling (H.1).....	144
3.2.49.1	Water.....	144
3.2.49.2	Air emissions.....	144
3.2.49.3	Solid output	144
3.2.49.4	Energy	144
3.2.49.5	Noise	144
3.2.50	Gas flushing and storage under gas (H.2)	144
3.2.50.1	Air emissions.....	144
3.2.51	Cleaning and disinfection (U.1)	145
3.2.51.1	Water.....	145
3.2.51.2	Solid output	145
3.2.51.3	Energy	145
3.2.52	Energy generation and consumption (U.2)	145
3.2.52.1	Water.....	145
3.2.52.2	Air emissions.....	145
3.2.52.3	Solid output	146
3.2.52.4	Noise	146
3.2.53	Water use (U.3).....	146
3.2.53.1	Water.....	146
3.2.53.2	Solid output	146
3.2.54	Vacuum generation (U.4).....	146
3.2.54.1	Water.....	146
3.2.54.2	Air emissions.....	146
3.2.54.3	Energy	147

3.2.54.4	Noise.....	147
3.2.55	Refrigeration (U.5).....	147
3.2.55.1	Water.....	147
3.2.55.2	Air emissions.....	147
3.2.55.3	Energy.....	147
3.2.55.4	Noise.....	147
3.2.56	Compressed air generation (U.6).....	147
3.2.56.1	Air emissions.....	147
3.2.56.2	Energy.....	147
3.2.56.3	Noise.....	147
3.3	Consumption and emission levels in some individual FDM sectors.....	147
3.3.1	Meat and poultry.....	150
3.3.1.1	General information.....	150
3.3.1.1.1	Water.....	150
3.3.1.1.2	Air emissions.....	150
3.3.1.1.3	Solid output.....	150
3.3.1.1.4	Energy.....	150
3.3.1.2	Meat and poultry production.....	150
3.3.1.2.1	General information.....	150
3.3.1.2.2	Salami and sausage production.....	152
3.3.1.3	Meat and poultry preservation.....	153
3.3.1.3.1	Freezing.....	153
3.3.1.3.2	Curing.....	153
3.3.1.3.3	Smoking.....	154
3.3.1.3.4	Drying.....	155
3.3.1.3.5	Canning.....	155
3.3.2	Fish and shellfish.....	155
3.3.2.1	Water consumption.....	156
3.3.2.2	Waste water.....	156
3.3.2.3	Solid output.....	157
3.3.2.4	Energy.....	161
3.3.3	Fruit and vegetables.....	161
3.3.3.1	Water consumption.....	161
3.3.3.2	Waste water.....	164
3.3.3.3	Solid output.....	169
3.3.3.4	Energy.....	172
3.3.3.5	Data for some fruit and vegetable products.....	173
3.3.3.5.1	Fresh-pack.....	173
3.3.3.5.2	Preserved fruit and vegetables.....	173
3.3.3.5.3	Frozen vegetables.....	175
3.3.3.5.4	Juices.....	178
3.3.3.5.5	Other products.....	178
3.3.4	Vegetable oils and fats.....	178
3.3.4.1	Water consumption.....	178
3.3.4.1.1	Olive oil.....	178
3.3.4.2	Waste water.....	178
3.3.4.2.1	Olive oil.....	180
3.3.4.3	Air emissions.....	180
3.3.4.4	Solid output.....	181
3.3.4.4.1	Oilseed.....	183
3.3.4.4.2	Olive oil.....	184
3.3.4.5	Energy.....	184
3.3.4.6	Chemicals used.....	185
3.3.5	Dairy products.....	185
3.3.5.1	Water.....	185
3.3.5.1.1	Water consumption.....	185
3.3.5.1.2	Waste water.....	187
3.3.5.2	Air emissions.....	190
3.3.5.3	Solid output.....	190
3.3.5.4	Energy.....	193
3.3.5.5	Consumption of chemicals.....	194
3.3.5.6	Noise.....	195
3.3.6	Dry pasta.....	195

3.3.6.1	Water.....	195
3.3.6.2	Emissions to air.....	195
3.3.6.3	Energy.....	195
3.3.7	Starch.....	196
3.3.7.1	Water consumption.....	196
3.3.7.2	Waste water.....	196
3.3.7.3	Air emissions.....	196
3.3.7.4	Solid output.....	196
3.3.7.5	Energy.....	197
3.3.8	Sugar.....	197
3.3.8.1	Sugar beet.....	197
3.3.8.1.1	Water consumption.....	197
3.3.8.1.2	Waste water.....	198
3.3.8.1.3	Solid output.....	198
3.3.8.1.4	Energy.....	199
3.3.8.2	Cane sugar refining.....	200
3.3.9	Coffee.....	200
3.3.10	Drinks.....	200
3.3.10.1	Water consumption.....	200
3.3.10.2	Waste water.....	200
3.3.10.2.1	Wine.....	201
3.3.10.2.2	Cider and perry.....	201
3.3.11	Brewing.....	202
3.3.11.1	Water consumption.....	203
3.3.11.2	Waste water.....	203
3.3.11.3	Air emissions.....	205
3.3.11.4	Solid output.....	205
3.3.11.5	Energy.....	206
3.3.11.6	Noise.....	207
3.3.11.7	Solid output.....	207
3.3.12	Citric acid.....	207
3.3.12.1	Water consumption.....	207
3.3.12.2	Waste water.....	207
3.3.12.3	Solid output.....	207
4	TECHNIQUES TO CONSIDER IN THE DETERMINATION OF BAT.....	209
4.1	General techniques for the FDM sector.....	211
4.1.1	Environmental management tools.....	211
4.1.2	Optimise operation by providing training.....	217
4.1.3	Equipment design.....	218
4.1.3.1	Design equipment to minimise consumption and emission levels.....	218
4.1.3.2	Selection of efficient and quiet fans.....	219
4.1.3.3	Selection of fans with low numbers of blades.....	220
4.1.3.4	Designing pipework to minimise noise emissions.....	221
4.1.3.5	Sound insulation of equipment.....	222
4.1.3.6	Position equipment to direct noise away from neighbours.....	223
4.1.4	Installation design considerations.....	223
4.1.4.1	Sound insulation of buildings.....	224
4.1.4.2	Shielding buildings from noise immission sites.....	225
4.1.4.3	Application of a spiral turbulence generator to a chimney to minimise noise emissions.....	225
4.1.5	Maintenance.....	226
4.1.6	Methodology for preventing and minimising the consumption of water and energy and the production of waste.....	227
4.1.6.1	Step 1: Obtaining management commitment, organisation and planning.....	231
4.1.6.2	Step 2: Analysis of production processes.....	232
4.1.6.2.1	Analysis of production processes aimed at the prevention and minimisation of water consumption.....	233
4.1.6.2.2	Analysis of production processes aimed at the prevention and minimisation of energy consumption.....	234
4.1.6.2.3	Analysis of production processes aimed at the prevention and minimisation of waste production.....	235
4.1.6.3	Step 3: Assessment of objectives.....	238

4.1.6.4	Step 4: Identifying prevention and minimisation options	238
4.1.6.4.1	Pinch technology.....	239
4.1.6.5	Step 5: Carry out an evaluation and feasibility study	240
4.1.6.6	Step 6: Implementing the prevention and minimisation programme	241
4.1.6.7	Step 7: Ongoing monitoring by measurement and visual inspection.....	241
4.1.7	Production management techniques	243
4.1.7.1	Apply production planning, to minimise associated waste production and cleaning frequencies.....	243
4.1.7.2	Receive materials in bulk.....	244
4.1.7.3	Minimise storage times for perishable materials	244
4.1.7.4	Transport solid materials dry	246
4.1.7.5	Use a waste management team	247
4.1.7.6	Segregation of outputs, to optimise use, re-use, recovery, recycling and disposal (and minimise water use and waste water contamination).....	248
4.1.7.7	Use of by-products, co-products and residues as animal feed	250
4.1.7.8	Segregation of water streams to optimise re-use and treatment.....	253
4.1.7.9	Minimise heating and cooling times	254
4.1.7.10	Optimise start-up and shut-down procedures and other special operating situations	255
4.1.7.11	Good housekeeping	255
4.1.7.12	Manage on-site vehicle movements.....	255
4.1.8	Process control techniques.....	257
4.1.8.1	Control temperature, by dedicated measurement and correction.....	257
4.1.8.2	Control flow or level, by dedicated measurement of pressure.....	258
4.1.8.3	Level measurement	259
4.1.8.4	Flow measurement and control.....	260
4.1.8.5	Analytical measurement	262
4.1.8.5.1	pH measurement	262
4.1.8.5.2	Conductivity measurement	263
4.1.8.5.3	Turbidity measurement.....	265
4.1.8.6	Use automated water start/stop controls	267
4.1.8.7	Use of control devices	268
4.1.8.8	Use of water nozzles.....	269
4.1.9	Selection of materials	270
4.1.9.1	Selection of raw FDM materials which minimise solid waste and harmful emissions to air and water.....	270
4.1.9.2	Selection of auxiliary materials used	271
4.1.9.3	Avoiding the use of ozone depleting substances, such as halogenated refrigerants	271
4.2	Techniques applicable in a number of FDM sectors (reflects the structure of Chapters 2 and 3)	272
4.2.1	Materials reception, handling and storage	272
4.2.1.1	Switch off the engine and refrigerator unit of a vehicle during loading/unloading and when parked	272
4.2.2	Thawing.....	272
4.2.2.1	Thawing using recirculation and air stirring.....	272
4.2.2.2	Thawing in containers filled with warm water with air bubbles at the bottom.....	273
4.2.2.3	Thawing by sprinkling.....	273
4.2.2.4	Thawing by 100 % water saturated heated air	274
4.2.2.5	Thawing in air.....	274
4.2.3	Centrifugation/separation	275
4.2.3.1	Minimisation of centrifugal separator waste discharges	275
4.2.4	Fermentation.....	275
4.2.4.1	Carbon dioxide recovery and purification	275
4.2.5	Smoking.....	277
4.2.5.1	Smoke from burning wood	277
4.2.5.2	Smoke from smouldering wood.....	278
4.2.5.3	Liquid smoke	279
4.2.5.4	Friction smoke	279
4.2.5.5	Smoke from superheated steam	280
4.2.6	Cooking	280
4.2.6.1	Water bath oven – cooking water	280
4.2.6.2	Water bath oven – using water instead of brine.....	281

4.2.6.3	Shower oven.....	281
4.2.6.4	Steam oven.....	281
4.2.6.5	Hot air oven.....	282
4.2.6.6	Microwave oven.....	282
4.2.7	Frying.....	282
4.2.7.1	Recirculate and burn exhaust gases.....	282
4.2.8	Preservation in cans, bottles and jars.....	283
4.2.8.1	Avoiding cooking before preservation in cans, bottles and jars, if food can be cooked during sterilisation.....	283
4.2.8.2	Automated filling incorporating recycling of spillages.....	284
4.2.8.3	Recovery of floating oil when washing filled cans, bottles and jars.....	284
4.2.8.4	Batch sterilisation after filling of cans, bottles and jars.....	284
4.2.8.5	Continuous sterilisation after filling of cans, bottles and jars.....	285
4.2.9	Evaporation.....	286
4.2.9.1	Multistage evaporation.....	287
4.2.9.2	Vapour compression/recompression.....	288
4.2.9.2.1	Mechanical vapour recompression (MVR).....	289
4.2.9.2.2	Thermal vapour recompression (TVR).....	291
4.2.10	Cooling.....	292
4.2.10.1	Using a plate heat-exchanger for precooling ice-water with ammonia.....	292
4.2.10.2	Using cold water from a river or lake for precooling ice-water.....	293
4.2.10.3	Closed-circuit cooling.....	293
4.2.11	Freezing.....	295
4.2.11.1	Energy efficiency in deep freezing.....	295
4.2.11.2	Lowering condensation pressure.....	295
4.2.11.3	Lowering condensation temperature.....	295
4.2.11.4	Raising evaporation temperature.....	296
4.2.11.5	Using high efficiency motors for driving fans.....	297
4.2.11.6	Reducing the fan output during short production stops.....	298
4.2.11.7	Operating without automatic defrosting during short production stops.....	298
4.2.12	Packing and filling.....	299
4.2.12.1	Selection of packaging materials.....	299
4.2.12.2	Optimisation of packaging design – to reduce the quantity.....	300
4.2.12.3	Segregation of packaging materials to optimise use, re-use, recovery, recycling and disposal.....	301
4.2.12.4	Optimising packing line efficiency.....	302
4.2.12.5	Waste minimisation by optimising packing line speed.....	303
4.2.12.6	Use of in-line check-weighers to prevent overfilling of packaging.....	303
4.2.13	Energy generation and consumption.....	304
4.2.13.1	Combined heat and power generation (CHP) – European overview.....	304
4.2.13.1.1	Combined heat and power generation (CHP).....	304
4.2.13.2	Efficiency of a heat generator.....	308
4.2.13.2.1	Improving the efficiency of a heat generator.....	309
4.2.13.3	Insulation of pipes, vessels and equipment.....	310
4.2.13.4	Heat pumps for heat recovery.....	310
4.2.13.5	Heat recovery from cooling systems.....	311
4.2.13.6	Switch off equipment when it is not needed.....	312
4.2.13.7	Reduce the loads on motors.....	312
4.2.13.8	Minimise motor losses.....	313
4.2.13.9	Frequency converters on motors.....	313
4.2.13.10	Use variable speed drives to reduce the load on fans and pumps.....	314
4.2.14	Water use.....	315
4.2.14.1	Only pump up water that is required.....	315
4.2.15	Refrigeration and air conditioning.....	315
4.2.15.1	Optimising air conditioning and cold storage temperatures.....	315
4.2.15.2	Minimising transmission and ventilation losses from cooled rooms, coldstores and freezing tunnels.....	316
4.2.15.3	Regularly defrosting the entire system.....	317
4.2.15.4	Optimisation of the defrosting cycle.....	317
4.2.15.5	Automatic defrosting of cooling evaporators in cold storage.....	317
4.2.15.6	Use of binary ice as a cooling fluid (secondary refrigerant).....	318
4.2.16	Compressed air generation and use.....	320
4.2.16.1	Optimise pressure settings.....	320

4.2.16.2	Optimise the air inlet temperature.....	321
4.2.16.3	Fit silencers to air inlets and exhausts.....	321
4.2.17	Steam systems	322
4.2.17.1	Maximise condensate return.....	322
4.2.17.2	Avoid losses of flash steam from condensate return.....	322
4.2.17.3	Isolate unused/infrequently used pipework.....	323
4.2.17.4	Minimising the blowdown of a boiler.....	323
4.3	Cleaning.....	324
4.3.1	Dry cleaning of equipment and installations	324
4.3.1.1	Provision and use of catchpots over floor drains	325
4.3.2	Pre-soak floors and open equipment to loosen dirt before cleaning	326
4.3.3	Pigging.....	326
4.3.4	Removal of residual materials from pipework, using compressed air, before cleaning or product change-over	328
4.3.5	Management of water, energy and detergents used	329
4.3.6	Fit cleaning hoses with hand operated triggers.....	330
4.3.7	Pressure cleaning.....	330
4.3.7.1	Supply of pressure-controlled water and via nozzles.....	330
4.3.7.2	High pressure cleaning using a centralised water ring main	331
4.3.7.3	Low pressure foam cleaning.....	332
4.3.7.4	Cleaning with gels	333
4.3.8	Selection of cleaning agents	334
4.3.8.1	Selection of disinfectants and sterilants.....	334
4.3.8.2	Use of chelating agents.....	334
4.3.8.2.1	Using EDTA	335
4.3.8.2.2	Known risks associated with using EDTA.....	335
4.3.8.2.3	Not using EDTA	336
4.3.8.2.4	Reducing EDTA use by minimising milkstone formation by production planning	336
4.3.8.2.5	Example of a strategy to minimise the use of EDTA.....	337
4.3.9	CIP (cleaning-in-place) and its optimal use.....	338
4.3.10	Frequent and prompt cleaning of processing equipment and materials storage areas	341
4.3.11	Using metered water dispensers and/or high pressure low volume (HPLV) sprays for cleaning trucks.....	342
4.4	Techniques for minimising air emissions	342
4.4.1	Air emissions control strategy	342
4.4.1.1	Step 1: Definition of the problem	343
4.4.1.1.1	Odour example.....	344
4.4.1.2	Step 2: Inventory of site emissions	344
4.4.1.2.1	Odour example.....	345
4.4.1.3	Step 3: Measurement of major emissions	346
4.4.1.3.1	Odour example.....	346
4.4.1.4	Step 4: Selection of air emission control techniques	347
4.4.2	Process-integrated techniques.....	347
4.4.3	End-of-pipe air treatment.....	347
4.4.3.1	Optimal use of air abatement equipment	349
4.4.3.2	Collection of air emissions at source – local exhaust ventilation	349
4.4.3.3	Transport of ducted emissions to the treatment or abatement equipment.....	351
4.4.3.4	Selection of end-of-pipe odour/VOCs abatement techniques	352
4.4.3.5	Dynamic separation techniques	354
4.4.3.5.1	Separators	354
4.4.3.5.2	Cyclones	355
4.4.3.5.3	Wet separation	356
4.4.3.6	Electrostatic precipitators	359
4.4.3.7	Filters.....	360
4.4.3.7.1	Tubular filters	361
4.4.3.7.2	Bag filters.....	363
4.4.3.7.3	Packed bed filters.....	365
4.4.3.8	Absorption	366
4.4.3.8.1	Packed bed absorber	368
4.4.3.8.2	Plate absorber.....	369
4.4.3.8.3	Spray scrubber	371
4.4.3.9	Carbon adsorption.....	372

4.4.3.10	Biological treatment.....	374
4.4.3.10.1	Biofilter.....	375
4.4.3.10.2	Bioscrubber.....	378
4.4.3.11	Thermal treatment of waste gases.....	380
4.4.3.11.1	Thermal oxidation of waste gases.....	380
4.4.3.11.2	Oxidation of waste gases in an existing boiler.....	386
4.4.3.11.3	Catalytic oxidation of waste gases.....	387
4.4.3.12	Non-thermal plasma treatment.....	390
4.4.3.13	Physical dispersion of odour/VOC emissions.....	394
4.4.3.13.1	Extending the height of the discharge stack.....	395
4.4.3.13.2	Increasing stack discharge velocity.....	396
4.5	End-of-pipe waste water treatment.....	396
4.5.1	Discharge of waste water from installations.....	397
4.5.1.1	Waste water treatment techniques applied.....	398
4.5.2	Primary treatments.....	402
4.5.2.1	Screening (T1).....	402
4.5.2.2	Fat trap for the removal of FOG and light hydrocarbons (T2).....	403
4.5.2.3	Flow and load equalisation (T3).....	404
4.5.2.4	Neutralisation (T4) and self-neutralisation.....	405
4.5.2.5	Sedimentation (T5).....	406
4.5.2.6	Dissolved air flotation (DAF) (T6).....	407
4.5.2.7	Diversion (emergency) tank (T7).....	408
4.5.2.8	Centrifugation (T8).....	409
4.5.2.9	Precipitation (T9).....	409
4.5.3	Secondary treatments.....	411
4.5.3.1	Aerobic processes.....	412
4.5.3.1.1	Activated sludge (T10).....	413
4.5.3.1.2	Pure oxygen systems (T11).....	414
4.5.3.1.3	Sequencing batch reactors (SBR) (T12).....	415
4.5.3.1.4	Aerobic lagoons (T13).....	416
4.5.3.1.5	Trickling filters (T14).....	417
4.5.3.1.6	Bio-towers (T15).....	417
4.5.3.1.7	Rotating biological contactors (RBC) (T16).....	418
4.5.3.1.8	Biological aerated flooded filters (BAFF) and submerged biological aerated filters (SBAF) (T17).....	419
4.5.3.1.9	High rate and ultrahigh rate aerobic filters (T18).....	419
4.5.3.2	Anaerobic processes.....	420
4.5.3.2.1	Anaerobic lagoons (T19).....	422
4.5.3.2.2	Anaerobic contact processes (T20).....	422
4.5.3.2.3	Anaerobic filters (T21).....	422
4.5.3.2.4	Upflow anaerobic sludge blanket (UASB) (T22).....	423
4.5.3.2.5	Internal circulation (IC) reactors (T23).....	424
4.5.3.2.6	Hybrid USAB reactors (T24).....	424
4.5.3.2.7	Fluidised and expanded bed reactors (T25).....	424
4.5.3.2.8	Expanded granular sludge bed reactors (EGSB) (T26).....	425
4.5.3.3	Aerobic/anaerobic combined processes.....	426
4.5.3.3.1	Membrane bio-reactors (MBR) (T27).....	426
4.5.3.3.2	Multistage systems (T28).....	427
4.5.4	Tertiary treatments.....	428
4.5.4.1	Biological nitrification/denitrification (T29).....	428
4.5.4.2	Ammonia stripping (T30).....	429
4.5.4.3	Phosphorus removal by biological methods (T31).....	431
4.5.4.4	Dangerous and priority hazardous substances removal (T32).....	432
4.5.4.5	Filtration (T33).....	433
4.5.4.6	Membrane filtration (T34).....	433
4.5.4.7	Biological nitrifying filters (T35).....	435
4.5.4.8	Disinfection and sterilisation (T36).....	435
4.5.4.8.1	Biocides.....	435
4.5.4.8.2	UV radiation.....	436
4.5.5	Natural treatments.....	437
4.5.5.1	Integrated constructed wetlands (ICW) (T37).....	437
4.5.6	Sludge treatment.....	438
4.5.6.1	Waste water sludge treatment techniques.....	439

4.5.6.1.1	Sludge conditioning (T38)	439
4.5.6.1.2	Sludge stabilisation (T39)	439
4.5.6.1.3	Sludge thickening (T40)	440
4.5.6.1.4	Sludge dewatering (T41)	441
4.5.6.1.5	Sludge drying (T42)	442
4.5.7	Waste water treatment in the various sectors	442
4.5.7.1	Meat and poultry	442
4.5.7.1.1	Waste water treatment	442
4.5.7.2	Fish and shellfish	443
4.5.7.2.1	Waste water characteristics	443
4.5.7.2.2	Waste water treatment	444
4.5.7.3	Fruit and vegetables	444
4.5.7.3.1	Waste water characteristics	444
4.5.7.3.2	Waste water treatment	445
4.5.7.3.3	Water recovery in a vegetable processing company – a case study	447
4.5.7.3.4	Re-use of vegetable washing waste water after treatment – a case study	449
4.5.7.3.5	Re-use of water during pea processing, after chlorination	450
4.5.7.3.6	Potato processing	451
4.5.7.4	Vegetable oils and fats	451
4.5.7.4.1	Waste water treatment	451
4.5.7.4.2	Olive oil	452
4.5.7.4.3	Multistage waste water treatment for vegetable oil refining – a case study	453
4.5.7.5	Dairy products	455
4.5.7.5.1	Waste water characteristics	455
4.5.7.5.2	Waste water treatment	455
4.5.7.6	Starch	456
4.5.7.6.1	Waste water characteristics	456
4.5.7.6.2	Waste water treatment	456
4.5.7.6.3	Re-use of process water in potato starch manufacturing	457
4.5.7.7	Sugar	460
4.5.7.7.1	Waste water treatment	460
4.5.7.8	Drinks	463
4.5.7.8.1	Waste water characteristics	463
4.5.7.8.2	Waste water treatment	463
4.5.7.8.3	Brewing	464
4.5.7.8.4	Water re-cycling in a brewery	465
4.5.7.8.5	Distilling	467
4.5.7.8.6	Wine	468
4.5.7.9	Citric acid	469
4.6	Prevention of accidents	470
4.6.1	Identification of potential accidents	470
4.6.2	Risk assessment	472
4.6.3	Identify potential accidents which need to be controlled	474
4.6.4	Identify and implement control measures needed	474
4.6.5	Develop, implement and test an emergency plan	475
4.6.6	Investigate all accidents and near misses	477
4.7	Techniques applicable in some individual sectors	477
4.7.1	Meat and poultry	477
4.7.1.1	Segregation of outputs, to optimise use, re-use, recovery, recycling and disposal (and minimise water use and waste water contamination)	477
4.7.1.2	Dry cleaning	478
4.7.1.3	Minimise the production and use of flake ice	478
4.7.2	Fish and shellfish	478
4.7.2.1	Segregation of outputs, to optimise use, re-use, recovery, recycling and disposal (and minimise water use and waste water contamination)	478
4.7.2.2	Dry cleaning	479
4.7.2.3	Use only high quality fish	479
4.7.2.4	Transport of skin and fat from the skinner drum by vacuum	480
4.7.2.5	Removal and transport of fat and viscera by vacuum	480
4.7.2.6	Dry transport of fat, viscera, skin and fillets, incorporating mesh conveyors	481
4.7.2.7	Avoiding scaling if the fish is subsequently skinned	482
4.7.2.8	Using the filtered recirculated scaling waste water for preliminary fish rinsing	482
4.7.2.9	Case studies	483

4.7.2.9.1	Herring processing in Denmark.....	483
4.7.2.9.2	Fish processing in the UK	484
4.7.3	Fruit and vegetables	485
4.7.3.1	Segregation of outputs, to optimise use, re-use, recovery, recycling and disposal (and minimise water use and waste water contamination)	485
4.7.3.2	Dry cleaning.....	485
4.7.3.3	Protected outdoor storage of fruit and vegetables	485
4.7.3.4	Peeling of fruit and vegetables.....	486
4.7.3.4.1	Steam peeling – continuous process.....	486
4.7.3.4.2	Steam peeling – batch process.....	487
4.7.3.4.3	Abrasion peeling	488
4.7.3.4.4	Knife peeling.....	489
4.7.3.4.5	Wet caustic peeling	491
4.7.3.4.6	Dry caustic peeling.....	492
4.7.3.4.7	Flame peeling.....	493
4.7.3.5	Blanching of fruit and vegetables.....	493
4.7.3.5.1	Steam blanching with air cooling.....	494
4.7.3.5.2	Belt blanching with water cooling.....	494
4.7.3.5.3	Belt blanching with air cooling	495
4.7.3.5.4	Drum blancher with countercurrent water cooling.....	496
4.7.3.6	Cooling fruit and vegetables before freezing	497
4.7.3.7	Re-use of water in fruit and vegetable processing.....	499
4.7.4	Vegetable oils and fats	501
4.7.4.1	Two-phase extraction of olive oil.....	501
4.7.4.2	Countercurrent flow desolventiser-toaster (DT) in vegetable oil extraction	504
4.7.4.3	Re-use of the vapours from the DT in the miscella distillation in vegetable oil extraction.....	506
4.7.4.4	Re-use of heat in the hardening of vegetable oils.....	507
4.7.4.5	Mineral oil scrubber to recover hexane.....	508
4.7.4.6	Hexane recovery using a reboiler and gravity separator	509
4.7.4.7	Refining of vegetable oils	510
4.7.4.7.1	Chemical refining.....	510
4.7.4.7.2	Physical refining.....	512
4.7.4.8	Using citric acid instead of phosphoric acid for acid degumming	513
4.7.4.9	Enzymatic degumming.....	514
4.7.4.10	The use of cyclones to reduce wet dust emissions in vegetable oil extraction.....	516
4.7.4.11	Water ring pumps for generating an auxiliary vacuum of 40 to 120 mbar.....	517
4.7.4.12	Deodorisation.....	517
4.7.4.12.1	Double scrubber in combination with a once-through cooling system in vegetable oil deodorisation.....	518
4.7.4.12.2	Single scrubber in combination with an alkaline closed-circuit system in vegetable oil deodorisation.....	520
4.7.4.12.3	Single scrubber in combination with a dry condensing system in vegetable oil deodorisation	522
4.7.5	Dairy products.....	524
4.7.5.1	Segregation of outputs, to optimise use, re-use, recovery, recycling and disposal (and minimise water use and waste water contamination)	524
4.7.5.2	Dry cleaning.....	524
4.7.5.3	Partial homogenisation of market milk	525
4.7.5.4	Use of computer controlled milk transfer, pasteurisation, homogenisation and CIP equipment.....	525
4.7.5.5	Use of continuous pasteurisers.....	527
4.7.5.6	Regenerative heat-exchange in a pasteurisation process.....	527
4.7.5.7	Reduce cleaning requirements of centrifuges by improved preliminary milk filtration and clarification.....	528
4.7.5.8	Two-stage drying in milk powder production.....	529
4.7.5.9	Use of an aseptic packaging system not requiring an aseptic chamber	530
4.7.5.10	Online detection of transition points between the product and the water phases	532
4.7.5.11	Provision of in-line storage tanks to minimise product recirculation in pasteurisers	532
4.7.5.12	Just-in-time mixing “component filling”.....	533
4.7.5.13	Butter.....	534
4.7.5.13.1	Minimisation of losses during buttermaking.....	534

4.7.5.14	Cheese.....	534
4.7.5.14.1	Using ultrafiltration (UF) for protein standardisation of cheese milk.....	534
4.7.5.14.2	Reduction of fat and cheese fines in whey.....	535
4.7.5.14.3	Minimise the production of acid whey and its discharge to the WWTP.....	536
4.7.5.14.4	Recovery and use of whey.....	536
4.7.5.14.5	Recovery of salt whey by evaporation.....	537
4.7.5.14.6	Recovery of whey by removal of salt using RO.....	537
4.7.5.14.7	Utilisation of heat from warm whey for preheating cheese milk.....	537
4.7.5.14.8	High temperature cheese ripening with later humidification and ionisation of the ventilation air.....	538
4.7.5.15	Ice-cream.....	539
4.7.5.15.1	Heat recovery from pasteurisation in ice-cream production.....	539
4.7.5.16	Re-use and recycling of water for cleaning in dairies.....	540
4.7.5.17	Re-using warm cooling water for cleaning.....	541
4.7.5.18	In-process environmental management at a dairy – a case study.....	542
4.7.6	Starch.....	543
4.7.6.1	Countercurrent water use/re-use in starch washing.....	543
4.7.7	Sugar.....	544
4.7.7.1	Drying of sugar beet pulp.....	544
4.7.7.1.1	Low temperature drying of sugar beet pulp.....	544
4.7.7.1.2	High temperature drying of sugar beet pulp.....	545
4.7.7.1.3	Two-stage drying of sugar beet pulp.....	547
4.7.7.1.4	Steam drying of sugar beet pulp.....	547
4.7.7.1.5	Comparison of steam, HTD and two-stage drying of beet pulp.....	548
4.7.7.2	Reducing sugar beet soil tare.....	556
4.7.7.3	Sugar beet water/waste water re-use.....	557
4.7.8	Coffee.....	558
4.7.8.1	Waste heat re-use in instant coffee manufacturing.....	558
4.7.8.2	Abatement of air emissions from agglomeration during instant coffee manufacturing.....	558
4.7.8.3	Biofilter – used in coffee processing.....	559
4.7.8.4	Coffee roasting.....	559
4.7.8.4.1	Recirculation of air during coffee roasting.....	561
4.7.8.4.2	Water mist cooling of roasted coffee.....	562
4.7.8.4.3	Coffee roasting followed by catalytic oxidation of the waste gases.....	563
4.7.8.4.4	Biofilter – used in coffee processing.....	565
4.7.9	Drinks.....	566
4.7.9.1	Segregation of outputs, to optimise use, re-use, recovery, recycling and disposal (and minimise water use and waste water contamination).....	566
4.7.9.2	Dry cleaning.....	566
4.7.9.3	Recovery of yeast after fermentation.....	566
4.7.9.4	Filtration.....	567
4.7.9.4.1	Filtration of the product using membrane separation.....	567
4.7.9.4.2	Cross-flow filtration.....	568
4.7.9.4.3	Recovery of filter material when the product is filtered using natural mineral adsorbents.....	569
4.7.9.5	Bottling.....	569
4.7.9.5.1	Integrated bottling installation.....	569
4.7.9.5.2	Multistage bottle cleaning system.....	573
4.7.9.5.3	Re-use of bottle cleaning solutions after sedimentation and filtration.....	576
4.7.9.5.4	Optimisation of water consumption in bottle cleaning.....	577
4.7.9.5.5	Re-use of bottle pasteurising water.....	577
4.7.9.6	Brewing.....	578
4.7.9.6.1	Mashing.....	580
4.7.9.6.2	Mash infusion process.....	580
4.7.9.6.3	Mash decoction process.....	581
4.7.9.6.4	Re-use of hot water from wort cooling.....	581
4.7.9.6.5	Heat recovery from wort boiling.....	582
4.7.9.6.6	Process optimisation in a small brewery – a case study.....	583
4.7.9.7	Distilling.....	584
4.7.9.7.1	Recovery of distiller’s dried grains with solubles (DDGS).....	584
4.7.9.7.2	Concentration of mash from molasses distilling.....	585
4.7.9.8	Wine.....	586

4.7.9.8.1	Re-use of cleaning solution from the cold stabilisation tanks	586
4.7.9.8.2	Gradual discharge of cleaning solution from the cold stabilisation tanks to the WWTP.....	586
5	BEST AVAILABLE TECHNIQUES	589
5.1	General BAT for the whole FDM sector.....	592
5.1.1	Environmental management.....	594
5.1.2	Collaboration with upstream and downstream activities.....	595
5.1.3	Equipment and installation cleaning	595
5.1.4	Additional BAT for some processes and unit operations applied in a number of FDM sectors	596
5.1.4.1	Materials reception/despatch.....	596
5.1.4.2	Centrifugation/separation.....	596
5.1.4.3	Smoking	596
5.1.4.4	Frying.....	596
5.1.4.5	Preservation in cans, bottles and jars.....	596
5.1.4.6	Evaporation.....	596
5.1.4.7	Freezing and refrigeration.....	597
5.1.4.8	Cooling.....	597
5.1.4.9	Packing.....	597
5.1.4.10	Energy generation and use	598
5.1.4.11	Water use.....	598
5.1.4.12	Compressed air systems	598
5.1.4.13	Steam systems.....	598
5.1.5	Minimisation of air emissions.....	598
5.1.6	Waste water treatment.....	599
5.1.7	Accidental releases.....	601
5.2	Additional BAT for some individual FDM sectors.....	601
5.2.1	Additional BAT for the meat and poultry sector.....	601
5.2.2	Additional BAT for the fish and shellfish sector	601
5.2.3	Additional BAT for the fruit and vegetables sector	602
5.2.4	Additional BAT for the vegetable oils and fats sector	603
5.2.5	Additional BAT for dairies	603
5.2.5.1	Additional BAT for the production of market milk	604
5.2.5.2	Additional BAT for milk powder production.....	604
5.2.5.3	Additional BAT for buttermaking.....	605
5.2.5.4	Additional BAT for cheesemaking.....	605
5.2.5.5	Additional BAT for ice-cream manufacturing	605
5.2.6	Additional BAT for starch manufacturing	605
5.2.7	Additional BAT for the sugar sector.....	606
5.2.8	Additional BAT for the coffee sector.....	606
5.2.9	Additional BAT for drinks manufacturing.....	606
5.2.9.1	Additional BAT for brewing	607
5.2.9.2	Additional BAT for winemaking	607
6	EMERGING TECHNIQUES	609
6.1	Use of UV/ozone in absorption for odour abatement.....	609
7	CONCLUDING REMARKS	611
7.1	Timing of the work.....	611
7.2	Level of consensus, driving forces and issues arising from the final TWG meeting	611
7.3	Information provided	612
7.4	Information imbalances and gaps.....	614
7.5	Recommendations for future work.....	615
7.6	Suggested topics for future R&D projects	617
8	REFERENCES	619
	GLOSSARY	629

List of figures

Figure 2.1: Flow diagram of continuous neutralisation of oils and fats.....	23
Figure 2.2: An example of the steeping procedure.....	26
Figure 2.3: Canned meat production.....	62
Figure 2.4: Cooked ham and shoulder production.....	64
Figure 2.5: Cured ham production.....	66
Figure 2.6: The process for deep frozen fruit.....	72
Figure 2.7: Manufacture of various tomato products.....	73
Figure 2.8: Crude oil chemical refining.....	77
Figure 2.9: Short time pasteurised milk process.....	80
Figure 2.10: Production of UHT milk.....	81
Figure 2.11: Production of sterilised milk.....	82
Figure 2.12: Flow sheet of processes for condensed products (e.g. UHT condensed milk) and intermediate products (e.g. milk concentrates).....	83
Figure 2.13: Flow sheet of powdered milk production.....	84
Figure 2.14: Continuous buttermaking.....	85
Figure 2.15: Manufacture of cheese.....	86
Figure 2.16: Yoghurt production.....	88
Figure 2.17: Summary of the dry pasta production process.....	91
Figure 2.18: An example maize starch production process.....	93
Figure 2.19: An example wheat starch production process.....	94
Figure 2.20: An example potato starch production process.....	95
Figure 2.21: Instant coffee manufacturing.....	103
Figure 2.22: Citric acid fermentation process.....	111
Figure 3.1: Output stream terminology used in the FDM sector.....	113
Figure 3.2: Water consumption by the German FDM industries in 1998.....	116
Figure 3.3: Consumption and emission levels of the process steps in fish canning.....	158
Figure 3.4: Consumption and emission levels of the process steps in filleting and preserving fish.....	159
Figure 3.5: Consumption and emission levels of the process steps in crustaceans processing.....	160
Figure 3.6: Consumption and emission levels of the process steps in mollusc processing.....	161
Figure 3.7: Waste water produced in fruit and vegetable processing.....	168
Figure 3.8: Type and amount of wastes produced in fruit and vegetable processing and preservation.....	170
Figure 3.9: Type and amount of wastes produced in fruit and vegetable juice manufacturing.....	171
Figure 3.10: Types and quantities of wastes and by-products generated in vegetable oil processing.....	183
Figure 3.11: Water consumption/processed milk ratio as a function of the quantity of processed milk.....	186
Figure 3.12: Typical losses of milk in the dairy industry.....	189
Figure 3.13: Type and amount of wastes produced in milk processing.....	191
Figure 3.14: Type and amount of wastes produced in yoghurt processing.....	192
Figure 3.15: Type and amount of wastes produced in cheese processing.....	192
Figure 3.16: Type and amount of waste water, wastes and by-products from sugar beet processing.....	199
Figure 3.17: Input and output figures for large German breweries (capacity over 1 million hl beer) per hl of beer sold.....	202
Figure 3.18: Co-product, by-product and solid waste quantities from a 1 million hl beer/yr brewery.....	205
Figure 4.1: The effect of the number of fan blades on the distance of noise transmission.....	220
Figure 4.2: Reduction in noise emissions from a chimney.....	225
Figure 4.3: Reduction in energy consumption.....	229
Figure 4.4: Example of a waste prevention and minimisation methodology.....	231
Figure 4.5: Example work sheet to identify input/output and environmental issues.....	232
Figure 4.6: Overview of the water input and output of an example installation.....	233
Figure 4.7: Detailed process flow diagram for liquid milk production.....	237
Figure 4.8: Waste reduction in petfood production.....	248
Figure 4.9: Whey recovery using turbidity measurement.....	266
Figure 4.10: Process flow diagram of a CO ₂ conditioning system in a large brewery.....	276
Figure 4.11: Heat and oil recovery: heat-exchangers mounted in the fryer exhaust hood.....	283
Figure 4.12: The principle of falling film evaporation.....	286
Figure 4.13: Milk evaporation using a falling film.....	287
Figure 4.14: MVR evaporator principle.....	289
Figure 4.15: Flowchart of a 4 stage MVR milk evaporator system.....	290
Figure 4.16: Comparison of the operating costs of TVR and MVR evaporators.....	291
Figure 4.17: Optimising the freezing tunnels in the production of deep frozen vegetables.....	296

Figure 4.18: Comparison of energy efficiencies between a conventionally operated gas turbine generator and CHP	306
Figure 4.19: Flow sheet of a CHP system in a brewery	307
Figure 4.20: Binary ice system with a conventional refrigeration plant.....	318
Figure 4.21: Flow sheet of a cleaning-in-place system	339
Figure 4.22: Flowchart for the selection of odour abatement techniques.....	343
Figure 4.23: Flow sheet for the selection of odour abatement equipment (**see Table 4.32).....	353
Figure 4.24: Operational principle of a cyclone.....	355
Figure 4.25: Typical arrangement of an electrostatic precipitator (only two zones shown).....	360
Figure 4.26: Types and classification of filters	360
Figure 4.27: Tubular filter system of a large dairy.....	362
Figure 4.28: Picture of an industrial baghouse.....	364
Figure 4.29: Packed bed reactor layout.....	368
Figure 4.30: Plate absorber layout.....	370
Figure 4.31: Spray chamber layout	371
Figure 4.32: Biofilter layout.....	375
Figure 4.33: Bioscrubber layout.....	379
Figure 4.34: Thermal oxidiser layout.....	381
Figure 4.35: Flow diagram showing the origin and process management of the flue-gas from the waste gas cleaning system of a smokehouse	384
Figure 4.36: Mass balance of a waste gas treatment system with direct flame thermal oxidation	385
Figure 4.37: Catalytic incineration layout.....	388
Figure 4.38: Industrial non-thermal plasma treatment equipment.....	391
Figure 4.39: MBR system simplified process flow diagram	427
Figure 4.40: The ammonia stripping process	430
Figure 4.41: Flow sheet of the treatment used for meat and poultry processing of waste water.....	443
Figure 4.42: Flow sheet of typical waste water treatment in the fruit and vegetable sector.....	446
Figure 4.43: WWTP at a vegetable processing installation for water re-use	449
Figure 4.44: Re-use of water in the canning industry.....	450
Figure 4.45: Typical waste water treatment applicable to a dairy.....	456
Figure 4.46: Water circuit in a potato starch installation	458
Figure 4.47: Typical options for treating sugar beet waste water.....	462
Figure 4.48: Anaerobic/aerobic waste water treatment system at a distillery	468
Figure 4.49: Equipment used for the dry removal of viscera	481
Figure 4.50: Steam peeling process in an example installation in Finland.....	487
Figure 4.51: Flow diagram of potato and carrot processing in a Finnish installation	490
Figure 4.52: Installation of a water cooler in the ice-water trough.....	498
Figure 4.53: Installation of an evaporator plate under the ice-water trough.....	498
Figure 4.54: The two-phase and three-phase olive oil extraction processes	502
Figure 4.55: Basic flow diagram of a countercurrent flow DT	505
Figure 4.56: Basic flow diagram of the vapour heat integration in the DT.....	506
Figure 4.57: Mineral oil system and related process steps.....	508
Figure 4.58: Process flow diagram for hexane recovery from process water in the extraction of unrefined vegetable oils.....	509
Figure 4.59: Basic flow diagram for the chemical refining of vegetable oils	510
Figure 4.60: Basic flow diagram for the acid degumming of vegetable oil	513
Figure 4.61: Basic flow diagram of wet dust emission separation by cyclones	516
Figure 4.62: Basic flow diagram of the double scrubber arrangement in deodorisation.....	519
Figure 4.63: Basic flow diagram of an alkaline closed-circuit cooling water system as a part of a deodoriser vacuum system	521
Figure 4.64: Basic flow diagram of a single scrubber in combination with a DC system.....	522
Figure 4.65: Processing flow sheet for a dairy producing milk.....	526
Figure 4.66: A two-stage drying process in a large dairy.....	529
Figure 4.67: Aseptic packaging of UHT milk, without an aseptic chamber	531
Figure 4.68: Flow diagram of the membrane processing system.....	541
Figure 4.69: Schematic diagram of steam drying with FBDs used for drying sugar beet cosettes.....	549
Figure 4.70: CHP and steam system of a sugar installation where cosettes are steam dried	550
Figure 4.71: HTD of sugar beet pulp	551
Figure 4.72: Two-stage drying of sugar beet pulp.....	552
Figure 4.73: Reduction of soil tare in Sweden	556
Figure 4.74: Batch roaster used by a German coffee company.....	560
Figure 4.75: Continuous coffee roasting process used by a German company.....	561
Figure 4.76: The principle of cross-flow filtration, compared to dead-end filtration.....	568

Figure 4.77: Flow diagram of the processing of spirits	570
Figure 4.78: Flow diagram of the bottling line	570
Figure 4.79: Bottle cleaning and rinsing steps	574
Figure 4.80: A bottle cleaning process with pH control to reduce water consumption	574
Figure 4.81: Use of a CIP system for the bottling process in a brewery	576
Figure 4.82: Heat recovery from a steam-heated wort kettle to produce hot water	582
Figure 4.83: Heat recovery from wort heating for preheating the wort before boiling	583
Figure 5.1: How the BAT conclusions are presented for FDM installations	591

List of tables

Table 1.1: Structure/production by countries (1998).....	1
Table 1.2: Structure/production by sector in EU-15.....	1
Table 1.3: EU-15 production in the major sectors (1999).....	2
Table 1.4: Top export destinations of EU-15 FDM products in 2001 (EUR million).....	3
Table 1.5: Exports from EU-15, by sectors in 2000.....	4
Table 1.6: Environmental issues for some FDM sectors.....	7
Table 2.1: The processing techniques and unit operations most commonly used in the FDM sector.....	10
Table 2.2: Examples of heat treatment combinations used in the FDM sector.....	40
Table 2.3: Typical total solids concentrations for various types of evaporators.....	41
Table 2.4: Typical freezing points of various FDM products.....	46
Table 2.5: Typical gas mix composition for gas flushing.....	51
Table 2.6: Unit operations applied in different sectors.....	60
Table 2.7: Summary of the possible processing routes of some fruit and vegetables.....	70
Table 2.8: Solvent decaffeination process.....	104
Table 2.9: Water decaffeination process.....	105
Table 3.1: Quantitative benchmarking parameters applicable in the FDM sector.....	114
Table 3.2: Percentage of raw materials which end up in the final product in some processes.....	115
Table 3.3: BOD ₅ equivalent of general FDM constituents and some products.....	117
Table 3.4: Environmental impacts of the FDM unit operations.....	122
Table 3.5: Codes used for emissions to air.....	123
Table 3.6: Codes used for emissions to water.....	123
Table 3.7: Codes used for solid outputs.....	123
Table 3.8: Typical energy requirement per tonne of cocoa.....	133
Table 3.9: Summary of water consumption and waste water volumes in the FDM sector.....	149
Table 3.10: By-products in cutting and deboning meat.....	150
Table 3.11: Consumption and emission levels for cooked ham manufacturing in Italy.....	151
Table 3.12: Specific consumption of water and energy and emissions of waste water in salami and sausage production.....	152
Table 3.13: Consumption and emission levels for preserved meat products manufacturing in Italy.....	153
Table 3.14: Consumption and emission levels for cured ham manufacturing in Italy.....	154
Table 3.15: Consumption and emission levels for canned meat in Italy.....	155
Table 3.16: Specific water consumption and organic load in Nordic countries.....	156
Table 3.17: Waste water from fish filleting.....	157
Table 3.18: Typical waste water production rates and characteristics for fish processing in Germany.....	157
Table 3.19: Water consumption levels achieved in fruit and vegetable installations.....	162
Table 3.20: Water consumption for some processes in the fruit and vegetable sector.....	162
Table 3.21: Consumption and emission levels for canning tomatoes.....	163
Table 3.22: Consumption and emission levels for manufacturing of tomato juice, puree and paste.....	164
Table 3.23: Average waste water and water pollution generated in the US canning industry in 1975.....	164
Table 3.24: BOD and TSS concentrations in waste water from fruit and vegetable processing.....	165
Table 3.25: Waste water characteristics from some fruit and vegetable processing.....	165
Table 3.26: Waste water volume and water pollution per unit of product generated in the processing of some vegetables.....	166
Table 3.27: Waste water volume and water pollution per unit of product generated in the processing of some fruit.....	167
Table 3.28: Solid waste produced during fruit and vegetable processing.....	169
Table 3.29: Fruit and vegetable wastes in juice manufacturing in Hungary.....	171
Table 3.30: Waste water values of brine during the production of Sauerkraut.....	175
Table 3.31: Electricity consumption during the sorting of vegetables.....	175
Table 3.32: Energy carrier and consumption for the caustic peeling of vegetables.....	176
Table 3.33: Energy carrier and consumption for the steam peeling of vegetables.....	176
Table 3.34: Electricity consumption for the washing of vegetables.....	176
Table 3.35: Electricity consumption of mechanical processing of vegetables before freezing.....	176
Table 3.36: Energy source and consumption for drum blanching in the deep freezing of vegetables.....	177
Table 3.37: Energy source and consumption for countercurrent water cooling of vegetables processing.....	177
Table 3.38: Energy carrier and consumption for a belt blancher with water cooling in vegetable processing.....	177
Table 3.39: Energy carrier and order of magnitude indicators of a belt blancher with air cooling in vegetable processing.....	177
Table 3.40: Waste water production in vegetable oil manufacturing steps.....	179

Table 3.41: Waste water characteristics in vegetable oil processing	179
Table 3.42: Reported untreated waste water characteristics in vegetable oil refining (cornflower, cottonseed and sunflower)	180
Table 3.43: Characteristics of olive oil mill waste water	180
Table 3.44: Hexane emission to air	180
Table 3.45: Summary of air emissions in the manufacturing of crude vegetable oils	181
Table 3.46: Summary of key solid/liquid emissions and by-products in the manufacturing of crude vegetable oils	182
Table 3.47: Summary of solid output from manufacturing crude vegetable oils	182
Table 3.48: Energy consumption in crude vegetable oil refining	184
Table 3.49: Water consumption in European dairies	186
Table 3.50: Water consumption for some Nordic dairies	186
Table 3.51: Approximate volumes of waste water in dairy activities	187
Table 3.52: Reported untreated dairy waste water contamination levels	188
Table 3.53: Volume and pollution levels of dairy waste water in Europe	188
Table 3.54: Typical BOD levels of various milk products	188
Table 3.55: Composition of cheese manufacturing waste water	190
Table 3.56: Product losses in some processes in the dairy industry	191
Table 3.57: Solid output per tonne of processed milk	191
Table 3.58: Production and disposal of solid wastes from some Nordic dairies	193
Table 3.59: Energy consumption in European dairies	193
Table 3.60: Total energy consumption for some Nordic dairies	194
Table 3.61: Consumption of cleaning agents used in European dairies	194
Table 3.62: Consumption of cleaning chemicals used in some Nordic dairies	194
Table 3.63: Air emissions from pasta manufacturing	195
Table 3.64: Energy consumption in the Italian pasta industry	196
Table 3.65: Water consumption in the starch industry	196
Table 3.66: Solid outputs from the starch industry	197
Table 3.67: Energy consumption in the starch industry	197
Table 3.68: Water consumption in Danish sugar factories	198
Table 3.69: Energy consumption in Danish sugar factories	200
Table 3.70: Average specific waste water discharges	200
Table 3.71: Waste water characteristics in processes of a red winery	201
Table 3.72: Water consumption for different brewery processes	203
Table 3.73: Waste water production in different brewery processes	203
Table 3.74: Untreated waste water characteristics for breweries	204
Table 3.75: Waste water and pollution generated in breweries	204
Table 3.76: Energy consumption of German breweries with more than 20 employees	206
Table 3.77: Heat consumption for different brewery processes	206
Table 3.78: Solid wastes and by-products in the citric acid fermentation process	207
Table 4.1: Format of information about techniques for consideration in the determination of BAT	209
Table 4.2: A guide to the noise reduction expected from reducing fan speeds	220
Table 4.3: Example worksheet for the breakdown of the energy consumption	235
Table 4.4: Examples of causes of material losses and some methods of maintaining an accurate inventory	236
Table 4.5: Key areas of waste milk generation	237
Table 4.6: Typical achievable reductions in water use	238
Table 4.7: Costs and savings reported in an example edible oil refinery when applying pinch technology	240
Table 4.8: Examples of sources of animal feed from FDM processes manufacturing for human consumption	252
Table 4.9: Noise measurements (mean of three independent measurements) from a German brewery	256
Table 4.10: Calculated partial rating levels for materials transport and transhipment processes	256
Table 4.11: Examples of use of level sensors in FDM processing	260
Table 4.12: Examples of the use of flow control in the FDM sector	261
Table 4.13: Typical applications of flow measurements in the FDM sector	262
Table 4.14: Examples of the use of pH measurement in the FDM sector	263
Table 4.15: Typical applications of pH measurement in the FDM sector	263
Table 4.16: Examples of the use of conductivity measurement in the FDM sector	265
Table 4.17: Typical applications of conductivity measurement in the FDM sector	265
Table 4.18: Examples of the use of turbidity measurement in the FDM sector	267
Table 4.19: Environmental impact of the different methods for smoke generation	277
Table 4.20: Comparison of efficiencies of multi-effect evaporators in the dairy industry	288

Table 4.21: Optimal values for the fume analysis in a pasta installation	309
Table 4.22: Comparison between the volumes of binary ice and brine required to achieve a 3 °C decrease in temperature.....	319
Table 4.23: Cooling requirements of a binary ice plant	320
Table 4.24: Potential savings by reducing boiler blowdown in the deep freezing of vegetables	324
Table 4.25: Environmental benefits and associated cost reduction using pigging systems.....	328
Table 4.26: Data sheet for collecting information on malodorous emissions	345
Table 4.27: Checklist for abnormal operation.....	345
Table 4.28: A typical odour measurement programme, using simplified measurements from an unspecified food manufacturing site	346
Table 4.29: End-of-pipe air treatment techniques	347
Table 4.30: Key parameters for the end-of-pipe selection procedure.....	348
Table 4.31: Comparisons of some separation techniques.....	348
Table 4.32: Summary of generalised criteria for selecting odour/VOC abatement techniques.....	352
Table 4.33: Dust removal from air – overview of wet separators	358
Table 4.34: Comparison between different bag filter systems	363
Table 4.35: Typical absorber design guidelines	367
Table 4.36: Properties of activated carbon	372
Table 4.37: Principle of operation of the main types of adsorbers.....	373
Table 4.38: Advantages and disadvantages of biological treatment.....	375
Table 4.39: Conditions at different stages of thermal oxidation	381
Table 4.40: Technical data of a direct flame thermal oxidiser applied in a smokehouse	383
Table 4.41: Technical data for a direct flame thermal oxidiser applied in a smokehouse.....	385
Table 4.42: Odour reduction using non-thermal plasma treatment	392
Table 4.43: Volumes treated at some installations that apply non-thermal plasma to reduce odour emissions	392
Table 4.44: Some waste water treatment techniques.....	399
Table 4.45: The typical application of some waste water treatment techniques in the FDM sector	400
Table 4.46: Typical FDM waste water quality after treatment.....	400
Table 4.47: A summary of waste water treatment processes used in different sectors.....	401
Table 4.48: Estimated pollution load reduction in the fish sector, when using rotary wedge wire screens	403
Table 4.49: Typical performance data of the brewery sector after sedimentation.....	406
Table 4.50: Advantages and disadvantages of sedimentation	406
Table 4.51: Removal efficiency of DAF in a herring filleting installation.....	408
Table 4.52: Removal efficiency of centrifugation in the herring industry	409
Table 4.53: Phosphorus removal performance data of an activated sludge and simultaneous precipitation WWTPs in the potato starch sector	410
Table 4.54: Advantages and disadvantages of anaerobic waste water treatment compared to aerobic treatment.....	412
Table 4.55: Advantages and disadvantages of aerobic treatment processes.....	412
Table 4.56: Performance data of an activated sludge WWTP reported for the brewing sector.....	413
Table 4.57: Characterisation of a typical SBR	415
Table 4.58: Typical process and performance data of anaerobic waste water treatment processes	421
Table 4.59: Common operational problems experienced with biological treatment processes.....	421
Table 4.60: Reported performance of a UASB reactor in the brewing sector	423
Table 4.61: Reported performance of an EGSB reactor in the brewing sector	425
Table 4.62: Design parameters for ammonia stripping of sugar industrial waste water (condensate)	430
Table 4.63: Phosphorus removal efficiencies of various waste water treatment methods	431
Table 4.64: Performance levels reported for an ICW.....	438
Table 4.65: Characteristics of untreated fish industry waste water and primary treatment efficiencies... ..	444
Table 4.66: Some waste water treatment combinations reported for the fruit and vegetable sector	447
Table 4.67: Water quality parameters of treated waste water, raw water and process water	448
Table 4.68: Quality of groundwater source for a vegetable processing installation compared to WHO guidelines	449
Table 4.69: Comparison of treatment alternatives for olive oil waste water	452
Table 4.70: Waste water characteristics before and after treatment.....	453
Table 4.71: Energy consumption data	453
Table 4.72: Description of waste water treatment system at an oil and fat processing facility	454
Table 4.73: Summary of applicability data	454
Table 4.74: Characteristics of starch sector waste water after treatment.....	457
Table 4.75: Concentration of potato starch process water by evaporation – design data.....	459
Table 4.76: Biological waste water treatment characteristics in a potato starch installation.....	459

Table 4.77: Performance of waste water treatment in a sugar industry of the Nordic countries.....	462
Table 4.78: Waste water production and main characteristics in Danish sugar installations.....	463
Table 4.79: Waste water loads after biological treatment during a sugar beet processing campaign	463
Table 4.80: Waste water characteristics in a brewery.....	466
Table 4.81: Summary of the pollution reduction results treating lauter tun waste water.....	466
Table 4.82: Treated waste water emission levels per tonne of installed production capacity in citric acid fermentation.....	469
Table 4.83: Discharge data before and after introduction of dry removal and transport of viscera.....	482
Table 4.84: Techniques applied in the herring filleting industry to reduce water consumption and waste water pollution.....	483
Table 4.85: Energy carrier and consumption for steam peeling, prior to freezing vegetables.....	486
Table 4.86: The effect of a combination of abrasion pre-peeling and knife peeling on water pollution loads in the production of half pears in syrup.....	490
Table 4.87: The effect of caustic peeling on water pollution in the production of half pears in syrup.....	491
Table 4.88: Energy carriers and consumption for caustic peeling, prior to freezing vegetables.....	491
Table 4.89: Comparison of the energy and water consumption levels within the different blanching techniques.....	493
Table 4.90: Energy carriers and consumption for a belt blancher with water cooling.....	495
Table 4.91: Energy carriers and consumption for a belt blancher with air cooling.....	496
Table 4.92: Energy carriers and order of magnitude indicators of the drum blancher.....	497
Table 4.93: Energy carriers and consumption for countercurrent drum water cooling.....	497
Table 4.94: Examples of water re-use in the fruit and vegetable sector.....	500
Table 4.95: Comparison of throughputs for the three-phase and two-phase olive oil processes.....	503
Table 4.96: Advantages and disadvantages of two-phase separation compared to the three-phase system in olive oil production.....	504
Table 4.97: Energy consumption data for the DT and downstream drying operation in oilseed extraction	505
Table 4.98: Consumption and emission levels for the chemical refining of vegetable oils.....	511
Table 4.99: Consumption figures for conventional and enzymatic degumming of vegetable oil.....	515
Table 4.100: Costs of conventional and enzymatic degumming of vegetable oil.....	515
Table 4.101: Comparison of cooling systems for vacuum generation in vegetable oil deodorisation.....	518
Table 4.102: Energy data of a double scrubber combined with a once-through cooling system.....	520
Table 4.103: Energy data of an alkaline closed-circuit system.....	521
Table 4.104: Performance data of an example DC system.....	523
Table 4.105: Savings in water and energy consumption in a dairy using UF for protein standardisation.....	535
Table 4.106: Composition of cheese manufacturing waste water.....	536
Table 4.107: Water re-use opportunities at dairies.....	540
Table 4.108: Characteristic LTD and HTD of sugar beet pulp.....	545
Table 4.109: Standardised framework data of the three example German installations.....	552
Table 4.110: Comparison of energy balances of three different options for beet pulp drying and for an installation without drying in Germany.....	553
Table 4.111: Comparison of the energy costs of different ways of drying beet pulp.....	554
Table 4.112: Comparison of expenditures expressed as NPV.....	555
Table 4.113: Mass concentration of dust after the cyclone.....	561
Table 4.114: Composition of the cooling waste gases from air cooling, before treatment.....	562
Table 4.115: Comparison of consumption and emission levels of different coffee roasting processes.....	564
Table 4.116: Consumption and emission figures of the bottling line (2000).....	572
Table 4.117: Production, energy consumption and waste water generation figures for a spirits installation from 1999 to 2001.....	572
Table 4.118: Average energy consumption figures comparing the old and new technology.....	573
Table 4.119: Water and waste water saving opportunities in a brewery.....	579
Table 4.120: Typical achievable reductions in water consumption in breweries.....	580
Table 4.121: Energy consumption in the brewhouse of a large brewery with a mash infusion process.....	580
Table 4.122: Consumption data for the drying of DDGS.....	584
Table 4.123: Consumption and emission data for the slops evaporation unit of a German molasses distillery.....	585
Table 5.1: Typical FDM waste water quality after treatment.....	600
Table 5.2: Consumption and emission levels associated with the production of market milk from 1 litre of received milk.....	604
Table 5.3: Consumption and emission levels associated with the production of milk powder from 1 litre of received milk.....	604
Table 5.4: Consumption and emission levels associated with the production of 1 kg of ice cream.....	605

SCOPE

This document reflects an exchange of information about the activities listed in Annex 1 parts 6.4. (b) and (c) of Council Directive 96/61/EC of 24 September 1996 on integrated pollution prevention and control (IPPC Directive), i.e.

6.4. (b) *Treatment and processing intended for the production of food products from:*

- *animal raw materials (other than milk) with a finished product production capacity greater than 75 tonnes per day*
- *vegetable raw materials with a finished product production capacity greater than 300 tonnes per day (average value on a quarterly basis)*

(c) *Treatment and processing of milk, the quantity of milk received being greater than 200 tonnes per day (average value on an annual basis)*

The scope includes the whole range of activities that may be found in European installations with capacities exceeding the above threshold values.

The document does not cover small scale activities, such as catering or activities in restaurants. Also, food industrial activities that do not use animal or vegetable raw materials are not covered, except as associated activities, e.g. mineral water processing and production of salt.

Agriculture, hunting and the slaughtering of animals are excluded. The manufacture of products other than food, e.g. soap, candles, cosmetics, pharmaceuticals; manufacture of gelatine and glue from hides, skin and bones are also excluded.

Another BREF in the series, i.e. the “Slaughterhouses and animal by-products BREF” [181, EC, 2003] covers the slaughtering of animals. The “slaughter” activity is considered to end with the making of standard cuts for large animals and the production of a clean whole saleable carcass for poultry. The scope of that BREF also includes some animal by-products processes which may produce food products, i.e. fat melting; fish-meal and fish oil production; blood processing and gelatine manufacturing.

Generally, packaging is not included but the packing of FDM products on the premises is included.

Animal feed of animal and vegetable origin are also within the scope of this document.

Information submitted about national legislation and standards is not included in this document. It is available in a separate document, which can be downloaded from the Activities page on the EIPPCB website, under Additional Information, (see <http://eippcb.jrc.es>).

1 GENERAL INFORMATION

1.1 Description, turnover, growth, employment

The FDM sector produces both finished products destined for consumption and intermediate products destined for further processing. A sectoral breakdown in EU-15 shows that for most FDM product categories production exceeds consumption. The FDM sector in EU-15 had a reported total production value amounting to EUR 593000 million in 2000.

Average real annual growth rates of consumption and production are slow, which is a typical trend for mature markets. For example, growth during 1997 was less than 2 %. In employment terms, the EU-15 FDM sector employs a workforce of 2.7 million. This represents 11 % of the industrial workforce.

Data from some European countries are presented in Table 1.1 and in Table 1.2.

1998	Turnover (EUR million)	Number of employees	Number of companies	Exports (EUR million)	Imports (EUR million)
Austria	8000	60579	1386	–	–
Belgium	22700	86797	6776	10700	9420
United Kingdom	100500	490000	2412	14000	26100
Czech Republic	–	142000	947	1000	1520
Denmark	14000	81115	312	–	–
The Netherlands	34000	108000	887	–	–
Estonia	610	21125	138	228	400
Finland	8160	49000	713	840	1240
France	122400	403000	4250	18000	8300
Germany	116600	545000	6134	19070	23060
Greece	5000	49000	524	–	–
Hungary	8240	131000	4215	1846	774
Ireland	14000	47000	694	–	–
Italy	–	350000	30000	10300	7200
Poland	19650	–	–	1180	1270
Portugal	10000	107000	2098	–	–
Spain	52590	398000	3200	4530	4700
Sweden	13510	60841	830	2110	4500
Total	549960	3129457	65516	83804	88484

Table 1.1: Structure/production by countries (1998)
[1, CIAA, 2002]

2000	Production		Added value		Employees	
	EUR million	%	EUR million	%	x10 ³	%
Processed meat	113000	19.1	21000	15.8	588	22.1
Fish products	14000	2.4	3000	2.3	91	3.4
Processed fruit and vegetables	36000	6.1	8000	6.0	174	6.5
Vegetable oils and fats	23000	3.9	2000	1.5	38	1.4
Dairy products	95000	16.0	14000	10.5	271	10.2
Flour and starch products	21000	3.5	4000	3.0	61	2.3
Animal feed	37000	6.2	6000	4.5	90	3.4
Drinks	98000	16.5	28000	21.1	316	11.9
Other FDM products	156000	26.3	47000	35.3	1037	38.8
Total	593000	100	133000	100	2666	100

Table 1.2: Structure/production by sector in EU-15
[1, CIAA, 2002]

More detailed figures for the total quantities and values of production in the major sectors of the EU-15 FDM sector, according to Eurostat (1999), are summarised in Table 1.3.

NACE Code ¹	Code description	All countries in 1999	
		Total quantity ('000 tonnes)	Total value (EUR million)
15.11	Fresh and preserved meat, except poultry	26026	40653
15.12	Fresh and preserved poultry meat	6759	11690
15.13	Meat and poultry meat products	11445	34236
15.20	Processed and preserved fish and fish products	4908	12494
15.31	Potatoes, processed and preserved	4054	4246
15.32	Fruit and vegetable juices	7644	5445
15.33	Processed and preserved fruit and vegetables n.e.c.	15485	16151
15.40	Animal and vegetable oils and fats	14922	4362
15.42	Refined oils and fats	7466	5445
15.43	Margarine and similar edible fats	2041	3524
15.51	Dairy products	74477	65267
15.52	Ice-cream and other edible ice	1928	3956
15.61	Grain mill products	42587	15431
15.62	Starches and starch products	11058	3764
15.71	Prepared animal feeds for farm animals ²	215045	50091
15.72	Prepared petfood	5115	4505
15.81	Bread, fresh pastry goods and cakes	10620	21360
15.82	Rusks and biscuits; preserved pastry goods and cakes	3466	12377
15.83	Sugar	16700	8924
15.84	Cocoa, chocolate and sugar confectionery	5857	22105
15.85	Pasta, e.g. macaroni, noodles, couscous and similar farinaceous products	4930	4934
15.86	Coffee and tea	2102	9747
15.87	Condiments and seasonings	2917	5024
15.88	Homogenised food preparations and dietetic food	624	2616
15.89	Other food products n.e.c.	3784	8416
15.91	Distilled potable alcoholic drinks	1087	5831
15.92	Ethyl alcohol from fermented materials	1367	773
15.93	Wines	13184	20169
15.94	Other fermented drinks, e.g. cider, perry and mead, and mixed drinks containing alcohol	379	408
15.95	Vermouth and other flavoured wine of fresh grapes	330	449
15.96	Beer made from malt	28030	17256
15.97	Malt	4516	1154
15.98	Mineral waters and soft drinks	64407	26661
	Total value	615260	449464

¹The NACE code is a classification of economic activities in the European Union based on an interpretation of the International Standard Industrial Classification (ISIC) [229, EC, 1990].

²These figures include both the production by the feed industry (125 million tonnes) and the production by home-mixers. This explains why the turnover mentioned for the feed industry in Table 1.2 is EUR 37000 million and not EUR 50000 million.

Table 1.3: EU-15 production in the major sectors (1999)
[1, CIAA, 2002]

1.2 Sector structure

Available statistics show that the EU-15 FDM sector comprises close to 26000 companies, most of which have over 20 employees.

The EU-15 FDM sector is exceptionally diverse compared to many other industrial sectors. This diversity can be seen in terms of the size and nature of companies; the wide range of raw materials, products and processes and the numerous combinations of each, and the production of homogenised global products as well as numerous specialist or traditional products on national and even regional scales. The sector is also subject to very diverse local economic, social and environmental conditions, and varying national legislation.

The EU-15 FDM industry is quite fragmented. Approximately 92 % of the sector is made up of SMEs, although there are some sectors, such as sugar manufacturing, which have very large installations. This fragmentation and diversity, as well as divergent data collection systems in individual MSs, makes it difficult to ascertain exact figures for the sector as a whole.

The sector is spread all over Europe, in very industrialised regions as well as in rural areas. Traditionally, industrial production has been closely related to primary production, climate, and natural resources, e.g. land and water, along with the actual requirements of the particular production technique. These heavily influence the structure and geographical location of specific industrial production. Although this kind of dependence is being reduced, it still holds true in many sectors. For example, some sectors are still concentrated in special regions, e.g. fish processing is usually found in countries, or regions which have direct access to the sea and traditions of fishing, and olive oil is mainly manufactured in Mediterranean countries, especially in Andalusia in Spain. Other activities such as sugar production/refining, grain milling and dairy industries are found in all countries. Some FDM production activities have special requirements of the natural resources, such as the need for receiving waters for the discharge of large volumes of treated waste water. Sugar installations, refineries and fruit and vegetable preservation installations are normally situated near to water, for this reason.

1.3 Trade

For many companies, exporting their product out of Europe is an important part of their business. In 2001, the EU-15 FDM sector exports amounted to EUR 45000 million, which represented 79 % of European global exports of agricultural and FDM products. This is a slight decrease over 1998 figures.

The main export market for European FDM products is the US. The Japanese, Swiss and Russian markets are also significant. The top export destinations of EU-15 FDM products in 2001, in financial terms, are shown in Table 1.4.

Export destination	EUR million
United States	9085
Japan	3716
Switzerland	2617
Russia	2569
Canada	1361
Poland	1157
Norway	1030
Australia	776
Czech Republic	767
South Korea	741
Algeria	721
Israel	528
Turkey	425
Total	25493

Table 1.4: Top export destinations of EU-15 FDM products in 2001 (EUR million)
[3, CIAA, 2001]

The top individual export sectors in the FDM sector in 2000, are shown in Table 1.5.

Sector	%
Processed meat	11.5
Fish products	2.2
Fruit and vegetables	6.1
Vegetable oils and fats	6.0
Dairy products	12.3
Flour and starch products	4.9
Animal feed	4.8
Confectionery	9.1
Sugars	3.9
Drinks	30.3
Total	91.1

Table 1.5: Exports from EU-15, by sectors in 2000
[1, CIAA, 2002]

1.4 Market forces: demand, distribution and competition

1.4.1 Demand

An ever increasing number of social and economic factors affect FDM consumption patterns throughout the EU-15. These have led to some diversification from traditional consumption and purchasing models. In recent years, European consumers have developed greater homogeneity in lifestyles and this is reflected in the consumption and purchasing patterns for a growing variety of goods. Nevertheless, FDM products still retain elements of cultural specificity linked to national or regional traditions. So although consumers want to be able to purchase the same items and quality of products throughout the whole of the EU-15, they also demand the option/choice of different products linked to their own tradition or culture. This can be reflected at a national, regional or even more local level and can also vary throughout the year.

1.4.2 Distribution

Cost control activities, e.g. labour saving technologies, improvements in logistics and distribution channels and resource saving practices, have been introduced. In general, most FDM products tend to be distributed to the major retail chains, although substantial differences persist between countries.

1.4.3 Competition

As is the case with most mature markets, the FDM sector is facing sharp competitive pressure and progressive market concentration. In fact, even if great fragmentation still persists in most countries, the size and corresponding economic strength of companies is becoming crucial for balancing the increasing bargaining power of retailers and achieving the minimum “critical mass” in terms of production volumes.

1.5 The importance of food safety in FDM processing

As well as environmental considerations, there are other legal requirements and prohibitions which must be considered when identifying “best available techniques” in the FDM industry. There are specific requirements relating to, e.g. food safety, and these are updated from time to time. All FDM production installations, regardless of their size, geographical location or point in the production process, must comply with the required food safety standards.

The achievement of the required standards can be made easier if all of the operators with responsibilities collaborate closely. The FDM industry has identified five key areas that can ensure day-to-day food safety, i.e. improved food safety systems, traceability, crisis management, risk identification and communication. The application of such principles can also be considered with respect to environmental protection. Where quality management systems developed from, e.g. ISO 9001 *Quality System – Model for quality assurance in design/development, production, installation and servicing*, and ISO 9002 *Quality System – Model for quality assurance in production, installation and servicing*, exist, the familiarity with such systems may facilitate the use of equivalent environmental standards-related systems.

The food safety laws may have an influence on environmental considerations. For example, food safety and hygiene requirements may affect the requirement for water use to clean the equipment and the installation, making it necessary to use hot water, so there are also energy considerations. Likewise, waste water is contaminated by substances used for hygiene purposes, for cleaning and sterilisation, e.g. during the production and packaging of long-life FDM products. These issues have to be considered to ensure that hygiene standards are maintained, but taking into account the control of water, energy, and detergent and sterilant use.

Care has been taken to ensure that nothing in this document conflicts with relevant food safety legislation.

1.6 Legislative framework for food, drink and milk products

Protection of the consumer and of the environment, and the elimination of obstacles to the free movement of goods are among the main concerns of EU-15 FDM legislation. The EU-15 legislative framework is based on horizontal measures across product categories as well as on commodity-specific so-called vertical measures, derived from the agricultural policy or the agri-monetary system.

As well as the general legislation, e.g. financial, environmental, health and safety, the FDM sector is also controlled by specific very detailed and comprehensive legislation starting at the farm gate and ending on the dinner plate. This legislation covers the following main areas:

- food and feed safety (contaminants, pesticide residues, quality of water intended for food consumption, official control of foodstuffs, materials in contact with foodstuffs)
- food and feed hygiene (general rules, health rules concerning foodstuffs of animal origin)
- food and feed composition (additives, flavourings, processing aids, GMOs)
- consumer information (general labelling rules, quantitative ingredient declaration, lot identification, unit pricing)
- food and feed nutrition, food and feed labelling
- ionisation
- organic production.

Section 1.7 refers to some selected legislation on the environment. Other pieces of environmental legislation are also valid for the industry, e.g. 98/83/EC Directive on the quality of water for human consumption.

1.7 The FDM sector and the environment

The FDM sector often depends on the quality of natural resources, especially that of land and water, so preserving the environment in which the raw materials are grown is very important.

The level of pollution in waste water and the amount of waste produced by the industry can represent a significant load in some countries or regions. While most emissions from the industry are biodegradable, some sectors use materials such as salt or brine which are resistant to conventional treatment methods and can introduce, e.g. pesticide residues used on the source crop.

Traditionally, in many European countries, the sector has not been heavily regulated by environmental legislation. The impetus for the sector to improve its environmental performance has therefore been based on efficiency improvements, e.g. maximising the utilisation of materials, which subsequently leads to a minimisation of waste.

There is now a trend towards focusing on proactive environmental management systems, natural resource conservation and the performance of waste minimisation techniques. To ensure sustainability, the effects of the raw material supply, food processing, transport, distribution, preparation, and disposal must be considered and controlled. Both primary production and processing are critically dependent upon a reliable water supply and adequate water quality, in conformity with legal requirements.

It is a challenge for the FDM sector to comply with the requirements of the Packaging Directive 94/62/EC by preventing the production of packaging waste, by re-use and recycling, as well as recovering packaging waste. Packaging is essential for preservation and for protection against handling, spoilage and contamination during production, distribution and sale. It is also a marketing and sales tool and it conveys information like ingredients, nutrient content, cooking instructions and storage information.

The efficient management of packaging and the minimisation of packaging waste is the responsibility of the FDM sector as well as farmers, retailers and consumers. In this context, the CEN standards on packaging, e.g. EN 13427:2000 [195, CEN, 2000], EN 13428:2000 [196, CEN, 2000] and EN 13431:2000 [197, CEN, 2000], are very useful. These standards provide guidelines to operators to enable them to comply with the essential requirements laid down by the Packaging Directive 94/62/EC. They offer the required flexibility to encourage innovation and enable packaging to be adapted to consumer needs. They can also be incorporated into the environmental and quality management systems within companies.

EMSs involve developing policies and guidelines, establishing objectives and programmes, allocating environmental responsibilities within an organisational structure, training and communication activities, operational control and conducting surveys and audits.

Many FDM companies have implemented an EMS and some are certified or in the process of being certified to ISO 14001 or the EU-15 Eco-Management and Audit Scheme (EMAS). In 2003, the FDM sector had the highest number of EMAS registered organisations in any sector and represented 9% of all EMAS registered organisations (for further information see Section 4.1.1).

1.7.1 Key environmental issues

Water consumption is one of the key environmental issues for the FDM sector. Most of the water which is not used as an ingredient, ultimately appears in the waste water stream. Typically, untreated FDM waste water is high in both COD and BOD. Levels can be 10 - 100 times higher than in domestic waste water. The SS concentration varies from negligible to as high as 120000 mg/l. Untreated waste water from some sectors, e.g. meat, fish, dairy and vegetable oil production, contains high concentrations of FOG.

The main air pollutants from FDM processes are dust, VOCs and odour. Refrigerants containing ammonia and halogen may be accidentally released. Odour is a local problem either related to the process or to the storage of raw materials, by-products or waste.

Noise may also be a problem for some installations, typically associated with vehicle movements and refrigeration.

The solid output from FDM installations is composed of by-products, co-products and waste. The main sources of solid output are spillage, leakage, overflow, defects/returned products, inherent loss, retained material that cannot freely drain to the next stage in the process and heat deposited waste.

The FDM sector is dependent on energy for processes required for freshness and food safety. Mechanical processing, e.g. raw material preparation and sizing, and thermal processing, e.g. dehydration, are the most commonly used techniques for food preservation and processing. Both require significant amounts of energy. Process heating uses approximately 29 % of the total energy used in the FDM sector. Process cooling and refrigeration accounts for about 16 % of the total energy used.

Table 1.6 shows the key environmental issues for some FDM sectors.

	Water use	Waste water	Chemicals use	Air pollution	Noise	Odour	Solid output	Energy use	
								Heating	Cooling and refrigeration
Meat and poultry	yes	yes		yes		yes	yes	yes	yes
Fish and shellfish	yes	yes			yes	yes	yes	yes	yes
Fruit and vegetables	yes	yes					yes	yes	yes
Vegetable oils and fats	yes	yes	yes	yes		yes	yes	yes	yes
Dairy products		yes	yes	yes	yes	yes	yes	yes	yes
Dry pasta	yes			yes				yes	
Starch	yes	yes		yes			yes	yes	
Sugar	yes	yes					yes	yes	
Drinks	yes	yes					yes	yes	yes
Breweries	yes	yes		yes	yes	yes	yes	yes	yes
Citric acid fermentation	yes	yes					yes	yes	

This table shows the key environmental issues for each sector and does not represent comparative quantitative data

Table 1.6: Environmental issues for some FDM sectors

2 APPLIED PROCESSES AND TECHNIQUES

Manufacturing in the FDM sector is diverse, using numerous individual processes. There are huge variations even in the production of similar products. All processes used in the sector cannot be described in detail in this document, but it covers a very wide range from the whole sector. Section 2.1 provides a short description of the processing techniques and unit operations used in the FDM sector, including their objectives and field of application. The application of processing techniques and unit operations in some FDM sectors is described in Section 2.2. The main environmental issues are listed, together with consumption and emission data, in Chapter 3.

2.1 Processing techniques and unit operations

The most commonly used processing techniques and unit operations in the FDM sector are shown in Table 2.1.

A. Materials reception and preparation	
A.1	Materials handling and storage
A.2	Sorting/screening, grading, dehulling, destemming/destalking and trimming
A.3	Peeling
A.4	Washing
A.5	Thawing
B. Size reduction, mixing and forming	
B.1	Cutting, slicing, chopping, mincing, pulping and pressing
B.2	Mixing/blending, homogenisation and conching
B.3	Grinding/milling and crushing
B.4	Forming/moulding and extruding
C. Separation techniques	
C.1	Extraction
C.2	Deionisation
C.3	Fining
C.4	Centrifugation and sedimentation
C.5	Filtration
C.6	Membrane separation
C.7	Crystallisation
C.8	Removal of free fatty acids by neutralisation
C.9	Bleaching
C.10	Deodorisation by steam stripping
C.11	Decolourisation
C.12	Distillation
D. Product processing technology	
D.1	Soaking
D.2	Dissolving
D.3	Solubilisation/alkalising
D.4	Fermentation
D.5	Coagulation
D.6	Germination
D.7	Brining/curing and pickling
D.8	Smoking
D.9	Hardening
D.10	Sulphitation
D.11	Carbonatation
D.12	Carbonation
D.13	Coating/spraying/enrobing/agglomeration/encapsulation
D.14	Ageing

E. Heat processing	
E.1	Melting
E.2	Blanching
E.3	Cooking and boiling
E.4	Baking
E.5	Roasting
E.6	Frying
E.7	Tempering
E.8	Pasteurisation, sterilisation and UHT
F. Concentration by heat	
F.1	Evaporation (liquid to liquid)
F.2	Drying (liquid to solid)
F.3	Dehydration (solid to solid)
G. Processing by removal of heat	
G.1	Cooling, chilling and cold stabilisation
G.2	Freezing
G.3	Freeze-drying/lyophilisation
H. Post processing operations	
H.1	Packing and filling
H.2	Gas flushing and storage under gas
U. Utility processes	
U.1	Cleaning and disinfection
U.2	Energy generation and consumption
U.3	Water use
U.4	Vacuum generation
U.5	Refrigeration
U.6	Compressed air generation

Table 2.1: The processing techniques and unit operations most commonly used in the FDM sector [1, CIAA, 2002]

The raw materials used by the FDM sector are natural products, which may vary from season to season and from year to year. It may, therefore, be necessary to adapt production processes to accommodate the changes in characteristics of the raw materials.

To process a raw material into a product normally involves applying a range of processing techniques linked together into a production line.

2.1.1 Materials reception and preparation (A)

2.1.1.1 Materials handling and storage (A.1)

2.1.1.1.1 Objective

Materials handling applies to the receipt, unpacking, storage and internal conveying of raw materials, intermediate products, final products and other outputs, including waste.

2.1.1.1.2 Field of application

Applied in all FDM premises.

2.1.1.1.3 Description of techniques, methods and equipment

Solid materials are commonly delivered in bags stacked on pallets or in containers. They may also be delivered frozen, packed in standardised blocks with carton linings. They are typically transported by forklift trucks and stored in warehouses. Larger amounts of solid raw materials and powders are mostly delivered in bulk. These are off-loaded directly for processing or stored in silos for future use. Solid raw materials can be conveyed by water, e.g. as is often the case for vegetables, roots and tubers, by air, e.g. as is the case for solid particles and powder, or by conveyor belts, elevators, screw conveyors and pumps.

Liquid materials are usually delivered in bulk tankers and then pumped into storage tanks. The internal transport of liquid is achieved by pumping the liquid through pipework systems, which can be extensive and complex. Smaller quantities of liquids are also delivered in mini-bulk containers or in drums. These are then transported to storage areas by forklift trucks.

Gases like N₂, CO₂ and SO₂ are delivered and stored in special pressurised containers. When they are required they are connected to the system concerned and transported through the pipework system by pressure differences. For example, SO₂ is used in the processing of sugar and wine, and N₂ and CO₂ in packing and chilling.

2.1.1.2 Sorting/screening, grading, dehulling, destemming/destalking and trimming (A.2)

2.1.1.2.1 Objective

Most raw materials contain some components which are inedible or have variable physical characteristics. Processing techniques such as sorting or screening, grading, dehulling, destemming or destalking and trimming are necessary to obtain the required uniformity of the raw material for further processing. A metal detector may also be used to ensure any metal particles in the raw material are removed.

2.1.1.2.2 Field of application

These processing techniques are used as a first step in the processing of fruit and vegetables. They are also used for meat, egg and fish processing.

2.1.1.2.3 Description of techniques, methods and equipment

Dry and wet **sorting or screening** is the separation of raw materials and/or slurries into categories on the basis of shape, size, weight, image and colour. Dry sorting is applied in the malting industry to select even sized grains. Wet sorting is used for slurries, to separate components.

Size sorting and dry cleaning of agricultural raw materials separates solids into two or more fractions. Size sorting is especially important for FDM products which have to be heated or cooled, as large differences in size can lead to an over or under-processing of the product. For size sorting, various types of screens and sieves, with fixed or variable apertures, can be used. The screens may be stationary, rotating or vibrating. Shape sorting can be carried out manually or mechanically with, e.g. a belt- or roller-sorter. Weight sorting is a very accurate method and is, therefore, used for more valuable foods, e.g. for cut meats, eggs, tropical fruits and certain vegetables. Image processing is used to sort foods on the basis of length, diameter and appearance, i.e. surface defects and orientation of food on a conveyor. Finally, colour sorting of defective discoloured items, can be applied at high rates using microprocessor controlled colour sorters.

Sorting also allows the separation of some additional undesirable material at first sight, e.g. leaves and stones, or inappropriate raw material such as immature or rotten berries, and is aimed at ensuring that only good quality food is preserved and passed on for further processing.

Grading is the assessment of a number of food characteristics to obtain an indication of their overall quality. The technique is normally carried out by trained operators. Meats, e.g. are examined by inspectors for disease, fat distribution, carcase size and shape. Other graded products include cheese and tea. In some cases, grading is based on laboratory analysis results.

In the wine industry, grading covers the necessary classification of the grapes harvested according to their degree of maturity, e.g. sugar content. Many characteristics cannot be examined automatically and trained operators are employed to simultaneously assess several characteristics to produce a uniform high quality product. Grading is more expensive than sorting due to the high costs of the skilled personnel required.

Dehulling is the removal of hulls from vegetables and shells from cocoa beans. To remove the shells from cocoa beans, the beans are first broken between adjustable toothed rollers. The broken pieces are subsequently separated in fractions by sieving. Each fraction is treated with a stream of air that carries the light shell pieces away. This breaking and fanning process is often referred to as winnowing.

Dehulling is also used in soybean crushing processes. The dehulling of soybeans is always preceded by a heating step, which enhances the removal of the hulls. The ease of dehulling vegetables depends on the thickness of the seed coat and can be achieved via wet or dry methods. The wet method involves soaking the vegetables in water for a few hours, draining, drying, milling and then blowing them with air to remove the seed coat. In the dry method, oil is mixed with the seeds by passing them through emery-coated rollers to abrade the surface. This is common practice for vegetables with particularly tough seed coats.

Destemming or destalking is the removal of fruit and vegetable stems, e.g. grapes. It is used for winemaking.

Trimming is used for the removal of either inedible parts or parts with defects, or for cutting the raw material to a size that is suitable for further processing. Trimming can be carried out manually or by rotating knives.

2.1.1.3 Peeling (A.3)

2.1.1.3.1 Objective

The objective of peeling is to remove the skin/peel from raw fruit and vegetables. This improves the appearance and taste of the final product. During peeling, the losses need to be minimised by removing as little of the underlying food as possible but still achieving a clean peeled surface.

2.1.1.3.2 Field of application

Peeling is applied on an industrial scale to fruits, vegetables, roots, tubers and potatoes.

2.1.1.3.3 Description of techniques, methods and equipment

Various methods for peeling are steam peeling, knife peeling, abrasion peeling, caustic peeling and flame peeling. These techniques are described in Sections 4.7.3.4 to 4.7.3.4.7 inclusive.

2.1.1.4 Washing (A.4)

2.1.1.4.1 Objective

This section applies to washing the FDM materials only and not cleaning the equipment or the process installation. The objective of washing is to remove and separate unwanted components to ensure that the surface of the food is in a suitable condition for further processing. Unwanted components can include dirt or residual peel, brine used for preservation, soil, micro-organisms, pesticide residues and salts.

2.1.1.4.2 Field of application

Washing is widely applied as a first processing step for root crops, potatoes, cereals, fruit and vegetables.

2.1.1.4.3 Description of techniques, methods and equipment

There are many types of machines and systems that have been adapted for washing material. Washing can be carried out by vigorous spraying with water, or by immersion with the aid of brushes, or by shaking and stirring. Sometimes cleaning substances are added. Warm water may be used but this can accelerate chemical and microbiological spoilage unless careful control of the washing time and process is carried out.

The dirt, once loosened, usually differs so greatly from the product that the actual separation of dirt and product is normally straightforward, e.g. by sedimentation. Semi-processed vegetables may arrive at the installation in strong brines, if so, the excess salt needs to be removed by rinsing with running water.

2.1.1.5 Thawing (A.5)

2.1.1.5.1 Objective

When raw materials, i.e. fish and meat, are received frozen, thawing is needed before further processing is carried out. Thawing is sometimes called defrosting. In this document, the word defrosting is used to describe the removal of frost from the inside of a refrigerator or coldstore.

2.1.1.5.2 Field of application

Since the processing of frozen meat and fish is common, thawing is widely applied in these sectors. It is also used in some other sectors such as in the production of ready-to-eat meals.

2.1.1.5.3 Description of techniques, methods and equipment

Thawing at ambient temperatures is slow compared to using water or hot air. The latter may cause a rapid growth of micro-organisms on the surface layers of the thawed product and hinder reabsorption of thawed water. This creates the unsightly and often nutritionally wasteful drip loss. The use of microwave energy, which is not transferred by conduction through the thawed food layers, is a faster and less damaging thawing process.

The traditional thawing of meat and fish takes place under running water. In this case, the unpacked meat or fish are completely immersed in pools with water. Meat and fish can also be thawed with air at controlled temperatures. Thawing by sprinkling is also applied. Desalting and thawing are carried out simultaneously.

2.1.2 Size reduction, mixing and forming (B)

2.1.2.1 Cutting, slicing, chopping, mincing, pulping and pressing (B.1)

2.1.2.1.1 Objective

The objective of cutting, slicing, chopping, mincing, pulping and pressing is to reduce the size of material either for further processing or to improve the eating quality or suitability for direct consumption.

2.1.2.1.2 Field of application

These operations are widely applied in the FDM sector. For example, they are used in the processing of meat, fish, cheese, vegetables, fruit, potatoes, and various crops, e.g. sugar beet.

2.1.2.1.3 Description of techniques, methods and equipment

A large variety of equipment is available, normally adapted to the product to be processed. Equipment can be power or hand-operated, depending on the size of the operations.

Cutting is used for size reduction of large to medium sized materials. Knives, blades, cleavers or saws are usually used for cutting. Cutting is an important operation in meat and fish processing. The cutting of meat is used post slaughtering to dress and split carcasses, to remove offal and to remove appendages and is covered in the “Slaughterhouse and animal by-products BREF”. At meat installations, carcasses are further reduced into retail cuts of joints by the removal of bone, skin and fat. Meat prepared for further processing into, e.g. ham, bacon or sausage, is initially treated in a similar manner to fresh meat, and will then be subject to further processing operations. These may include deboning, derinding, defatting, slicing, chopping, mincing and emulsifying. The cutting equipment used in meat processing includes power operated cleavers, circular or straight saws for splitting carcasses, and band saws for the further reduction of the carcasses. These are all electrically operated. Special derinding machines are used for separating rind and fat from pork. The cutting of potatoes for the production of potato chips often involves the use of hydro cutters where the potatoes are conveyed by water at high speed over fixed blades.

Slicing produces pieces of material of equal thickness. Slicing equipment consists of rotating or reciprocating blades which cut the food when it passes beneath. Sometimes the material is pressed against the blades by centrifugal force. In other cases, e.g. for slicing meat products, the material is held on a carriage as it travels across the blade. Hard fruit, such as apples, are simultaneously sliced and de-cored as they are forced over stationary knives inside a tube. In the sugar industry, sugar beets are cut into thin slices, called “cossettes”.

A variant of slicing is dicing and is applied to meat, fruits and vegetables. In dicing, the food is first sliced and then cut into strips by rotating blades. The strips are passed on to a second set of rotating knives, which operate at right angles to the first set, and cut the strips into cubes.

Chopping breaks down raw materials into small particles. Chopping into a coarse pulp is applied to meat, fruits and vegetables. In chopping, the material is placed in a slowly rotating bowl and subjected to a set of blades rotating at high speed. This technique, also called bowl chopping, is widely used in the production of sausages and similar products. The degree of size reduction can be varied depending on the knife-speed and cutting time, and in extreme cases, the material can be reduced to an emulsion if required.

Mincing is mainly used for the size reduction and homogenisation of meat. A meat grinder is used to mince the meat. This is a lightly constructed screw press with a cutting plate or rotating knives at its outlet. The process is a combination of cutting and extrusion, where the meat is passed through a plate with orifices.

Pulping is mainly used for the size reduction and homogenisation of fruit and vegetables. A moving rough surface ruptures the fruit or vegetables and squeezes the material through a gap producing an homogenised mass. The most common pulpers are drum pulpers and disc pulpers. Sometimes the pulping process is used for juice extraction.

Pressing is applied to extract the liquid part of grapes, other raw materials or marc after maceration. Pressing is used in wine production, for some other alcoholic drinks and for fruit and vegetable juices.

There are two main types of press. The horizontal pneumatic press comprises an inflated pneumatic membrane located in the centre of the press. Berries are slowly pressed releasing the juice, usually known as must in wine, cider and perry making, in a tank, while the solid parts remain in the press. In a hydraulic compression vertical press, grapes are placed in a cage which contains them during the pressing. A horizontal tray presses the grapes vertically and the must which flows through the cage is collected in a tank for further processing. The grapes remain in the cage. There are also other types of presses, e.g. belt presses and horizontal presses.

2.1.2.2 Mixing/blending, homogenisation and conching (B.2)

2.1.2.2.1 Objective

The aim of this group of operations is to obtain a uniform mixture of two or more components or to obtain an even particle size distribution in a food material. This can also result in improved characteristics and eating quality.

2.1.2.2.2 Field of application

These operations are widely applied in almost all FDM sectors.

2.1.2.2.3 Description of techniques, methods and equipment

Mixing or blending is the combination of different materials. The spatial distribution of the separate components are reduced to obtain a certain degree of homogeneity. Various mixing operations can be distinguished in the FDM sector.

Mixing solids with solids is carried out, e.g. during the production of animal feed, blends of tea and coffee, dried soup, cake mixes, custard, ice-cream mixes and malt blends. Mixing equipment commonly used includes rotating drums, rotary mixers, paddle and ribbon mixers and mixing screws in cylindrical or cone-shaped vessels and variable speed drive screws. Generally, cyclones are used as an integral part of the process to recover dust from the extracted air. The recovered material is then reprocessed.

Mixing solid with liquid is carried out, e.g. during the production of canned foods and dairy products. This type of mixing is also used in, e.g. the production of chocolates and sweets, where the ingredients are mixed in a more or less liquid state and solidify on cooling. For viscous mixtures, kneading machines are used. For low viscosity mixtures various types of stirrers, impellers and agitators are used.

Mixing liquid with liquid is carried out, e.g. during the production of emulsions like mayonnaise, margarine and mixtures of solutions. This type of mixing is also used to blend different wines or mineral waters with each other or with additives or extra ingredients. Various types of stirrers, impellers and agitators are used.

Finally, mixing liquid with gas is carried out, e.g. when making ice-cream, whipped cream and some sweets. During spray drying, the liquid-phase is mixed in a stream of gas. Atomisers are used to produce small liquid droplets, which are brought into contact with a stream of gas. When making ice-cream, whipped cream or a foam, small gas bubbles are fed into a liquid.

The aim of **homogenisation** is to attain a more even particle size or a more homogeneous blend of materials. It is, e.g. applied to whole milk to reduce the size of fat globules so that they stay evenly divided in the milk, thereby preventing the fat separating and the cream rising. The liquid, i.e. whole milk, is pressed under high pressure, 200 to 300 bar, through a small orifice.

Conching is a special method of kneading used in the chocolate industry. The molten chocolate mass is placed in a special trough-shaped vessel and is kneaded by a granite roller moving slowly back and forth. The aim of conching is to reduce the viscosity of the mass and to improve the flavour and the texture.

2.1.2.3 Grinding/milling and crushing (B.3)

2.1.2.3.1 Objective

Grinding or milling is used for the size reduction of solid dry material. It may also improve the eating quality and/or suitability of the material for further processing. It is the main process in the cereal and animal feed industry and is also used to crush cane sugar and to facilitate the extraction of sugar in sugar and rum factories. **Crushing** covers, for instance, breaking the skin of berries and grapes to liberate the must.

2.1.2.3.2 Field of application

Grinding or milling is applied where dry solid materials are processed, e.g. in the flour milling, animal feed, semolina, brewing, sugar and dairy sectors. **Crushing** is necessary to facilitate the yeasts' multiplication and also to conduct traditional macerations before pressing, e.g. in winemaking.

2.1.2.3.3 Description of processing techniques, methods and equipment

A whole range of **grinding or milling** techniques and equipment are available for application with different types of food. It can be carried out dry or wet. In wet grinding or milling, smaller particle sizes can be attained. Often the dry technique is combined with sieving or air classification, which results in particle size fractions. Generally abatement systems, e.g. cyclones, are used as an integral part of the process, to recover dust from the extracted air. The recovered material is then reprocessed.

The common types of mills used in the FDM sector are hammer mills, ball mills, roller mills and disc mills. A hammer mill consists of a horizontal or vertical cylindrical chamber lined with a steel breaker plate and contains a high speed rotor fitted with hammers along its length. The material is broken apart by impact forces as the hammers drive it against the breaker plate. A ball mill consists of a slowly rotating horizontal steel cylinder, half filled with steel balls of 2.5 to 15 cm diameter. The final particle size depends on the speed of rotation and on the size of the balls. A roller mill consists of two or more steel rollers which revolve towards each other and pull particles of the food material through the space between the rollers, the space is known as the nip. The size of the nip can be adjusted for different food materials. A disc mill consists of either a single rotating disc in a stationary casing or two discs rotating in opposite directions. The food material passes through the adjustable gap between the disc and the casing or between the discs. Disc mills have intermeshing pins fixed onto the discs and casing. This improves the effectiveness of the milling.

2.1.2.4 Forming/moulding and extruding (B.4)

2.1.2.4.1 Objective

Forming or moulding and **extruding** are operations used to achieve a specified shape for solid materials.

2.1.2.4.2 Field of application

Forming or moulding is an operation widely applied in the production of chocolate, bread, biscuits, confectionery and pies. It is also an important process step in cheesemaking. **Extruding** is widely used in the production of meat sausages, confectionery products and starch-based snack foods.

2.1.2.4.3 Description of techniques, methods and equipment

In **forming or moulding**, the material is in a viscous form and is fed into the appropriate mould. As the moulding process progresses, the material becomes firmer and solidifies up to the point that it becomes a fixed shape.

Extruding is a continuous process of shaping. The material is kneaded under high pressure and pressed continuously through openings of the required shape. In cooking extruders, the material is also heat-treated or cooked, to solubilise starches. Extruders can contain one or two screws. The rotation of the screws transports and mixes the material and produces pressure build-up.

2.1.3 Separation techniques (C)

2.1.3.1 Extraction (C.1)

2.1.3.1.1 Objective

The objective of extraction is to recover valuable soluble components from raw materials by primarily dissolving them in a liquid solvent, so that the components can be separated and recovered later from the liquid. It is not always the objective to recover one particular compound in pure form from a raw material, i.e. sometimes extraction is intended to separate all of the soluble compounds from the residue; an example of this is the extraction of coffee.

2.1.3.1.2 Field of application

Extraction is widely applied in the FDM sector. For example, in the extraction of sugar from sugar beets or sugar cane, oil from oilseeds and from virgin pomace, coffee extract from coffee beans, caffeine from coffee beans and various other compounds such as proteins, pectins, vitamins, pigments, essential oils, aroma compounds and flavour compounds from many different materials.

2.1.3.1.3 Description of techniques, methods and equipment

Extraction works according to the principle that soluble components can be separated from insoluble or less soluble components by dissolving them in a suitable solvent. Raw materials that are suitable for extraction may contain either solids only, solids and a solution, or solids and a liquid. Solid/liquid extraction is sometimes called leaching. When the soluble component is incorporated in a liquid, the extraction may be applied to recover the valuable soluble component. Commonly, the extract is the product or intermediate product and the residue is a waste or by-product. The efficiency of the extraction process depends on the selectivity of the solvent. Common solvents include water, organic solvents such as hexane, methylene chloride, ethyl acetate and alcohol. Supercritical CO₂ is used in coffee extraction.

Raw materials are usually pretreated to ensure efficient extraction of the desired compounds. For example, sugar beets and sugar cane are cut into thin slices, nuts and seeds are ground or flaked, coffee beans are roasted and ground, and tea leaves are dried and ground.

The simplest extraction method is a repeated extraction with fresh solvent called lateral flow extraction. However, this is rarely used because of the costs of the solvent and because it results in a very low concentration extract. The most common method used is countercurrent extraction, either in a batch or continuous process. Batch wise countercurrent extraction is normally only used for the processing of small amounts of material. In continuously operating extractors, the solid material and the solvent flow countercurrently. One difficulty with extraction is the recovery of the extracted material from the solvent. This can be carried out by evaporation, crystallisation, distillation or steam stripping.

In principle, many different methods of transport are possible for material and liquid flows. Some examples of transport systems commonly used include perforated trays connected to an unbroken conveyor or loop, moving horizontally or vertically; screw conveyors which transport the solid material in a countercurrent flow vertically or upwards under an incline slope, the screws are perforated to obtain a uniform flow of liquid and finally, an unbroken perforated belt where the solvent is circulated under pump action and sprayed on top of the solid material.

2.1.3.2 Deionisation (C.2)

2.1.3.2.1 Objective

Deionisation or ion exchange is used to remove unwanted organic and/or inorganic constituents from water and food products. See also electro dialysis in Section 2.1.3.6.

2.1.3.2.2 Field of application

In the dairy industry, deionisation is applied in whey processing. For the application of whey solids in human food and in baby food, low levels of mineral constituents are required. Deionisation is also widely used in the FDM sector for the treatment of boiler feed-water for power and steam generation and for the production of deionised process water. Deionisation is also applied to remove minor ionised organic substances.

2.1.3.2.3 Description of techniques, methods and equipment

Deionisation is normally carried out by passing the product through a column containing ion exchange resin beads. The beads contain a large number of active sites which are capable of holding a wide variety of metals, non-metal inorganic molecules and ionised organic constituents. The columns are operated batch wise and need to be regenerated when the beads are exhausted or saturated. This is normally carried out by treatment of the columns and beads with a variety of chemicals which remove the impurities and regenerate the active sites.

2.1.3.3 Fining (C.3)

2.1.3.3.1 Objective

Fining is the process of clarifying liquids, i.e. removing suspended particles which give the liquid a cloudy appearance.

2.1.3.3.2 Field of application

The production of sparkling wines and beer.

2.1.3.3.3 Description of techniques, methods and equipment

The fining agent introduced causes the minute hazy particles to flocculate and precipitate out of solution. These particles are proteins, polysides, polyphenols, ferrous or cupreous complexes. For the fining action to take place, the electrical charges between the fining agent and the particles must be opposed, which means that it is necessary to carefully choose the fining agent depending on the effect sought. The nature and the dose of the fining agent can be determined by laboratory tests. Moreover, some other treatments can be technically classed as examples of the fining process, such as iron elimination with potassium ferrocyanide.

The fining agents used can be divided into two major groups; organic and mineral fining agents. Some organic fining agents are gelatine, ichthyocolla, egg albumin, blood albumin, algein, caseins and caseinates. Some mineral fining agents are bentonites, silica gel and oenological tannins.

2.1.3.4 Centrifugation and sedimentation (C.4)

2.1.3.4.1 Objective

Centrifugation and sedimentation are used to separate immiscible liquids and solids from liquids. Separation is carried out by the application of either centrifugal forces or natural gravity.

2.1.3.4.2 Field of application

Typically used in the dairy industry in the clarification of milk, the skimming of milk and whey, the concentration of cream, the production and recovery of casein, in the cheese industry, and in lactose and whey protein processing. It is also used in drink technology, vegetable and fruit juices, coffee, tea, beer, wine, soy milk, oil and fat processing/recovery, cocoa butter manufacturing, sugar manufacturing and waste water treatment.

2.1.3.4.3 Description of techniques, methods and equipment

When the differences in density are large and time is not a limiting factor, natural gravity is applied. This process is called **sedimentation** and can be batch wise or continuous. The batch wise process occurs in a vessel containing a dispersion of solid particles with a higher density than the liquid. In time, these heavier particles fall to the bottom of the vessel. If the height of the vessel is shortened and the surface increased, the sedimentation time can be reduced. In the continuous process, the liquid containing the slurried particles is introduced at one end of the process and flows towards an overflow. The sedimentation capacity of the vessel can be increased by adding horizontal or inclined baffle plates.

Centrifugation is used to separate mixtures of two or more phases, one of which is a continuous phase. There are two general ways to operate centrifuges. Continuous systems and systems with breaks for cleaning. In continuous systems, the sludge can be discharged during the process. The driving force behind the separation is the difference in density between the phases. By using centrifugal forces, the separation process is accelerated. The necessary centrifugal forces are generated by rotating the materials. The force generated depends on the speed and radius of rotation. In raw milk, e.g. the skimmed milk is the continuous phase, the fat phase is a discontinuous phase formed of fat globules with diameters of some microns, and a third phase consists of solid particles. In beer production, clarification of the hot wort is carried out to remove hot trub particles to get a clear wort. The commonly used equipment for wort clarification is the hydrocyclone, where wort trub particles are separated in tangential flow.

Centrifuges are classified into four groups:

- tubular and disc bowl centrifuges
- solid bowl and nozzle or valve discharge centrifuges
- conveyor bowl, reciprocating conveyor and basket centrifuges
- hydrocyclones or whirlpools.

A tubular bowl centrifuge consists of a vertical cylinder, which rotates at 15000 to 50000 rpm, inside a stationary casing. It is used to separate immiscible liquids, e.g. vegetable oil and water or solids from liquid. The two components are separated into annular layers, with the denser liquid or solid setting nearer to the bowl wall. The two layers are then discharged separately. Typically, the disc bowl centrifuge is more widely used in the FDM sector as it can achieve a better separation due to the thinner layers of liquid formed. The cylindrical bowl contains inverted cones or discs and the liquids only have to travel a short distance to achieve separation. These centrifuges operate at 2000 to 7000 rpm and have capacities of up to 150000 l/h. Disc bowl centrifuges are used to separate cream from milk; to clarify oils, coffee extracts and juices or to separate starch from slurry.

A solid bowl centrifuge is the simplest solids/liquid centrifuge and is useful when small amounts of solids must be removed from large volumes of liquid. It consists of a rotating cylindrical bowl. Liquor is fed into the bowl; the solids settle out against the bowl wall whilst the liquid spills over the top of the bowl. Cakes can also be removed without stopping the centrifuge. Liquors containing higher levels of solids, i.e. >3 % w/w, can be separated using nozzle or valve discharge centrifuges. These centrifuges are a modified disc bowl centrifuge with a double conical bowl which enables the automatic discharge of solids. These types of centrifuges are used to treat oils, juices, beers and starches to recover solid parts, e.g. yeast cells. They have capacities of up to 300000 l/h. A special type is the bactofuge, which is a high speed centrifugal process which separates bacterial cells and spores from milk.

The conveyor bowl or decanter, reciprocating conveyor and basket centrifuges are used when the feed contains high levels of solids or sludges. They are used to recover animal protein, e.g. precipitated casein from skimmed milk, vegetable proteins, to separate coffee, cocoa and tea slurries and to remove sludge from oils. In the conveyor bowl centrifuge, the solid bowl rotates at 25 rpm faster than the screw conveyor. This causes the solids to be conveyed to one end of the centrifuge whereas the liquid fraction moves to the other larger diameter end. The reciprocating conveyor centrifuge is used to separate fragile solids, e.g. crystals from liquor.

The feed enters a rotating basket through a funnel, which rotates at the same speed. This gradually accelerates the liquid to the bowl speed and thus minimises shear forces. Liquid passes through perforations in the bowl wall. When the layer of solids has built up, it is pushed forward by a reciprocating arm. The basket centrifuge has a perforated basket lined with a filtering medium, which rotates at 2000 rpm. Separation occurs in cycles, which last from 5 to 30 minutes. In the three stages of the cycle, the feed liquor first enters the slowly rotating bowl, the speed is then increased and separation takes place, finally the speed of the bowl is reduced and the cake is discharged through the base. Capacities are up to 90000 l/h.

A typical hydrocyclone comprises a conical section terminating in a cylindrical section. The hydrocyclone is fitted with a tangential inlet and closed with an end plate, with an axially mounted overflow pipe or vortex finder. The end of the conical portion terminates in a circular apex opening. During operation, the slurry is forced, under pump pressure, through the tangential inlet and this produces a strong swirling motion. The fraction of the slurry contains the lighter particles discharged through the overflow, and the remaining slurry and solids are discharged through the underflow opening.

2.1.3.5 Filtration (C.5)

2.1.3.5.1 Objective

Filtration is the separation of solids from a suspension in a liquid by means of a porous medium, screen or filter cloth, which retains the solids and allows the liquid to pass through. Air filtration is discussed in Sections 4.4.3.7.1, 4.4.3.7.2 and 4.4.3.7.3.

2.1.3.5.2 Field of application

Filtration is used in the FDM sector to clarify liquid products by the removal of small amounts of solid particles with the subsequent recovery of the filtrate, e.g. for wine, beer, oils and syrups, and to separate a liquid from a significant quantity of solid material to obtain the filtrate or cake, or both, e.g. for fruit juices or beer.

2.1.3.5.3 Description of techniques, methods and equipment

The technique operates either by **pressure filtration**, i.e. applying pressure to the feed side, or by **vacuum filtration**, i.e. applying a vacuum to the filtrate side.

The two main types of **pressure filtration** are the plate and frame filter press and the leaf filter.

The plate and frame filter press consists of plates and frames arranged alternately and supported on a pair of rails. The hollow frame is separated from the plate by the filter cloth. The slurry is pumped through a port in each frame and the filtrate passes through the cloth and flows down the grooved surfaces of the plates and is drained through an outlet channel in the base of each plate. The filter operates at a pressure of between 250 to 800 kPa. The filter press is operated batch wise; the optimum cycle time depends on the resistance offered by the filter cake and the time taken to dismantle and refit the press. This press can be used when the dismantling, emptying and refitting of the presses are carried out in a semi-automatic manner. Sometimes, filter aids such as perlite or diatomaceous earth are used as a pre-coat or body feed to improve the filtration. The equipment is reliable and easily maintained, and is widely used, particularly for the production of apple juice and cider and in edible oil refining. A special type of plate and frame filter press is the membrane filter press. A membrane is mounted onto the plate which can be pressurised with air or water. Due to the higher pressure on the filter cake, up to 20 bar, more liquid is recovered resulting in a dryer filter cake.

The need to develop much larger capacity units led to the introduction of the leaf filters. These consist of mesh leaves which are coated in filter medium and supported on a hollow frame, which forms the outlet channel for the filtrate. The leaves can be stacked horizontally or vertically. Feed liquor is pumped into the shell at a pressure of approximately 400 kPa. When the filtration is completed, the solid residue is blown or washed from the leaves.

Vacuum filters are normally operated continuously. Liquor is sucked through the filter plate or cloth and the solids are deposited on the cloth. The pressure difference on the downstream side of the filter plate is normally limited to 100 kPa due to the cost of vacuum generation. Sometimes, filter aids are used as a pre-coat or body feed to improve filtration. In these cases, a knife is used to scrape off the solid residue. Two common types of vacuum filter are the rotary drum filter and the rotary vacuum disc filter.

Rotary drum filters consist of a slowly rotating cylinder, which is divided into compartments, which are themselves covered with a filter cloth and connected to a central vacuum pump. As the drum rotates, it dips into a bath of liquor. The filtrate flows through the filter cloth of the immersed compartment. When the compartment leaves the bath, the filter cake is sucked free of liquor and washed. As the drum rotates further, the vacuum is released for the compartment in question and the cake is loosened from the cloth by the application of compressed air, and then removed by means of a scraper. The same procedure occurs for each compartment in turn as the cycle is repeated.

Rotary vacuum disc filters consist of a series of vertical discs which rotate slowly in a bath of liquor in a similar cycle to drum filters. Each disc is divided into segments and each segment has an outlet to a central shaft. The discs are fitted with scrapers to continuously remove the solid residue.

2.1.3.6 Membrane separation (C.6)

2.1.3.6.1 Objective

Membrane separation is aimed at the selective removal of water, solutes and/or suspended material from a solution by using semi-permeable membranes. It is considered to be a fractionation technique.

2.1.3.6.2 Field of application

Membrane separation is applied for the concentration of liquids, e.g. with cheese whey, the removal of salts from whey or water, whey fractionation, and water purification.

2.1.3.6.3 Description of techniques, methods and equipment

There are two membrane separation techniques used in the FDM sector, i.e. membrane separation and electro dialysis.

Membrane separation is a pressure driven filtration technique in which a solution is forced through a porous membrane. Some of the dissolved solids are held back because their molecular size is too large to allow them to pass through. The size range depends upon the type of membranes used. Fractionation of the feed stream occurs, with some molecules being concentrated on the upstream side of the membrane, which is known as the concentrate or retentate. The smaller molecules pass through the membrane into the permeate stream.

The various membrane separation techniques can be characterised by their membrane pore size. Cross-flow microfiltration (CMF), can be used to remove bacteria from skimmed milk, or for fractionation of the skimmed milk into a casein rich retentate and a milk serum devoid of casein; the membrane pore size ranges from about 0.1 to 5 μm . Ultrafiltration (UF) is applied to both skimmed milk and whey, to concentrate the respective protein components; the membrane pore size ranges from about 10 to 100 nm. Nanofiltration (NF) membranes have selective permeability for minerals and some small organic and inorganic molecules and NF is used predominantly for concentration and pre-demineralisation (removal of salt) of whey; the pore sizes of the NF membrane range from about 1 to 10 nm. Reverse osmosis filtration (RO) membranes are permeable to water but not minerals and are, therefore, used for dewatering; concentration of whey or skimmed milk; or for polishing NF permeates or evaporator condensate and in water treatment, e.g. softening and salt removal; the membrane pore size ranges from about 0.1 to 1 nm.

Electrodialysis is a membrane separation process undertaken in the presence of an applied electro potential. Low molecular weight ions migrate to an electrical field across cationic or anionic membranes. These membranes are alternately arranged between the cathode and anode within a stack. It is principally applied in the dairy industry for the removal of salt from whey.

2.1.3.7 Crystallisation (C.7)

2.1.3.7.1 Objective

The objective of crystallisation is to separate a solute from a solvent.

2.1.3.7.2 Field of application

Crystallisation is applied in the dairy industry, where lactose is produced from cheese whey or casein whey, and the sugar industry. It is also used in the edible oil industry to modify the properties of edible oils and fats; in this case it is also called fractionation.

2.1.3.7.3 Description of the technique, methods and equipment

Crystallisation is the formation of solid crystals from a solution. Crystals solidify in a definite geometric form. They are usually grown by the introduction of nuclei into a supersaturated solution. Any impurities in the liquid are usually not incorporated into the lattice structure of the desired crystal. Accordingly, crystallisation is also a purification process.

2.1.3.8 Removal of free fatty acids (ffa) by neutralisation (C.8)

2.1.3.8.1 Objective

The objective of the chemical neutralisation process is to remove the ffa and the phosphatides from vegetable oils, using caustic and phosphoric acid or, in some cases, citric acid.

2.1.3.8.2 Field of application

Chemical neutralisation is applied in the refining process of vegetable oils such as soybean oil, sunflower oil, rapeseed oil, and of animal oils and fats such as tallow or fish-oil.

2.1.3.8.3 Description of techniques, methods and equipment

The oil is preheated using steam, after which phosphoric acid or citric acid is mixed with it to increase the water solubility of the phosphatides. The acidified oil, with a crude oil content of 0.5 to 6 %, is then mixed with a caustic solution, which neutralises both the ffa and the phosphoric or citric acid, and further increases the water solubility of the phosphatides. The aqueous mixture of soap and phosphatides, which is known as soap-stock, is separated from the oil by centrifugation. The oil is mixed with water to wash off the rest of the soaps. Again, the water is removed from the oil by centrifugation. The caustic refined oil may be dried under vacuum conditions and then pumped to a storage tank. The process is typically operated in a continuous way, as shown in Figure 2.1, but it can also be a semi-continuous or batch process, using long period mixing and sedimentation equipment.

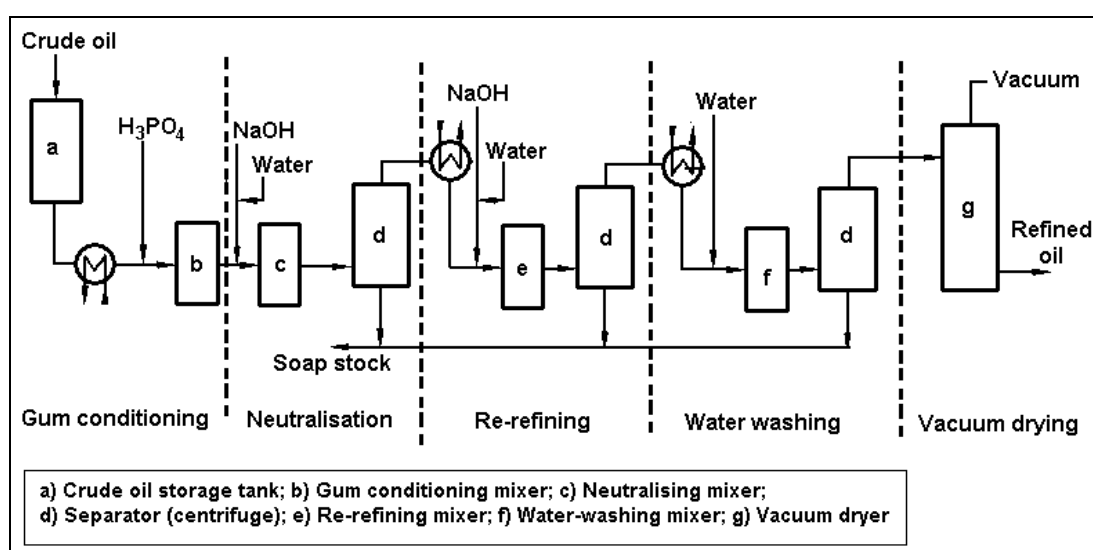

Figure 2.1: Flow diagram of continuous neutralisation of oils and fats [87, Ullmann, 2001]

The centrifuge aqueous discharges, i.e. the soap-stocks, are combined and further treated in a soap-stock splitting system. This acidulation process is used to recover the ffa after treatment with concentrated acid, usually sulphuric acid or occasionally hydrochloric acid, and heating with steam. The separated ffa are then removed in a decanter centrifuge. In integrated installations, the soap-stock can be added to the meal toasting process. The phosphatides recovered are used as lecithin in human food or in animal feed.

2.1.3.9 Bleaching (C.9)

2.1.3.9.1 Objective

The objective of bleaching is to remove pigments, metals, e.g. nickel or iron from other oil refinery processes; residual soaps and phospholipids from the oil or fat.

2.1.3.9.2 Field of application

Bleaching is applied in the refining of edible oils and fats.

2.1.3.9.3 Description of techniques, methods and equipment

Edible oils and fats are mixed with bleaching earth that has an affinity for adsorbing the above-mentioned undesirable compounds. The oil is mixed under vacuum conditions with 0.1 to 3 % of bleaching earth. This is a clay mineral, such as bentonite or montmorillonite, that has been activated by thermal and/or acidic or other treatments. These earths, sometimes mixed with small amounts of activated carbon, have a very high adsorbing capacity. After bleaching for 30 to 90 minutes, the oil is separated from the bleaching earth, using filters. The spent earth contains high amounts of oil, up to 30 %. A steam stripping process can recover a part of the oil or fat. Used bleaching earth can be added to the meal in integrated installations. The bleached oil is further treated in other refinery processes. The equipment used for bleaching consists of mixing vessels, vacuum generators and filters.

2.1.3.10 Deodorisation by steam stripping (C.10)

2.1.3.10.1 Objective

The objective of deodorisation is to remove ffa and other highly volatile compounds from crude degummed and/or alkali refined edible oils and fats after bleaching.

2.1.3.10.2 Field of application

Deodorising is applied in the refining of edible oils and fats.

2.1.3.10.3 Description of techniques, methods and equipment

Deodorisation is the use of steam distillation to strip ffa and other highly volatile components, under vacuum conditions, from oils and fats. The equipment used for deodorisation consists of a steam distillation column, barometric condenser, demisters and scrubbers. Steam is injected into the oil heated to over 200 °C at the bottom of the distillation column, which is under vacuum conditions. The steam strips the ffa and other impurities from the oils and fats but gums are not removed by this process. The steam is condensed afterwards, using a barometric condenser of either once-through or closed-circuit design (see Section 2.1.9.4). The separation of the volatile components from this steam can be enhanced by a one-stage or a two-stage scrubbing/condensation system and by demisters. Deodorisation can be operated in batch or continuous deodorising vessels.

2.1.3.11 Decolourisation (C.11)

2.1.3.11.1 Objective

Decolourisation is carried out to improve the colour, purity, ageing, microbiological stability and shelf-life of certain food products.

2.1.3.11.2 Field of application

Decolourisation is used in the sugar, glucose, syrup and fermentation industries.

2.1.3.11.3 Description of techniques, methods and equipment

Decolourisation can be carried out by the addition of an active powder, e.g. powdered activated carbon, to the product in aqueous solution, which is then mixed under controlled conditions. Afterwards, the powder is removed by filtration, using static filters or rotary vacuum filters, while the decoloured product is processed further. This process is often carried out in multiple stages with the active material being re-used until exhausted, often using a countercurrent system.

The process can also be carried out by passing the product in aqueous solution through a column of active material, e.g. using granular activated carbon or ion exchange resin beads. Here, only minimal filtration is required after the process as the active material is held in place. Active material is withdrawn from the column at regular intervals and replaced by new or reactivated material.

The main purpose of both these operations is to remove colour molecules from the product as well as precursors that may give rise to colour formation on storage, which is known as ageing. The majority of the impurities removed are organic in nature. Passage over activated carbon may also be helpful in removing phenolic material, which may cause taints, pesticide residues and some heavy metals.

2.1.3.12 Distillation (C.12)

2.1.3.12.1 Objective

Distillation is the separation of the components of a liquid mixture by partial vaporisation of the mixture and separate recovery of the vapour and residue. The more volatile components of the original mixture are obtained at a higher concentration in the vapour, the less volatile in a higher concentration in the liquid/solid residue.

2.1.3.12.2 Field of application

Distillation enables the separation and purification of volatile food products from aqueous blends. Distillation can be used to separate flavours or essential oils, but is mainly used either for the production of potable alcohol or spirits, or for the industrial production of alcohol from agricultural raw materials, e.g. fruit and grain, which can then be used in alcoholic drinks or liquors. Distillation normally follows alcoholic fermentation.

Spirit drinks production is regulated by Council Regulation (EEC) No 1576/89 [218, EC, 1989]. They are prepared from the distillate of the alcoholic yeast fermentation of products from agricultural origin.

2.1.3.12.3 Description of techniques, methods and equipment

The process takes place in two basic types of equipment; the pot still and the column still. Stills may be operated singly or in groups. The addition of heat enables the separation of alcohol/aqueous compounds from the initial liquid feed in the still. Condensed aqueous alcohol is removed as a liquid spirit from the head of the still, whilst a residual stream is discharged from the base.

The pot still can be operated in a batch or continuous manner. In the former case, a batch of material is charged to the still pot, boiling is initiated, and the vapours are then continuously removed, condensed and collected until their average composition has reached a desired value. When operated in a continuous manner, feed is continuously passed to the still pot with the vapour and liquid portions being continuously removed.

In column distillation, the alcoholic liquid or beer enters a distillation tower heated with vapour. In each contacting device, generally a tray, an equilibrium is created between the vapour enriched with volatile components and the condensed liquid. Crude alcohol is drawn off from the top of the tower and then rectified through another tower where 95 % of the alcohol is separated from higher alcohols. At the bottom of the first tower, an aqueous blend or stillage is drawn off. A condensed water or stillage water, contaminated slightly with organics, is drawn off at the bottom of the second tower once the alcohol has been dehydrated. 95 % alcohol can be turned into anhydrous alcohol by a number of different technologies. These technologies can include azeotropic distillation using a third component, adsorption by a molecular sieve, or dehydration by a membrane technique. Some spirits and ethyl alcohols of agricultural origin can be distilled higher than 84 %.

2.1.4 Product processing technology (D)

2.1.4.1 Soaking (D.1)

2.1.4.1.1 Objective

The objective of soaking, e.g. of vegetable seeds, such as lentils, is to moisten and soften the seeds to reduce the cooking time or to aid in seed coat removal. In the malting process, the objective of soaking is the uptake of water to activate the germination process in the kernel.

2.1.4.1.2 Field of application

Soaking is predominantly applied in the processing of vegetable seeds. It is also applied with grain, where the grain is soaked in the malting process prior to germination. This is often called steeping.

2.1.4.1.3 Description of techniques, methods and equipment

Soaking is performed by putting the vegetable seeds in water for a specified time. The time needed varies, depending on the seed variety and species and with the length of storage and storage conditions. Traditionally, dry beans are soaked for 8 to 16 hours in cold water with appropriate hardness. High temperature soaking accelerates hydration. To steep the grain, the grain is immersed in water at about 16 °C, ranging from 10 to 25 °C, depending on the equipment, the process parameters, the raw material and the finished malt to be obtained. During steeping, the moisture content increases from 12 to 15 % to anywhere between 30 to 50 %, depending again on the above conditions. During steeping, the water in the steep tanks is changed one to three times. Alternate wet and dry stages are applied. During the wet stage, the grain is aerated continuously or at intervals. During the dry stage, the grain can be aerated or the CO₂ can be extracted. The steeping process takes one to three days. Figure 2.2 shows an example of a steeping procedure.

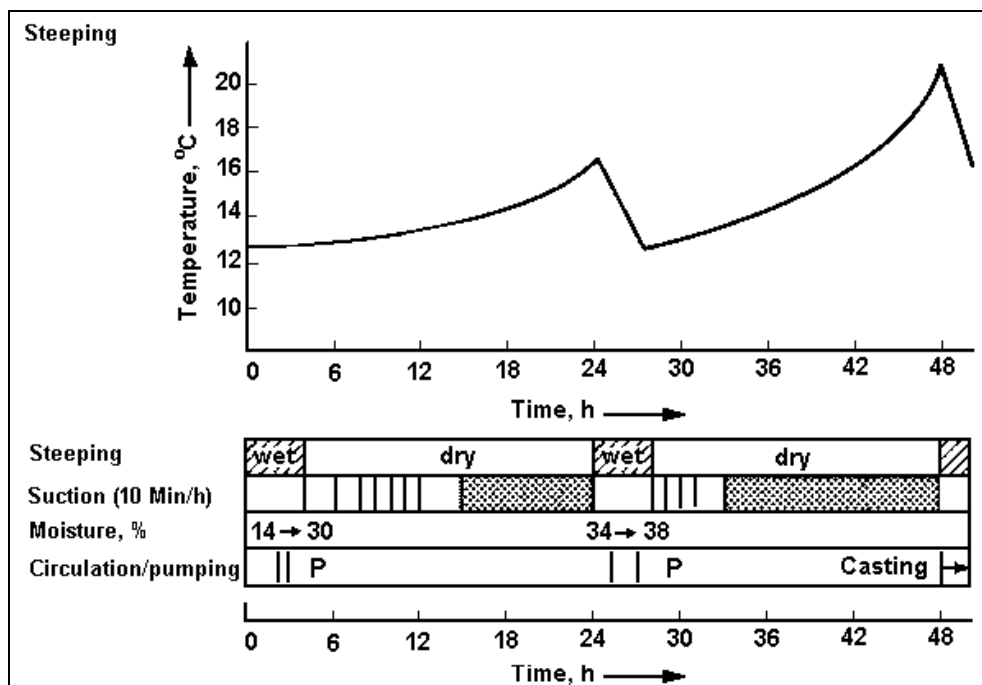

Figure 2.2: An example of the steeping procedure [87, Ullmann, 2001]

2.1.4.2 Dissolving (D.2)

2.1.4.2.1 Objective

Dissolving is the addition of powder to liquid to produce solutions or suspensions for further processing.

2.1.4.2.2 Field of application

This process is used in a variety of products to recombine and reformulate them. For example, dissolving is used for recombining or reformulating milks in the dairy industry.

2.1.4.2.3 Description of techniques, methods and equipment

A variety of processes and equipment are used for this purpose. Different mixing systems may be used for the same task, ranging from simple batch dissolving tanks with efficient mixing devices, to continuous mixing processes which involve either drawing solid materials into the liquid phase or mechanical powder injection into the liquids. Depending on the product, the liquid may be at ambient or elevated temperatures.

The main types of dissolving systems are:

- a blending pump that sucks the powder into the solvent. Used for total solids of up to 25 %
- jet dissolving which uses the venturi principle to suck powder into the solvent. Used for total solids of up to 30 %
- a dissolving tank with high shear mixing impeller. Used for total solids of up to 70 %
- a dissolving tank under vacuum with high shear impeller. Used for total solids of up to 30 %.

2.1.4.3 Solubilisation/alkalising (D.3)

2.1.4.3.1 Objective

Solubilisation or alkalising is the neutralisation of cocoa nibs or cocoa liquor with an alkaline solution, resulting in a darker colour and a milder taste. The milder taste is mainly the result of the neutralisation of the light acidity of fermented beans. Considerable experience and skill is required to obtain end-products with a constant colour and hue.

2.1.4.3.2 Field of application

Solubilisation is primarily used in cocoa processing.

2.1.4.3.3 Description of techniques, methods and equipment

The process is carried out by adding an alkali solution, usually potassium carbonate (K_2CO_3), to the cocoa. Two different methods can be applied, i.e. liquid process or nibs alkalising.

In the liquid process, the liquid cocoa liquor is processed. This allows the flavour to be modified. Potash solution is added to the liquor until a pH value of 7 to 8 is achieved. The desired solubility is obtained by increasing the temperature from 45 °C up to 130 °C. Water vapour and undesirable volatile components are released to the air during the heating phase.

During nibs alkalising, green or pre-dried nibs are processed. This has the advantage of combining the drying with the nibs roasting and the disadvantage of the presence of the cocoa butter in the nibs, which may result in slight damage to the fat. Batch and continuous processes are available. Batch processes consist of a solubilisation tank at atmospheric pressure with a high shear impeller. Continuous processes take place in a reactor followed by a mixing tank, usually under vacuum. A typical batch alkalising process involves two steps. First, the nibs are

neutralised by adding the alkaline solution in a reactive vessel at atmospheric pressure. The reaction takes place within a temperature range of 80 to 105 °C. In the second step, water evaporation and nibs roasting are carried out in a FBD.

2.1.4.4 Fermentation (D.4)

2.1.4.4.1 Objective

Fermentation is the controlled action of selected micro-organisms to alter the texture of foods, to preserve foods by the production of acids or alcohol, or to produce or modify flavours and aromas. It also preserves products by lowering the pH tolerance limits of many micro-organisms.

2.1.4.4.2 Field of application

Fermentation is an important processing step for a number of FDM products. Typical applications include beer, wine, various dairy products, vegetables, meat and fish.

Alcoholic fermentation is used in beer and winemaking and for the production of spirits, mostly with cereals, grape musts, sugar juices and molasses as a raw material. Lactic acid fermentation is used for making yoghurt and other fermented dairy products, fermented meat products such as certain types of sausages and vegetables, i.e. sauerkraut. In the lactic acid fermentation of vegetables, the sliced raw material, e.g. green cabbage in the case of sauerkraut production, is salted and then fermented under anaerobic conditions.

2.1.4.4.3 Description of techniques, methods and equipment

There are two types of fermentation processes, i.e. alcoholic fermentation and lactic acid fermentation.

The breakdown of simple sugars into alcohol is normally referred to as **alcoholic fermentation**. Yeasts, usually *Saccharomyces sp.*, e.g. *cerevisiae* or *bayanus*, are used to produce ethanol from carbohydrates and very small amounts of other organic compounds. This conversion can be represented by the following equation:

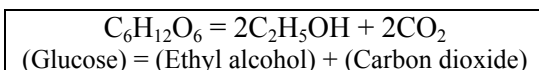

This is an anaerobic process, i.e. it does not require the presence of oxygen. The temperature of fermentation is usually in the range of 8 to 30 °C. The temperature affects the rate of fermentation, the efficiency of conversion and the flavour and the aroma of the finished product. The pH may also be adjusted. This ensures that the fermentation is efficient and produces the required flavour. The type of yeast species used affects the rate, efficiency, flavour and aroma and is, therefore carefully selected to give the desired results. Selected strains of yeasts are often used to optimise the alcohol yield and the production of aromatics as secondary components. Nitrogen, vitamins and trace elements are usually added as yeast nutrients. Traditionally, fermentation in beer and winemaking has been carried out in open fermentation vessels. Some have been replaced by cylindrical closed fermenters, making recovery of CO₂ possible.

In **lactic acid fermentation**, lactose or other sugars are converted into lactic acid and small amounts of other components. Lactic acid formation is accompanied by a decrease in pH, which is important for the taste, the aroma and the preservation of the product. There are several species of bacteria which are able to produce lactic acid. Each species gives its own typical taste and aroma. Lactic acid fermentation is an anaerobic process. It is sometimes necessary to remove as much of the oxygen as possible to enhance the fermentation process. Lactic acid fermentation is carried out at 20 to 40 °C.

To start the process, bacteria cultures known as starters are added to the raw material to be fermented. The preparation of starter cultures is a sensitive process since the risk of airborne infection must be reduced to an absolute minimum. Starter cultures must, therefore, be prepared in a separate room supplied with filtered air with a slight positive pressure compared to normal atmospheric pressure. The equipment cleaning system must also be carefully designed to prevent detergent and sterilant residues from coming into contact with the cultures and spoiling them. These very high hygiene constraints, coupled with the requirements of the temperature regulation, i.e. heat treatment of the substrate first and then cooling, require a specific energy consumption and use of cooling water.

2.1.4.5 Coagulation (D.5)

2.1.4.5.1 Objective

Coagulation is the agglomeration of suspended particles and separate solids from liquids or *vice versa*.

2.1.4.5.2 Field of application

Coagulation is used in cheese production and in the recovery of casein from milk. It is often used in milk processing to separate the curd from the whey and it is also called curdling.

2.1.4.5.3 Description of technique, methods and equipment

Temperature is one of the key factors that influence milk curdling. The required temperature is obtained by using either heat-exchangers or by direct injection of steam into the curdling vat. The temperature must be between 30 and 40 °C. Starters and other ingredients are added to the milk. These ingredients help determine the specific characteristics of the final product. Curdling is carried out in suitable vats or tanks, using either enzymatic coagulants, i.e. animal or microbial rennet or acidifying starters.

When enzymatic coagulants or acidifying starters are used, a casein jelly is formed which encloses the fat. The jelly will have different characteristics depending on which coagulant method is used. This is important for achieving the desired final production. The curd is produced by the separation of the whey, which is then gathered and sent for further processing as appropriate. To obtain further separation of the whey, e.g. to obtain a hard or semi-hard cheese, another heat treatment is given to the curd under stirring at up to 40 to 53 °C. For other kinds of cheese, such as mozzarella or provolone, as well as the curd being heated at a higher temperature, mechanical processing is also carried out to obtain the characteristic stretching/melting properties. Furthermore, organic acids are used to control the pH and to hold the curd at the right pH for the stretching properties to form.

2.1.4.6 Germination (D.6)

2.1.4.6.1 Objective

The objective of germination is to activate and develop the enzyme system in the grain kernel. This activated enzyme system is necessary to activate the starch and protein breakdown at the mashing stage before the later brewing process.

2.1.4.6.2 Field of application

Germination is an important processing step within the malting process of cereals. Malted cereals, mainly barley, are used for beer production and the production of distilled drinks, e.g. whisky. Malt is also used in food flavouring.

2.1.4.6.3 Description of processing techniques, methods and equipment

To start germination, the grain is steeped to obtain the necessary moisture content (see soaking, Section 2.1.4.1). The steeped grain is then transferred into germination vessels with perforated steel plate floors for pneumatic malting, or onto germination floors for floor malting. The grain is layered from about 70 to 150 cm thick for pneumatic malting and from about 5 to 15 cm for floor malting. The germination step generally lasts between 96 and 200 hours. Depending on the equipment, the process parameters, the raw material and the finished malt to be obtained, the germination process can be shorter or longer. Conditioned air, i.e. cooled or heated and humidified, is blown through the grain layer in pneumatic malting, or over it, in floor malting, to control the temperature and the moisture content during germination. To prevent the grain kernels from matting or felting, the layer of grain is turned from time to time, during which water spraying can also be applied. The germination process is stopped by drying.

2.1.4.7 Brining/curing and pickling (D.7)

2.1.4.7.1 Objective

Brining or curing is a process whereby a product is treated with common salt (NaCl) and curing salts which aims for the preservation of products by lowering the a_w below microbial tolerance limits. **Pickling** is the preservation of products by lowering the pH, especially for vegetables.

The objectives of these techniques are the long-life preservation of the control of the growth of spore forming micro-organisms, a decrease in the energy needed for heat treatment, and adding taste to the product.

2.1.4.7.2 Field of application

Brining or curing is applied in the production of certain types of cheese, meat, fish, vegetables and mushrooms. Salt levels in the product can range from 1 to 5 %. **Pickling** is applied in the fruit and vegetable sector.

2.1.4.7.3 Description of techniques, methods and equipment

In the **brining or curing** of meat products, the meat is treated with common salt (NaCl) and with one or more of the following curing salts: sodium nitrate (NaNO_3), sodium nitrite (NaNO_2), potassium nitrate (KNO_3) or potassium nitrite (KNO_2). The process is designed to produce an acceptable salt level in the product of about 1 – 3 %, or a level of curing salt sufficient to produce an acceptable cured meat colour, which is produced by reaction of the meat pigment myoglobin with nitrite. Nitrite may be used or it may be derived from nitrate, which is converted to nitrite in the curing system. The presence of salt and nitrite in the product inhibit microbial growth and enhance the durability and safety of the product. Thus, salt and nitrite are essential to the curing process.

Whereas the salt content is determined by consumer acceptability, the curing salt content is controlled by law. At present, a maximum of 100 mg/kg of nitrite and 250 mg/kg of nitrate, can be contained in the finished product. Other ingredients may be added to cured meats for a number of reasons, including taste. These include polyphosphates, sugars, spices, non-meat proteins and starches. Also certain types of cheese are brined for reasons of taste and preservation.

Several methods are applied for brining or curing, i.e. dry brining/curing, injection brining/curing, immersion brining/curing and tumble/massage brining/curing.

Dry brining/curing is applied to meat and cheese. In making cured meat products, salt and other curing ingredients are deposited on the surface of the meat and are absorbed by diffusion over a period of days or even weeks. At the same time liquor diffuses out of the meat, equivalent to about 10 % of the initial meat weight. In the production of certain types of cheese, e.g. cheddar, dry salt is added to the curd.

Injection brining/curing is used in meat processing, e.g. bacon and ham. A prepared solution, i.e. brine, containing the ingredients, is injected by needle(s) into the meat, either manually or by machine, to achieve a rapid deposition of curing salts and common salt throughout the mass. After injection, the meat may be further processed or sealed in a plastic vacuum bag for a number of days, or immersed in a brine that is identical or similar in composition to the injected brine.

Immersion brining/curing is applied to cheese, meat and vegetables. During immersion, salt gradually penetrates into the product while water containing soluble product components are extracted from the product. The immersion brine may be discarded after each usage or it may be continually restrengthened and re-used with only a bleed being discharged. Water extraction by brining can range from 5 to 15 % of the product weight. The salt content of the brine ranges from 5 to 20 %.

Tumble/massage brining/curing is especially applied to meat. In this process, the movement of brine into the meat is accelerated by mechanical action. The meat may be injected with the brine before treatment or it can rely on the mechanical action, possibly assisted by vacuum, to accelerate absorption of the brine. This process is normally used when the meat is to be subsequently cooked or canned.

Pickling of vegetables can be carried out by adding organic acids until the pH is below 4.3. In the process of making sauerkraut, salt is added (brining/curing) to promote the growth of lactic acid bacteria, for taste reasons and for conservation.

2.1.4.8 Smoking (D.8)

2.1.4.8.1 Objective

The aim of smoking is the preservation of food by exposure to smoke, which has a bacteriostatic effect. Preservation is also achieved by the drying of the surface layers and heat effects. In addition, smoking adds flavour and, in some cases, the smoking process is used to cook the food.

2.1.4.8.2 Field of application

Smoking is commonly used in the processing of fish, cheese, meat and meat products.

2.1.4.8.3 Description of techniques, methods and equipment

There are two types of smoking, hot smoking and cold smoking. These are described in Sections 4.2.5 – 4.2.5.5.

2.1.4.9 Hardening (D.9)

2.1.4.9.1 Objective

The objective of hardening is to increase the melting point of the product and to change the solid-fat content of edible oils into edible fats.

2.1.4.9.2 Field of application

Hardening is applied in the processing of edible oils for the production of margarine and other edible fats.

2.1.4.9.3 Description of techniques, methods and equipment

Hardening, or hydrogenation of oils, is the process of saturating mono or poly-unsaturated fatty acids by adding hydrogen gas (H_2) for the hydrogenation and nickel as a catalyst. Hydrogen molecules, in the presence of nickel and under special process conditions, saturate the unsaturated bonds of the fatty acids of edible oils. Neutral or bleached oil is heated to a temperature of 150 to 205 °C in the presence of a nickel catalyst, maximum 10 kg catalyst/tonne product. H_2 is then added to the mixing reactor to achieve the hardening, i.e. the transformation from oil to fat. Hydrogenation is an exothermic process. After the reaction, the fats are separated from the nickel, using filter presses or other filter systems. In a minority of cases, the nickel catalyst can be re-used several times until it is deactivated. Specialised companies recycle the spent nickel. The residual nickel concentration in the fats is removed by bleaching, which produces bleaching earth contaminated with nickel. The equipment used for hardening consists of mixing vessels, reaction tanks, autoclaves and filters.

2.1.4.10 Sulphitation (D.10)

2.1.4.10.1 Objective

The aim of sulphitation is to prevent either microbiological degradation, unwanted colour formation or to adjust pH.

2.1.4.10.2 Field of application

Sulphitation is applied in winemaking, potato processing and shellfish processing. It is also sometimes applied in sugar production to adjust the pH.

2.1.4.10.3 Description of techniques, methods and equipment

Sulphitation is the introduction of sulphur dioxide (SO_2) into liquids; the quantity of SO_2 which can be added is regulated. It can be introduced in various forms. First, in gaseous form, generated either by burning sulphur or from liquefied gas and direct expansion. The SO_2 is drawn by a fan into an absorption column in which the liquid flows. Second, in liquid form, from liquefied gas or in sodium or potassium bisulphite solution. The SO_2 may also be stored as a liquid, under approximately 5 bar, in horizontal cylindrical tanks of 25 to 50 m³ capacity, from which it can then be introduced into the desired process stream. Third, in solid form, as sodium or potassium metabisulphite dissolved in the liquid to be treated.

An alternative sulphite source is ammonium bisulphite. Sodium bisulphite can also be used.

2.1.4.11 Carbonatation (D.11)

2.1.4.11.1 Objective

The aim of carbonatation is to remove impurities from a solution.

2.1.4.11.2 Field of application

Applied in the sugar industry.

2.1.4.11.3 Description of techniques, methods and equipment

Carbonation is the introduction of the milk of lime, calcium hydroxide, and carbon dioxide gas (CO₂) into a liquid to form calcium carbonate and to precipitate and remove impurities. The effect of lime and CO₂ is the precipitation of insoluble calcium salts, the flocculation of colloidal components, the chemical degradation of other molecules such as invert sugar and amides, and the absorption of non-sugars on precipitated calcium carbonate. Lime and CO₂ are normally produced in lime kilns by the thermal dissociation of limestone.

Any non-sugar components contained in the raw sugar juice after extraction from the beet, make the subsequent stages in the sugar process impossible to perform. Therefore, the raw juice must be purified to allow further processing. This is achieved by continuously adding milk of lime and carbon dioxide from the lime kiln to precipitate most of the non-sugars. The product after filtration contains the calcium carbonate and the non-sugars and is used in agriculture as a liming material to improve the structure of arable soil and to regulate soil acidity. Sugar factory lime may also be used for site recovery, e.g. filling quarry ditches, and for producing bricks or cement. For aspects relating to lime kilns, see the “Cement and lime BREF” [219, EC, 2001].

2.1.4.12 Carbonation (D.12)

2.1.4.12.1 Objective

The aim of this process is to dissolve a quantity of carbonic gas into different products to obtain a gasified or carbonated final product. When dissolved in water, carbon dioxide (CO₂), is sparingly soluble and thus, slowly released, forming bubbles that provide a characteristic mouthfeel and a unique taste when consumed. In addition to an organoleptic property, under suitable conditions, CO₂ has a preserving property by the inhibition of the development of harmful aerobic micro-organisms. This, however, is not a substitute for other methods used to ensure microbiological safety.

2.1.4.12.2 Field of application

Carbonation is an important process step in the preparation of many soft drinks and certain types of mineral waters. It is also applied in the wine and brewing industries. In the manufacture of still wines, carbonation is used to protect the colour and increase the aroma.

2.1.4.12.3 Description of techniques, methods and equipment

Carbonation results from the impregnation of a liquid with CO₂ to form carbonic acid. The CO₂ was traditionally obtained from lime kilns, by heating calcium carbonate, but this has now been universally replaced in the soft drinks sector by the storage of bulk liquefied gas externally delivered by a CO₂ supplier. The gas is stored within pressurised insulated tanks kept at a very low temperature. In common practice, the gas tends to be generated as a by-product of fermentation or chemical processes from companies outside of the soft drinks sector.

A carbonator combines CO₂ gas with the liquid to be carbonated. Current carbonators can be classified into two main categories; those that carbonate water only and those that carbonate the finished product mixture of syrup and water. These are sometimes coupled with coolers, often referred to as carbo-coolers. The principal designs available are carbonators with integral coolers, draining wall heat-exchangers and carbon dioxide injectors.

In combination with this process, de-aeration, i.e. the removal of air, is vital and is usually applied to the water component in a first stage. The presence of air can create spoilage problems. CO₂ is sometimes used to flush out air, however, the use of mechanically de-aerated water has become more popular in recent years.

The degree of carbonation varies for each soft drink formulation, from 4 g/l in fruit drinks to 9 g/l in mixer drinks and 12 g/l in soda water. The CO₂ gas content is one of the smallest constituents by weight, but possibly the most important, in regard to palatability of the product. CO₂ is one of the very few gases suitable for providing the effervescence in soft drinks; it is non-toxic, inert, and virtually tasteless and allows for convenient bulk transportation and storage.

2.1.4.13 Coating/spraying/enrobing/agglomeration/encapsulation (D.13)

2.1.4.13.1 Objective

The aim of this group of operations is to cover a food product with a layer of material to improve the eating quality, to provide a barrier to the movement of moisture and gases, or as protection against mechanical damage.

2.1.4.13.2 Field of application

Coating, by one of the above-mentioned techniques, is applied to confectionery, ice-cream, baked goods, snack foods, fish, poultry and potato products.

2.1.4.13.3 Description of techniques, methods and equipment

Confectionery, ice-cream and baked goods are often coated with chocolate or compound coatings containing chocolate. The principal ingredients in such coatings are fat and sugar. The fat is tempered and held at a temperature of 31 to 32 °C, resulting in a liquid coating mass. This coating is applied to the food products in the form of a single or double curtain through which the food is passed on a stainless steel wire conveyor. A pan beneath the conveyor collects the excess coating, which is then recirculated through a heater to the enrobing curtain. Products like fish, poultry and potato products are often coated with batters. A suspension of flour in water to which sugar, salt, thickening agents, flavourings and colourings are added to achieve the required characteristics of the batter. The product is passed through the batter between two submerged mesh conveyors. Coating with breadcrumbs can take place by depositing food products onto a moving bed of breadcrumbs and then passing the bed through a curtain of breadcrumbs. Other methods for coating are spraying the coating material onto the product, agglomeration of products and encapsulation of the food particles.

2.1.4.14 Ageing (D.14)

2.1.4.14.1 Objective

The aim of this process is to mature the product, especially for products aged in wooden casks that allow some gas exchange between the product contained in the cask and the environment. It is also part of the legal requirements when manufacturing some products.

2.1.4.14.2 Field of application

Ageing is commonly applied to wine and brown spirits.

2.1.4.14.3 Description of techniques, methods and equipment

Ageing consists of filling wooden vessels, usually oak barrels, and then storing these vessels at a moderate temperature during a period of time according to the product needs and the regulatory requirements for this product. The capacity of oak barrels is between 200 and 600 litres.

2.1.5 Heat processing (E)

2.1.5.1 Melting (E.1)

2.1.5.1.1 Objective

The objective of melting is to obtain a phase change from solid to liquid, to prepare the material for further processing, e.g. for fats and processed cheese, or to recover the melted fraction, i.e. in fat recovery.

2.1.5.1.2 Field of application

The main applications of melting in the FDM sector are in chocolate moulding, the production of processed cheese, the processing of oils and fats and the recovery of animal fat from meat residues.

2.1.5.1.3 Description of techniques, methods and equipment

For melting, processing kettles are used. These can be operated either batch wise or continuously. Heating may be carried out by direct steam injection or indirectly by steam jackets. Processing kettles are available in various sizes and shapes. In continuous processing, scraped surface heat-exchangers are applied.

2.1.5.2 Blanching (E.2)

2.1.5.2.1 Objective

Blanching is designed to expose the entire product to high temperatures for a short period of time. The primary function of this operation is to inactivate or retard bacterial and enzyme action, which could otherwise cause rapid degeneration of quality. Two other desirable effects of blanching include the expelling of air and gases in the product, and a reduction in the product volume.

2.1.5.2.2 Field of application

Blanching is an important step in the processing of fruit and green vegetables.

2.1.5.2.3 Description of techniques, methods and equipment

Before blanching, the food is preheated. Blanching may be accomplished by direct or indirect heating systems. This may depend on the product. Direct heating is normally made by immersion into hot water, at 80 to 100 °C, or by exposure to live steam. The operation is normally carried out in horizontal chambers. The residence time in the blancher can vary from approximately 1 to 5 minutes depending on the fruit or vegetable being blanched. For some products, direct contact with water is to be avoided so heat-exchangers working with hot water or vapour are applied. Indirect heating is described in Section 2.1.5.8. After blanching, the food is cooled using either water or air.

2.1.5.3 Cooking and boiling (E.3)

2.1.5.3.1 Objective

Cooking and boiling are heat processing techniques applied to foodstuffs, principally to make the food edible. They also alter the texture, colour and moisture content of the food and may facilitate other later processes.

2.1.5.3.2 Field of application

Cooking and boiling are applied on an industrial scale for the preparation of ready-to-eat meals, in the preparation of complete meals and for meal components, such as in various meat products. They are also applied to heat foodstuffs prior to final processing.

2.1.5.3.3 Description of techniques, methods and equipment

In this document, cooking is distinguished from roasting, which is described in Section 2.1.5.5. **Cooking** is carried out in ovens. There are several different types of ovens; water bath, shower, steam, hot air and microwave.

Water bath ovens allow the best homogeneity of heating to be obtained. The immersion into hot water causes weight loss, and results in proteins and greases being released into the water. **Boiling** is cooking in a water bath oven at boiling temperature.

Shower ovens allow a good uniformity of heating. They include the simultaneous action of water sent through the showers and the saturated steam which rises from the collecting basin, at the bottom of the oven, which is heated, in turn, by coils.

In steam ovens, the water shower is eliminated and any heating is only due to the steam produced in the collection basin.

Hot air ovens include, when it is necessary to control surface humidity, a steam inlet and a recirculation of hot air which is obtained by passage through heat-exchangers.

In a microwave oven, food is heated by passing microwaves through it, the resulting generation of heat inside the food facilitates rapid cooking.

2.1.5.4 Baking (E.4)

2.1.5.4.1 Objective

Baking is a heat processing technique, principally to make the food edible. It can also change the taste and texture. Another objective of baking is to preserve the food by destruction of the micro-organisms and reduction in the a_w at the surface of the food. However, the shelf-life of most baked foods is limited, unless products are refrigerated or packaged.

2.1.5.4.2 Field of application

Baking is used to prepare ready-to-eat products such as bread, cakes and biscuits. Baking can be applied to fruit and vegetables. Baked vegetables may be used as a filling or as a topping component in many food products such as pies, pizzas and snack foods.

2.1.5.4.3 Description of techniques, methods and equipment

In a baking oven, the food is exposed to hot air at 110 to 240 °C, or to infrared irradiation. The moisture at the surface is evaporated and removed by the hot air. When the rate of moisture loss at the surface exceeds the rate of transport of moisture from the interior of the product to the surface, the surface dries out and a crust is formed.

It is a common problem with filled food products that the moisture content of the filling component, commonly fresh vegetables, adversely affects the casing or base component of the food product during storage, via moisture migration into the casing or base. The alternative of conventional dehydrated vegetables is not suitable, since these have undesirable taste and texture properties and require rehydration prior to use. Baked vegetables do not have these drawbacks. Suitable vegetables for this process include courgettes, peppers, mushrooms, potatoes, cauliflowers, onions, artichokes and aubergines.

There are four types of ovens; direct heating, indirect heating, electric and infrared ovens. All oven types can be batch or continuous in operation. In batch ovens, the walls and the base are heated. In continuous ovens, radiators are located above, alongside and below the conveyor belt. Batch ovens incur higher labour costs than continuous ovens. Another disadvantage can be the non-uniformity in baking times, caused by the delay in loading and unloading the oven.

In direct heating ovens, air and combustion gases are recirculated by natural convection or by fans around the product to be baked. The temperature in the oven is controlled by adjusting the air and fuel flowrates to the burner. The fuels normally used are natural gas, propane and butane. The gas is burned in ribbon burners above or sometimes below the conveyor belt and product. The advantages of direct heating ovens are their short baking times, high thermal efficiencies, rapid start-up and good temperature control. Good management and care is necessary to prevent contamination of the food by undesirable products of combustion.

In indirect heating ovens, the air in the baking chamber is heated via a heat-exchanger, by steam or by burning a fuel. The air in the baking chamber is typically recirculated through the baking chamber and the heat-exchanger. Other methods include passing the combustion gases through radiator tubes in the baking chamber, or burning the fuel between a double wall whilst exhausting the combustion gases from the top of the oven.

Electric ovens are heated by induction, heating radiator plates or bars.

In infrared ovens for baking vegetables, the raw material is washed and sliced or diced. The vegetable pieces are then flash blanched for 60 to 80 seconds, in 100 % saturated steam in a jet stream oven at 200 to 300 °C. The steam is delivered to the oven at a rate of approximately 500 to 540 kg/h. The air speed in the oven is 17 – 25 m/s. The product is transferred next into a second jet stream where it is steam cooked at 270 to 300 °C in 50 % saturated steam for 65 to 85 seconds, without changing the steam and air speed conditions. The product is then transferred to an oven for infrared baking for 3.5 to 5 minutes. The air temperature in the oven increases from 240 to 350 °C as the product travels through the oven on a conveyor belt. In this process, the vegetables lose approximately 30 to 60 % of their water content, depending on the vegetable.

2.1.5.5 Roasting (E.5)

2.1.5.5.1 Objective

The aim of the process is to cook the food to make it edible, to produce dry products and/or to enhance the structure of raw products.

2.1.5.5.2 Field of application

Typical ingredients that are roasted are coffee, nuts, cacao, chicory, fruit, cereals and pre-processed cereals.

2.1.5.5.3 Description of techniques, methods and equipment

The raw product is usually exposed to hot air at temperatures of over 100 °C. Sometimes the raw product is pre-dried. If so, first the water is evaporated from the product to decrease the moisture content of 8 to 20 % to less than 1 %. If the product reaches a sufficiently high temperature, i.e. over 120 °C, reactions take place in the product. These so-called Maillard reactions are important in the formation of aromas in coffee and cacao. The duration of this roasting process depends on the product and the specific aromas that are required. Roasting times for coffee range between 1 and 20 minutes, while for cacao and other products this can be up to 180 minutes. When the product temperature reaches the required level, the Maillard reactions are stopped by either cooling the product with air or by quenching the product with water followed by cooling with air.

Roasting can be carried out either batch wise or continuously. Typical equipment for batch roasting are a drum roaster, a column roaster, a rotating disc roaster, a fluidised bed roaster and a spouting bed roaster. Common to all equipment is that the product is heated and agitated at the same time. The product can be in direct contact with the hot air, called convective heat transfer, or in contact with a heated surface, called conductive heat transfer. Usually it is a combination of both. The cooling takes place in separate equipment. This can be a cooling sieve where air is pulled through or a spouting bed cooler or any other equipment where the raw product is in contact with fresh air. Quenching with water can take place in the roasting chamber and sometimes in the cooling equipment. Cyclones are used as an integral part of the process to remove dust, mainly consisting of product residues and skins (chaff) before it is exhausted to the air. The recovered material is then reprocessed. The cooling air is also emitted to the air.

2.1.5.6 Frying (E.6)

2.1.5.6.1 Objective

The objective of frying is to cook in edible oil at temperatures in the region of 200 °C. Vegetable oil, or a mixture of animal fat and vegetable oil, is normally used.

2.1.5.6.2 Field of application

Raw materials such as fish, potatoes and chicken can be fried, e.g. in the production of products such as fish fingers, potato chips and chicken nuggets.

2.1.5.6.3 Description of techniques, methods and equipment

The product is fed into the fryer on a slatted belt. The fryer is a horizontal chamber containing the oil. The product drops into the oil and if it is coated in batter, this expands and brings the product to the surface of the oil. The slatted belt feeds the product under the main fryer belt, which takes the product through the fryer and controls the frying time. The take-out belt at the end of the fryer lifts the product out of the oil, allows drainage and transfers the product to the inspection and packing belts. Fryers are equipped with a fume extraction fan to eliminate fume leakage. The frying temperature and time vary according to the product being processed. Temperatures range from 190 to 205 °C and residence times in the fryer are normally around 35 seconds, but can be as long as 6 minutes.

2.1.5.7 Tempering (E.7)

2.1.5.7.1 Objective

The objectives of tempering are to ensure product quality and appearance, enable handling of liquid chocolate for various applications, e.g. demoulding, and ensure viscosity control and enable net weight requirements to be met. Tempering is also the controlled thawing of meats.

2.1.5.7.2 Field of application

Tempering is applied in the manufacture of chocolate and products containing chocolate. Chocolate formulations containing cocoa butter, or cocoa butter equivalents, need to be tempered before use. Chocolate may be under-tempered, well-tempered or over-tempered depending on the particular application.

Tempering is done because cocoa butter can exist in various crystalline forms, which if left untempered transform into unstable forms that impact severely on production capability and product quality. The process ensures that the fat is crystallised into stable forms which then enables products to be manufactured with good gloss and hardness, and to be crispy if needed. It also delays the formation of grey white spots on the surface known as fat bloom.

2.1.5.7.3 Description of techniques, methods and equipment

The tempering process involves the melting of all the fat crystals present by heating to at least 40 °C or above, then cooling the mass to typically below 30 °C, known as the seeding temperature. This allows formation of stable crystalline forms, which, on holding, enables a further desirable transformation to occur. Finally the mass is warmed slightly to melt out any remaining unstable crystalline forms and to establish further crystallisation of the stable forms. Depending on the particular recipe or formulation, temperatures and holding times will vary accordingly to ensure the optimum product quality.

Single stream tempering uses the standard technique of inducing crystallisation of the stable forms from liquid followed by changes in temperature. The product is carried by a conveyor screw feed into a tempering tube where it is tempered in three stages.

Twin stream tempering requires an already seeded stream to be introduced into a molten untempered chocolate stream.

Finally, multistage tempering is based on gentle cooling to produce seed crystals, followed by gentle reheating to allow the formation of stable crystalline forms. The cooling and reheating zones are made up of multistages maintained at the required temperature ranges via a jacketed recirculating water system. Various tempering machines are available based on this principle and are widely used in industry for a wide range of applications.

2.1.5.8 Pasteurisation, sterilisation and UHT (E.8)

2.1.5.8.1 Objective

The conservation of food and feed products is achieved by the killing of the micro-organisms present. Heat treatment for the conservation of products is one of the main techniques used in the FDM sector. Heat treatment stops bacterial and enzyme activity and so prevents loss of quality and reduces food perishability. In heat treatment processes, various time/temperature combinations can be applied, depending on the product properties and shelf-life requirements.

Pasteurisation is a controlled heating process used to eliminate viable forms of any micro-organism, i.e. pathogen or spoilage causing, that may be present in milk, fruit-based drinks, some meat products, and other foods, or to extend shelf-life as is the case with beer. A similar controlled heating process, referred to as blanching, is used in the processing of fruits and vegetables. Both pasteurisation and blanching are based on the use of the minimum heat requirement needed to deactivate specific micro-organisms or enzymes, thus minimising any quality changes in the foods themselves [87, Ullmann, 2001]. In pasteurisation, generally a heating temperature below 100 °C is applied.

Sterilisation is a controlled heating process used to eliminate viable forms and spores of any micro-organism, i.e. pathogen or spoilage causing, that may be present in a preserved food. This can be achieved by moist heat, dry heat, filtration, irradiation, or by chemical methods. Compared to pasteurisation, a heat treatment of over 100 °C is applied for a period long enough to lead to a stable product shelf-life.

UHT is a heat treatment of over 100 °C for a very short time.

2.1.5.8.2 Field of application

Pasteurisation and **sterilisation** are used to treat all types of FDM products; these include milk, juices and beer. **UHT** is applicable to low viscosity liquid products.

2.1.5.8.3 Description of techniques, methods and equipment

Pasteurisation temperatures commonly range from 62 to 90 °C, and pasteurisation times vary from seconds to minutes. Batch wise pasteurisation uses a temperature of 62 to 65 °C for up to 30 minutes. High temperature short time (HTST) pasteurisation uses a temperature of 72 to 75 °C for 15 to 240 seconds. High heat short time pasteurisation (HHST) applies a temperature of 85 to 90 °C for 1 to 25 seconds.

Batch wise pasteurisation is carried out in agitated vessels. Sometimes the product, i.e. beer and fruit juices, is pasteurised after bottling or canning. Here the products in their containers are immersed in hot water or fed through a steam tunnel. For continuous pasteurisation, flow-through heat-exchangers, e.g. tubular, plate and frame, are applied. These have heating, holding and cooling sections. Table 2.2 shows examples of heat treatment combinations used in the FDM sector.

Process	Heating temperature/ holding time	Use
Bulk liquid pasteurisation	63 °C/30 min	Vat pasteurisation of milk
High temperature short time pasteurisation (HTST)	72 °C/15 s	Continuous pasteurisation of milk for food safety
Cooking of meat products	65 to 75 °C internal temperature	Ready-to-eat products, e.g. ham, meat loaves and frankfurters
Blanching of vegetables	Variable, e.g. 75 °C/5 min	Enzyme deactivation and tissue softening
In-bottle pasteurisation	60 °C/10 min*	Shelf-life extension of beer
*the parameter may vary depending on the type of beer		

Table 2.2: Examples of heat treatment combinations used in the FDM sector [1, CIAA, 2002]

Generally for **sterilisation**, the product is canned or bottled and then heat-treated in a steriliser with steam or hot water. Sterilisers may be batch or continuous. In sterilisation with moist heat, temperatures generally range from 110 to 130 °C with sterilisation times being from 20 to 40 minutes. For example, canned foods are sterilised in an autoclave at about 121 °C for 20 min. Higher temperatures and shorter times may have similar effects, e.g. 134 °C for 3 min. However, if conditions do not allow the germination of spores, lower temperatures and shorter times can also be applied. For example, with acid fruit juices, jam, or desserts, heating up to 80 to 100 °C for 10 minutes is normally sufficient.

For killing bacterial endospores by dry heat, longer exposure times and higher temperatures are required than with moist heat, e.g. up to 2 hours at 160 to 180 °C. Solutions containing thermolabile compounds can be sterilised by filtration through mediums such as nitrocellulose membranes, diatomaceous earth, e.g. kieselguhr, and porcelain. UV irradiation is used to keep rooms partially sterile. Bacteria and their spores are killed quickly, but fungal spores are only moderately sensitive to radiation. Ionising radiation, e.g. X-ray and gamma radiation, is used to sterilise food and other compact materials. Chemical means may also be applied. Ethylene oxide is used to sterilise food, plastics, glassware, and other equipment [87, Ullmann, 2001].

UHT treatment means a very short heat treatment at temperatures of 135 to 150 °C for only a few seconds. This results in a sterilised product with minimal heat damage to the product properties. UHT treatment is only possible in flow-through equipment. The product is thus sterilised before it is transferred to pre-sterilised containers in a sterile atmosphere. This requires aseptic processing. For UHT treatment, indirect heating in plate and frame or tubular heat-exchangers is applied. Direct steam injection or steam infusion may also be applied.

2.1.6 Concentration by heat (F)

2.1.6.1 Evaporation (liquid to liquid) (F.1)

2.1.6.1.1 Objective

Evaporation is the partial removal of water from liquid food by boiling. For instance, liquid products can be concentrated from 5 % dry solids to 72 %, or even higher, depending on the viscosity of the concentrates. Evaporation is used to pre-concentrate food, to increase the solid content of food, to change the colour of food and to reduce the water content of a liquid product almost completely, e.g. as in edible oil drying.

2.1.6.1.2 Field of application

Evaporation is used in many FDM sectors. For example, it is used to process milk, starch derivatives, coffee, fruit juices, vegetable pastes and concentrates, seasonings, sauces, sugar and edible oil.

2.1.6.1.3 Description of techniques, methods and equipment

Steam, vapour, or exhaust gases from other drying operations, are usually used as the heating medium. The latent heat of condensation is transferred to the liquid food to raise its temperature to boiling point, to evaporate the water. The vapour is then removed from the surface of the boiling liquid. Since food products are heat sensitive, it is often necessary to work at low temperatures. This is achieved by boiling the liquid part under vacuum. Evaporation normally occurs in the range of 50 to 100 °C, although it can be as high as 130 °C in the sugar industry.

In its simplest form, evaporation is carried out by boiling off water to the air, using immersed electric heaters. However, in practice the most commonly used equipment is multistage shell and tube evaporators, or plate evaporators. Shell and tube evaporators may be natural or forced circulation, climbing or falling film types. Centritherm evaporators, wiped film evaporators (WFE), thin film evaporators and vacuum pans are specially designed for the evaporation of highly viscous products. Typical total solids concentrations for various types of evaporators are shown in Table 2.3. The level of total solids in the outlet depends on the composition of the product to be concentrated.

Evaporator type	Total solids inlet (%)	Total solids outlet (%)
Shell and tubes, multistage	5 – 25	40 – 75
Plates, multistage	5 – 25	40 – 75
Vacuum pans	60 – 70	80 – 85
Centritherm, single-stage	5 – 25	40 – 60
WFE, single-stage	40 – 50	70 – 90

Table 2.3: Typical total solids concentrations for various types of evaporators [1, CIAA, 2002]

Multiple-effect evaporators are used when evaporation requires significant energy, e.g. in sugar beet processing, starch production and the evaporation of milk and whey. These evaporators use fresh steam or exhaust gases from other operations, and so recover or re-use energy, to boil off water vapour from the liquid in the first effect. The evaporated water still has sufficient energy to be the heat source for the next effect, and so on. A vacuum is applied in a multiple-effect series to allow the water to boil off. The liquid being processed is passed from one evaporator body through the others so it is subjected to multiple stages of evaporation. In this way, one unit of steam injected in the first evaporator can remove three to six units of water from the liquid.

Additional energy can be saved by recompressing the vapour using a thermal vapour recompressor (TVR) or a mechanical vapour recompressor (MVR). However, this can lead to steam contamination, making it unsuitable for return to the boilers and, therefore, increasing the waste water load. In the final stage, the vapour may be condensed by cooling with cooling water. Some of the vapours can be drawn off the evaporators to be used as heat sources for other process requirements. The condensate may be of such a quality that it may even be fed to other processes as process water.

During processing, product compounds gradually deposit on the heat-exchange surfaces. This can affect the efficiency of the heat-exchange and lead to heat losses in the system. These deposits may be inorganic or organic, depending on the product. The installation must, therefore, be cleaned at regular intervals to prevent too high a heat loss occurring with a subsequent loss of product quality.

2.1.6.2 Drying (liquid to solid) (F.2)

2.1.6.2.1 Objective

Drying is defined as the application of heat under controlled conditions to remove the water present in liquid foods by evaporation to yield solid products. It differs from evaporation, which yields concentrated liquid products. The main purpose of drying is to extend the shelf-life of foods by reducing their a_w .

2.1.6.2.2 Field of application

Typical applications for drying techniques include dairy products, e.g. milk, whey and creamers, coffee, coffee surrogates, tea, flavours, powdered drinks, and processed cereal-based foods.

2.1.6.2.3 Description of techniques, methods and equipment

Two different principles can be applied for drying; hot air drying and surface drying by heat conduction through a heat transfer system.

In hot air drying, hot air is used as the heating medium and is in direct or indirect contact with the liquid product. The heat transferred from the hot air to the product causes evaporation of the water content.

In surface drying by heat conduction through a heat transfer system, the heating medium is not in contact with wet food but separated from it by a heat transfer surface. The heat is transferred by conduction through the surface, and by convection from the hot surface to the food product for evaporating and removing water from the food. This has two main advantages compared to hot air driers; less air volume is required and, therefore, thermal efficiency is higher, and the process may be carried out in the absence of oxygen.

The driers used are spray, roller, and vacuum band and vacuum shelf driers.

In spray drying, the material to be dried is suspended in air, i.e. the liquid is converted into a fog-like mist or atomised liquid, providing a large surface area. The atomised liquid is exposed to a flow of hot air in a drying chamber. The moisture evaporates quickly and the solids are recovered as a powder consisting of fine, hollow, spherical particles. Air inlet temperatures of up to about 250 °C or even higher, depending on the type of product, are used, but due to evaporation, the air temperature drops very rapidly to a temperature of about 95 °C, which is the outlet temperature of the air. The product temperature is 20 to 30 °C below the air outlet temperature. Heating the drying air can be accomplished by steam or by direct gas-fired air heaters or by indirect heaters fired by gas, liquid or solid fuels. Spray drying is applied on a large scale in the dairy industry and for drying coffee.

Generally, as an integral part of the process, the exhaust air is passed through cyclones and/or filters to recover particulate materials or dust which are carried over in the exhaust air. The recovered material is incorporated back into the product.

The principle of roller drying is that a thin film of material is applied to the smooth surface of a continuously rotating, steam-heated metal drum. The film of the dried material is continuously scraped off by a stationary knife located opposite the point of application of the liquid material. The drier consists of a single drum or a pair of drums with or without satellite rollers. The applied steam pressure in the drums can vary from 4 to 8 bar, depending on the product. Roller drying is applied, e.g. for milk, starch and potato flakes.

Finally, in vacuum band and vacuum shelf driers, food slurry is spread or sprayed onto a steel belt, which passes over two hollow drums within a vacuum chamber. The food is first dried by the steam-heated drum, and then by the steam-heated coils or radiant heaters located over the belt. The dried food is cooled by the second water-cooled drum and removed by a doctor blade. The rapid drying and limited heat damage to the food makes this method suitable for heat-sensitive foods.

2.1.6.3 Dehydration (solid to solid) (F.3)

2.1.6.3.1 Objective

Dehydration is defined as the application of heat under controlled conditions to remove, by evaporation, the water present in solid foods or by-products from agricultural raw material processing. The main purpose of dehydration is to extend the shelf-life of foods by reducing their a_w .

2.1.6.3.2 Field of application

Some examples of dried foods are dried potatoes, starch derivatives, sugar beet pulp, flour, pasta, beans, fruit, nuts, cereals, meal of oilseeds, tea leaves, vegetables and spices. The dehydration of wet germinated grain is applied in the production of malt which is also called kilning. For the malting process, the drying step is essential and is required to create the desired colour and flavour.

2.1.6.3.3 Description of techniques, methods and equipment

Dehydration affects food texture and colour, and causes the loss of volatile components, all of which have a detrimental effect on both the quality and the nutritional value of the food. The design and operation of dehydration equipment aims to minimise these changes by selecting appropriate drying conditions for individual foods. For dehydration, the two different principles are, i.e. hot air drying and surface drying by heat conduction through a heat transfer system. These are explained in detail in Section 2.1.6.2.

Various types of driers are used, i.e. fluidised, cabinet or tray, conveyor or belt, pneumatic, flash and/or ring, rotary, tunnel, steam bundle, steam, kiln and vacuum driers.

FBDs are composed of metal trays with mesh or perforated bases that can contain a bed of particulate foods up to 15 cm deep. Hot air is blown through the bed, causing the food to become suspended and then vigorously agitated. The air acts as both the drying and the fluidising medium. They can be batch or continuously operated. FBDs are compact and allow a good control over the drying conditions and relatively high thermal efficiencies and high drying rates. These driers have very high rates of heat and mass transfer and consequently short drying times. Drying can take place with air temperatures below 100 °C, but may also be up to 170 °C or higher depending on the product/process. FBD is often applied as a last drying step after spray drying (see Section 2.1.6.2), in the dairy industry.

Cabinet or tray driers consist of an insulated cabinet fitted with a shallow mesh or perforated trays, each of which contains a thin layer of food. Hot air is circulated through the cabinet. A system of ducts and baffles are used to direct air over and/or through each tray to promote a uniform air distribution. These driers are used for small scale production and have low capital and maintenance costs. They are relatively difficult to control and produce variable product quality.

Continuous conveyor or belt driers are up to 20 metres long and 3 metres wide. The food is dried on a mesh belt. The airflow is initially directed upwards through the bed of food and then downwards in later stages to prevent dried food from blowing out of the bed.

In pneumatic, flash and/or ring driers, powders or particulate foods are continuously dried in vertical or horizontal metal ducts. A cyclone separator or a bag filter is used to remove the dried product. The moist food is metered into the ducting and suspended in hot air. They have relatively low capital costs, high drying rates and thermal efficiencies, and good control over the drying conditions.

Rotary driers are slightly inclined rotating metal cylinders fitted internally with flights that cause the food to cascade through a stream of hot air as it moves through the drier. Airflow may be parallel or countercurrent. The agitation of the food and the large area of food exposed to the air produces high drying rates and a uniformly dried product. The method is especially suitable for foods that tend to mat or stick together in belt or tray driers. It is used on a large scale in the sugar industry for sugar and beet pulp drying. In the case of pulp, exhaust gases from the combustion plant may be used as a heat source when the physical plant and the flue-gas temperature allows. Some combustion plants can produce flue-gas temperatures of around 120 °C.

In tunnel driers, thin layers of food are dried on trays, which are stacked on trucks programmed to move semi-continuously through an insulated tunnel in which hot air is circulated.

In steam bundle driers, the heating medium or steam is not in contact with the wet product. A heat transfer surface is used to transfer the heat to the product's surface for drying. The steam passes through the drier, through cylindrical tubes/bundles which rotate, to avoid local overheating and to improve uniform drying. This drier uses less air volume and subsequently emissions into the air are limited.

Steam drying is a special drier design that uses superheated steam produced via a heat-exchanger. The drier consists of a pressure vessel in which the water from the product is driven off, turned into steam and then used to dry more product. This system is used in the sugar industry, on a limited scale, for drying beet pulp. One advantage is the low energy consumption for drying.

Drying in kilns is used for malting and is described in Section 2.2.15.

Vacuum drying is used for temperature sensitive products. The external pressure is lowered to avoid drying at a high temperature. One simple type of vacuum drying is vacuum roller drying. In this method, either one or two rollers are installed in a vacuum housing. The resulting vapour precipitates in a condenser located between the vacuum chamber and the pump. The product is removed by a screw conveyor.

2.1.7 Processing by the removal of heat (G)

2.1.7.1 Cooling, chilling and cold stabilisation (G.1)

2.1.7.1.1 Objective

Cooling is used to reduce the temperature of the food from one processing temperature to another or to a required storage temperature. Chilling is a processing technique in which the temperature of a food is reduced and kept at a temperature between -1 and 8 °C. The objective of cooling and chilling is to reduce the rate of biochemical and microbiological changes in foods, to extend the shelf-life of fresh and processed foods, or to maintain a certain temperature in a food process, e.g. in the fermentation and treatment of beer. Cooling is also used to promote a change of state of aggregation, e.g. crystallisation. The objective of cold stabilisation is to precipitate out tartrates in wines, or fatty acids in spirits before bottling.

2.1.7.1.2 Field of application

Cooling, chilling and cold stabilisation are widely used in the FDM sector.

Chilling is used for preservation of a lot of perishable foods. In the wine sector, cooling and chilling are applied to clarify the must before fermentation. Cold stabilisation is used in the beer, wine and spirit sectors. Beer is cold stabilised to precipitate the protein-polyphenol adduct. The beer is kept between -2 and -3 °C for at least 12 hours.

2.1.7.1.3 Description of techniques, methods and equipment

Cooling of liquid foods is commonly carried out by passing the product through a heat-exchanger or cooler or by cooling the vessels. The cooling medium in the cooler can be groundwater, water recirculating over a cooling tower, or water, eventually mixed with agents like glycol, which is recirculated via a mechanical refrigeration system or ice-water system.

In cryogenic cooling, the food is in direct contact with the refrigerant, which may be solid or liquid carbon dioxide, or liquid nitrogen. As the refrigerant evaporates or sublimates, it removes heat from the food, thereby causing rapid cooling. Both liquid nitrogen and carbon dioxide refrigerants are colourless, odourless and inert.

The supply of **chilled** foods to consumers requires a sophisticated distribution system, involving chilled stores, refrigerated transport and chilled retail display cabinets. Chilled foods can be grouped into three categories according to the storage temperature [225, Hendley B., 1985]. A fourth category is applied to winemaking.

- -1 to 1 °C for fresh fish, meats, sausages and ground meats, smoked meats and fish
- 0 to 5 °C for pasteurised canned meat, milk and milk products, prepared salads, baked goods, pizzas, unbaked dough and pastry
- 0 to 8 °C for fully cooked meats and fish pies, cooked or uncooked cured meats, butter, margarine, cheese and soft fruits
- 8 to 12 °C for the wine industry. The must is kept at this temperature for 6 to 24 hours.

The equipment used for freezing (see Section 2.1.7.2) can also be used for **cooling and chilling**.

Cold stabilisation is a technique for chilling wines before bottling to cause the precipitation of tartrate crystals. For spirits, this technique consists of bringing the spirit to a temperature of between -1 and -7 °C, depending on the operators, and possibly performing a stabulation, i.e. storing at low temperature, in tanks at constant temperatures for between 24 and 48 hours. A cold filtration, around -1 °C, allows the fatty acid esters to be retained. For wines, three techniques can be employed; cold stabilisation by batch and stabulation, continuous cold stabilisation, and cold stabilisation by crystal seeding. The two last techniques are the most widely-used. There can be many variations on these basic schemes.

Cold stabilisation by batch and stabulation is the oldest technique. It consists of bringing the wine to a temperature below zero close to freezing point and then stabulating it in an isothermal tank for a period of five to eight days.

$$\text{Freezing point (}^{\circ}\text{C)} = - (\text{alcohol (\% v/v)}/2) + 1$$

In continuous cold stabilisation, the stabulation tank is replaced by a cylindro-conical crystalliser and an agitator, in which the wine will remain for only 30 to 90 minutes.

Cold stabilisation is carried out by crystal seeding, consisting of refrigerating at between -1 and -2 °C, and seeding at 4 g/l of tartaric crystals with agitation over 2 to 4 hours, and later storage in tanks, followed by decantation after 12 to 48 hours.

2.1.7.2 Freezing (G.2)

2.1.7.2.1 Objective

Freezing is a preservation method. In freezing, the temperature of a food is reduced to below the freezing point and a proportion of the water undergoes a change in state to form ice crystals. The sector standard for freezing food is to reduce the temperature to around -18 °C.

2.1.7.2.2 Field of application

Several types of food can be frozen, e.g. fruits, vegetables, fish, meat, baked goods and prepared foods such as ice-cream and pizzas.

2.1.7.2.3 Description of techniques, methods and equipment

During freezing, the heat is first removed to lower the temperature of the food to the freezing point. This includes removal of heat produced by respiration as in fresh foods. The latent heat of crystallisation is then removed and ice crystals are formed. Table 2.4 shows the typical freezing points of various FDM products.

FDM product	Freezing point
Meat, poultry, and fish	-0.6 to -2.0 °C
Vegetables, e.g. peas, cauliflowers, onions, carrots and tomatoes	-0.9 to -1.4 °C
Fruits, e.g. pears, plums and apricots	-1.8 to -2.5 °C
Berry fruits, e.g. strawberries and raspberries	-0.8 to -1.2 °C
Milk	-0.5 °C
Ice-cream	-4.0 to -6.0 °C

Table 2.4: Typical freezing points of various FDM products
[37, Environment Agency of England and Wales, 2000]

A whole range of methods and equipment for freezing foods is available. The most common freezers used are blast, belt, fluidised bed, cooled surface, immersion and cryogenic freezers. Cryo-extraction and concentration by cold are also used.

In blast freezers, cold air at -30 to -40 °C is circulated over the food at a velocity of 1.5 to 6 m/s. In batch blast freezers, the food is stacked on trays in rooms or cabinets. In continuous equipment, trays covered with food are stacked on trolleys or the food is moved through a freezing tunnel by conveyor belts. Sometimes multiphase tunnels are applied with a number of belts. The product falls from one belt onto another, this also breaks up clumps of frozen food. The thickness of the food layer on the belts can vary from 25 to 125 mm. In blast freezers, large volumes of air are recycled, however, this can cause freezer burn and oxidative changes to unpackaged food. Moisture from the food is transferred, via the air, to the refrigeration coils, which makes frequent defrosting necessary. Impingement freezing and cooling with air velocities of up to 45 m/s and down to -50 °C is also applied.

The operating principle of a countercurrent freezer, e.g. a belt freezer or a spiral freezer, is the same as that of a blast freezer, except the food being frozen is transported through a countercurrent of cold air or liquid nitrogen. This reduces the evaporation of water from the food.

In fluidised bed freezers, the food is fluidised with air of -25 to -40 °C by passing the air vertically upwards through a perforated tray or conveyor belt and through a bed of food 2 to 20 cm thick. The shape and size of the food pieces determine the thickness of the fluidised bed and the air velocity for fluidising. In this system, food comes into more extensive contact with the air than in blast freezers, so that all surfaces are frozen simultaneously and uniformly. This results in faster freezing and less dehydration, which also results in less frequent defrosting. Fluidised bed freezing is restricted to small particulate foods, e.g. peas, sweet maize kernels, shrimps, and strawberries.

In cooled surface freezers, vertical or horizontal hollow plates are cooled with a refrigerant of about -40 °C. The food is put on the surface in thin layers. Sometimes the plates are pressed slightly together. This improves the contact between the food and the freezing plates. One advantage of such freezers is that little dehydration of the food takes place, which reduces the frequency of defrosting. A special form is the scraped surface freezer. This consists of a freezing cylinder containing rotating knives which remove the frozen material from the freezing surface. This type of equipment is used, e.g. in ice-cream production.

In immersion freezers, packaged food is passed through a bath of refrigerated glycol, brine, glycerol or calcium chloride solution on a submerged mesh conveyor. High freezing rates are obtained with this method. It is used, e.g. for freezing concentrated orange juice in cans and for pre-freezing film wrapped poultry prior to blast freezing.

In cryogenic freezing, the food is in direct contact with the refrigerant, which can be solid or liquid carbon dioxide or liquid nitrogen. The refrigerant evaporates or sublimates away removing the heat from the food and causing rapid freezing. Liquid nitrogen and carbon dioxide refrigerants are colourless, odourless and inert.

Cryo-extraction is a method of subtractive enrichment which consists of removing water from bunches of grapes to increase the sugar content of the must. The objective of cryo-extraction is to eliminate some water present in the raw material by selective freezing. The grapes are placed in a coldroom at a temperature midway between the freezing temperature of the richest grapes and that of the least rich grapes. The duration of the treatment of the grape crop is from 12 to 20 hours at temperatures of between -3 and -6 °C. The technique is performed only on grapes harvested manually and carried out in low, perforated crates, to achieve a slow and homogeneous lowering of the temperature over all the grapes. The pressing makes it possible to select the ripest juices, i.e. those which flow out first. The maximum pressure used for pressing is 4 bar.

Finally, concentration by cold is a technique applied only for wines. It consists of eliminating a part of the water from a wine to increase its alcohol strength. This technique is regulated. The wine is cooled below the temperature where ice crystal forms, but the alcohol does not freeze. The crystals are prevented from congealing together by constant mixing. When a sufficient quantity of water has thus solidified, the liquid is separated from the crystals by centrifuges or pressure operated extractors.

2.1.7.3 Freeze-drying/lyophilisation (G.3)

2.1.7.3.1 Objective

Freeze-drying or lyophilisation, is the process of removing water from a product by sublimation and desorption. The aim of the process is to preserve sensitive material that cannot be dried by evaporation. Beware of the risk of degradation of specific components at high temperatures, which would result in a loss of taste or other quality aspects.

2.1.7.3.2 Field of application

The technique is used, e.g. for drying coffee extracts, spices, soup vegetables, instant meals, fish and meat.

2.1.7.3.3 Description of techniques, methods and equipment

The freeze-drying equipment consists of a drying chamber with temperature controlled shelves. This can be a batch chamber, where the trays remain fixed on the heating plates through the drying operation, or a semi-continuous type, in which the trays move through a vacuum lock into a drying tunnel. The equipment also includes a condenser, to trap water removed from the product in the drying chamber and to facilitate the drying process; a cooling system, to supply refrigerant to the shelves and the condenser, and a vacuum system, to reduce the pressure in the chamber.

If the incoming product is a liquid, e.g. coffee extract, it is frozen in two steps, at two freezing temperatures and times, and then it is ground. The solid material is then fed manually or mechanically onto the trays in a drying chamber. The temperature of the drying chamber is well below 0 °C. The exact temperature depends on the product being dried. A vacuum is applied in the chamber. The ice evaporates under these conditions. This evaporation causes a further decrease in the temperature of the product, which is compensated for by adding heat by means of heating plates to the product through the temperature controlled trays. The evaporated water is refrozen on the surface of a condenser, which has a temperature well below the sublimation temperature under the existing conditions in the chamber. From time to time the condenser is de-iced by heating the condenser surface. The water is liquified and drained. The vacuum is maintained by a vacuum pump. The outlet of the vacuum pump is emitted into the air. To prevent solids entering and damaging the vacuum pump, a filter is usually applied in front of the pump.

2.1.8 Post processing operations (H)

2.1.8.1 Packing and filling (H.1)

2.1.8.1.1 Objective

The objective of packing is to use any products made of any materials of any nature for the containment, protection, handling, delivery and presentation of goods. Packing may be applied to raw materials and to processed goods. Filling is the process of putting the product in the package in a proper way.

2.1.8.1.2 Field of application

The majority of food products are packaged before they enter the distribution chain. In some cases packing is an integral part of the production process, which means that the packaged product is further processed. An example of this is the canning and bottling of foods and subsequent heat conservation.

2.1.8.1.3 Description of techniques, methods and equipment

The European Parliament and Council Directive 94/62/EC [213, EC, 1994], states the following:

Article 3

Definitions for the purposes of this Directive:

1. “packaging” shall mean all products made of any materials of any nature to be used for the containment, protection, handling, delivery and presentation of goods, from raw materials to processed goods, from the producer to the user or the consumer. “Non-returnable” items used for the same purposes shall also be considered to constitute packaging.

“Packaging” consists only of:

- (a) sales packaging or primary packaging, i. e. packaging conceived so as to constitute a sales unit to the final user or consumer at the point of purchase;
- (b) grouped packaging or secondary packaging, i. e. packaging conceived so as to constitute at the point of purchase a grouping of a certain number of sales units whether the latter is sold as such to the final user or consumer or whether it serves only as a means to replenish the shelves at the point of sale; it can be removed from the product without affecting its characteristics;
- (c) transport packaging or tertiary packaging, i. e. packaging conceived so as to facilitate handling and transport of a number of sales units or grouped packagings in order to prevent physical handling and transport damage. Transport packaging does not include road, rail, ship and air containers;

Most FDM products involve primary, secondary and tertiary packaging processes throughout the manufacture and distribution chain.

The packaging materials used in the FDM sector are textiles, wood, metal, glass, rigid and semi-rigid plastic, flexible plastic films, paper and board.

Textiles have poor barrier properties. Textile bags are still used to transport bulk products including grain, flour, sugar and salt. Wooden shipping containers have traditionally been used for a range of foods, such as fruits, vegetables, tea, wines, spirits and beer. Wooden containers were replaced a long time ago in some sectors, and are now increasingly being replaced everywhere by plastic drums and crates.

Hermetically sealed, metal cans have high barrier properties and can withstand high and low temperatures. The materials used for metal cans are steel (tinplate or tin-free), and aluminium, but they may also be coated with tin or lacquers to prevent interactions with the foods within the can. Metal cans are widely used for soft drinks and beer. They are also used for canning sterilised foods, e.g. fruit, vegetables, condensed milk and meat products. Metal cans are recyclable. Aluminium foil is also widely used to pack several types of food.

Glass has high barrier properties, is inert, and is suitable for heat and microwave processing. However, two disadvantages of glass are the weight and the risk of fracturing. Glass bottles and jars are widely used for milk, beer, wines and spirits, preserves, pastes and purées and also for some foods and instant drinks. Glass bottles and jars are re-usable and recyclable.

Rigid and semi-rigid plastic containers include bottles, jars, cups, trays and tubs made from single or co extruded polymers. They are low weight, tough and unbreakable, easy to seal, have reasonably high barrier properties and great chemical resistance. Several techniques are available for the production of these containers, such as thermoforming, blow moulding, injection blow moulding, extrusion blow moulding and stretch blow moulding. Typical materials used are PVC (polyvinylchloride), PS (polystyrene), PP (polypropylene), XPP (expanded polypropylene, for thermoforming), HDPE (high density polyethylene), PET (polyethylene terephthalate), and polycarbonate. The containers are often made on-site. Some of the containers are re-usable, e.g. polycarbonate bottles for milk. Rigid and semi-rigid plastic containers are typically used for milk, soft drinks, dairy products, margarine, dried foods and ice-cream.

Flexible films are formed from non-fibrous plastic polymers, which are normally less than 0.25 mm thick. Typical materials used for flexible films are PE (polyethylene), LDPE (low density polyethylene), PP, PET, HDPE, PS, and PVC. In general, flexible films are relatively cheap; they can be produced with a range of barrier properties; they are heat sealable; add little weight; can be laminated to paper, aluminium and other plastics; and are easy to handle. Flexible films are used for packaging a large range of both wet and dry food products.

Finally, paper and board can be produced in many grades and many different forms. It is recyclable and biodegradable and can easily be combined with other materials. Laminated cardboard packs are used on a large scale for milk and fruit juices. Paper and board are also extensively used for food packaging and often as secondary packaging.

An important step in the packing process is the sealing of the container or packs. The maintenance of the food quality depends largely on adequate sealing of the packs. Seals are usually the weakest part of the packs and also suffer most frequent faults during production, e.g. when food is trapped in a seal, incorrect sealing temperatures or incorrect can seamer settings. Cans are seamed and bottles and jar glass are sealed with metallic caps, plastic caps or cork. Form-fill-sealing is now a well established technique. In this process, the container is formed and partly sealed, filled and then finally closed by full sealing.

The requirements for filling are accuracy, to ensure that the required amount of product is packed and hygiene, to ensuring that the product is hygienically filled at the correct temperature to guarantee the highest possible quality and optimum shelf-life. The selection of an appropriate filling technique depends on the nature of the product and the production rate required. The filling can be by level, volume or weight.

Level filling is most frequently used in the drink industry, especially for beer. Volumetric filling is applied to liquids, pastes and powders. The most common is the piston filler. Finally, weight filling is applied to large particulate materials, e.g. confectionery. These are filled into containers using a photoelectric device, to count individual pieces. Also multi-head weighers are being developed which aim to weigh different products simultaneously, prior to filling into the same container.

Containers need to be filled accurately without spillage and without contamination of the seal. The filling of liquid foods like milk and fruit/vegetable juices can be categorised by the temperature of the food at the time of filling, e.g. hot, ambient or fresh cold filling, or as aseptic filling. The temperature ranges involved in the filling process are best illustrated by the hot filling and fresh cold filling processes. Hot filling is undertaken at temperatures of up 95 °C, to inactivate certain relevant micro-organisms, whilst many drink products are formulated with ingredients that do not need to be heat treated to be microbiologically safe and these are, therefore, fresh cold filled at between 0 and 5 °C. For aseptic packing, pre-sterilised, e.g. by hydrogen peroxide, containers are necessary, and the filling needs to take place in a sterile zone.

2.1.8.2 Gas flushing and storage under gas (H.2)

2.1.8.2.1 Objective

Gas flushing is a process in which products are stored in an artificially produced atmosphere, normally within a plastic container such as a hermetically sealed tray or pouch. The process is also referred to as modified atmosphere packing (MAP), and is used to enhance the colour-retention of, e.g. fresh meat or cured meats such as bacon and cooked ham, especially in sliced form. MAP is also applied to extend shelf-life. The impact of MAP depends on the combination of product, packaging materials and gas mix.

Storage under gas is applied to wines. Inert gas is applied to wines in tanks in place of sulphur dioxide (SO₂). This is carried out to preserve an adequate CO₂ content and the organoleptic qualities of the wine, to protect it from oxidation, and to the prevention of bacterial deviations. It also allows the prevention in the alteration of tanks which would be emptied, e.g. in the case of bulk sales to private individuals. Finally, it permits the conservation of sterile fruit juices.

2.1.8.2.2 Field of application

Gas flushing is mainly used for meat and meat products. It is also used for bakery products. Storage under gas is, above all, applied to white wines, rosés and red primeurs.

2.1.8.2.3 Description of techniques, methods and equipment

In gas flushing, the gas mixtures used will vary depending on whether the meat to be protected is fresh or cured. The desirable bright red colour of fresh meat can be prolonged by storage in an atmosphere with some oxygen, whereas the purple-red colour of uncooked cured meat and the pink colour of cooked cured meat is preserved better in an atmosphere completely free of oxygen. In all types of meat or meat products, gas mixtures are used which also contain carbon dioxide (CO₂). This inhibits bacterial growth on the meat and marginally extends the shelf-life. Normal air contains 78 % nitrogen, 21 % oxygen, and less than 1 % CO₂. In comparison, typical gas mixes for use with meats and meat products are shown in Table 2.5.

	Nitrogen	Oxygen	CO ₂
Fresh meat	20 %	60 %	20 %
Cured meats	80 %	0 %	20 %

Table 2.5: Typical gas mix composition for gas flushing
[1, CIAA, 2002]

Solid CO₂, usually in pellet form, can be added to meat during size reduction. This has the effect of rapidly reducing the temperature of the mixture and creating a blanket of inert gas over the surface of the meat, thereby enhancing the colour retention. A temporary increase in the CO₂ content of the air surrounding the equipment will occur, but this dissipates rapidly.

Solid or liquid nitrogen or CO₂ is sometimes used to partially freeze meats prior to slicing. This involves passing the pieces of meat to be sliced through a tunnel in which they are sprayed with the liquefied gas to reduce their temperature to about -8 °C. In such instances, extractor fans are located near the ends of the tunnel to expel the surplus gas to the air. No adverse effects have been reported.

Storage under gas consists of putting a gas, which can be either food quality nitrogen or a nitrogen/CO₂ mixture, in a tank under very slight overpressure of 0.1 to 0.2 bar. Nitrogen is used in a compressed state in steel containers. CO₂ is used in a liquefied form under pressure.

2.1.9 Utility processes (U)

2.1.9.1 Cleaning and disinfection (U.1)

2.1.9.1.1 Objective

Processing equipment and production installations are cleaned and disinfected periodically to comply with legal hygiene requirements. The frequency can vary considerably depending on the products and the processes. The aim of cleaning and disinfection is to remove product remnants, other contaminants and micro-organisms.

2.1.9.1.2 Field of application

The whole FDM sector.

2.1.9.1.3 Description of techniques, methods and equipment

Before starting the cleaning process, equipment is emptied as far as possible. Cleaning and disinfection can be carried out in various ways. Traditionally, it has been carried out manually. Cleaning in place (CIP), washing in place (WIP) and, cleaning out of place are all expressions used for different ways of cleaning. Cleaning agents are delivered in a variety of ways, e.g. in bags, e.g. powdered cleaning agents, drums or bulk tankers. Many cleaning agents are potentially hazardous to the health and safety of the operator and systems can be provided to minimise the risk during the storage, handling, use and disposal.

CIP is used especially for closed process equipment and tanks, whether stationary or small mobile, processing units. The cleaning solution is pumped through the equipment and distributed by sprayers in vessels, tanks and reactors. The cleaning programme is mostly run automatically, and applies the following steps; pre-rinse with water, circulation with a cleaning solution, intermediate rinse, disinfection, and final rinse with water. In automatic CIP systems, the final rinse-water is often re-used for pre-rinsing or may be recycled/re-used in the process. In CIP, high temperatures of up to 90 °C are used, together with strong cleaning agents. CIP systems used for open systems like freezers are almost entirely automatic, except for some dry clean-up and opening of hatches. Temperatures for medium pressure systems are normally below 50 °C and the pressure is 10 to 15 bar.

Cleaning out of place is used when several of the machine's components need to be dismantled, usually before the manual or automated cleaning of the machine is started. The dismantled components are cleaned separately outside the machine. Forming machines are one example of this. There are augers, pistons, valves, forming plates and seals which all have to be dismantled before cleaning the machine. High pressure jet cleaning, using gels and foams can be carried out manually or automatically. The appropriate cleaning method is an appropriate combination of cleaning factors such as water, temperature of the cleaning solution, cleaning agents, i.e. chemicals, and mechanical forces. Only mild conditions, with regard to temperature and cleaning agents, can be used for manual cleaning.

High pressure jet cleaning and foam cleaning are generally applied for open equipment, walls and floors. Water is sprayed at the surface to be cleaned usually at a pressure of about 40 to 65 bar. Cleaning agents are injected into the water, at moderate temperatures of up to 60 °C. An important part of the cleaning action takes place due to mechanical forces.

In foam cleaning, a foaming cleaning solution is sprayed onto the surface to be cleaned. The foam adheres to the surface. It stays on the surface for about 10 to 20 minutes and is then rinsed away with water. Foaming can be carried out both manually and automatically. Gel cleaning is similar to foam cleaning.

In some cases, cleaning is undertaken using hot water only, however, this depends on the nature of the product and the process, nevertheless, cleaning agents are normally used in the FDM sector. Cleaning agents are typically alkalis, i.e. sodium and potassium hydroxide, metasilicate and sodium carbonate; acids, i.e. nitric acid, phosphoric acid, citric acid and gluconic acid; composed cleaning agents containing chelating agents, i.e. EDTA, NTA, phosphates, polyphosphates; and phosphonates, surface active agents, and/or enzymes. Disinfectants, such as hypochlorites, iodophors, hydrogen peroxide, peracetic acid and quaternary ammonium compounds (QACs), can be used.

2.1.9.2 Energy generation and consumption (U.2)

2.1.9.2.1 Objective

FDM manufacturing requires electrical and thermal energy for virtually every step of the process. Electricity is needed for lighting, for process control of the installation, for heating, for refrigeration and as the driving power for machinery. It is usually generated and supplied by utility companies. When steam and electricity are generated on site, the efficiency factor can be considerably higher.

2.1.9.2.2 Field of application

Required by all processes.

2.1.9.2.3 Description of techniques, methods and equipment

Thermal energy is needed for heating processing lines and buildings. The heat generated by the combustion of fossil fuels is transferred to the consumers by means of heat transfer media, which, depending on the requirements, are steam, hot water, air or thermal oil.

The basic boiler/generator design generally consists of a combustion chamber, where fuel combustion takes place. The heat is initially transferred by radiation, followed by a tubular heat-exchanger for heat transfer by convection. The hot flue-gas and heat transfer media are separated from each other by a specially designed heat-exchange system. Thermal efficiencies of heat generators very much depend on the application and fuel type. Efficiencies, calculated on the basis of lowest calorific value, range from 75 to 90 %. Some products are heated up by means of direct radiation with open flames or convection with directly heated process air. In this particular case, natural gas or extra light fuel oil is burned.

In-house combined generation of heat and power (CHP) is a valuable alternative for FDM manufacturing processes for which heat and power loads are balanced. The following cogeneration concepts are used in the FDM sector; high pressure steam boilers/steam turbine, gas turbines or gas engines or diesel generators with waste heat recovery for steam or hot water generation. The overall fuel utilisation factor of CHP systems exceeds 70 % and is typically about 85 %. Energy efficiency can be up to 90 or 95 % when the exhaust gases from a waste heat recovery system, such as a steam boiler, are used for other drying purposes. The fuel conversion efficiency greatly exceeds that of any design of a commercial power station, even the latest generation of combined cycle gas turbines, which can achieve a conversion efficiency of 55 %. Sometimes surplus electricity can be sold to other users.

Natural gas and fuel oil are the most convenient fuels. However, a few installations still burn solid fuels such as coal or process wastes. The utilisation of process wastes can be a convenient and competitive source of energy, and additionally helps to reduce the cost of off-site waste disposal.

2.1.9.3 Water use (U.3)

2.1.9.3.1 Objective

A large part of the FDM sector cannot operate without a substantial amount of good quality water. Without sufficient good quality water it is impossible to produce high quality products. In the FDM sector, hygiene and food safety standards have to be maintained.

A systematic approach to controlling the use of water and reducing water consumption and its contamination is generally effective.

Each application of water requires its own specific quality. In the FDM sector, the quality requirements depend on whether or not contact between water and the food product is possible. Water that comes into contact with the product must, with a few exceptions, at least be of drinking water standard. Both chemical and microbiological quality aspects are important. It is advisable to conduct a regular check of the microbiological parameters of the water at the most critical places, i.e. at the point of use. This is normally incorporated in the hazard analysis critical control point system (HACCP). The quality standards for drinking water are laid down in the Council Directive 98/83/EC [66, EC, 1998].

The treatment required to produce safe water quality depends very much on the water source and its analysis. There is no general rule. A minimum treatment concept involves water filtering, disinfecting and storage, but depending on the water requirements, may also include de-ironing, desilication, or active carbon filtering. Treated drinking water is pumped from the storage tank and distributed through the installation pipework network to the users.

Additional treatment, such as softening, dealkalising, demineralising or chlorinating the water, is needed for usage in specific food processes or utilities. Ion exchangers or membrane filtration processes are the most common techniques used for this purpose.

Water pollution control can be carried out by reducing the volume and strength of waste water generated, by in-process techniques such as eliminating or decreasing the concentration of certain pollutants, e.g. dangerous and priority hazardous substances; recycling or re-using water or end-of-pipe techniques, i.e. waste water treatment, or a combination of these.

The following sources of water are used in the FDM sector: tap water, groundwater, surface water, rainwater, water originating from the raw material and process water.

Tap water is distributed by a water main. The supplier is usually responsible for the quality of the water delivered and for checking the quality of the water regularly.

The composition of groundwater is generally reasonably constant and microbiological counts are mostly low, especially in deep bore holes. In most cases, little treatment is necessary before groundwater can be used as process water or cooling water. In most countries, a licence is needed for the extraction of groundwater. The quality of the groundwater is monitored by the user. Sometimes the authorities require notification of the results of regular water quality analyses.

Surface water cannot be used for process water unless it is treated first. When available, it is often used for cooling water. A licence may be required for such use.

Depending on the region, rainwater may be a source of water. This requires a storage basin. After appropriate treatment and control, rainwater may be used for process water, in open cooling systems.

Some raw materials that are processed in the FDM sector contain a considerable percentage of water as a liquid water phase, which can be separated from the solid constituents for separate utilisation. This separation can be carried out, e.g. by pressing, centrifuging, evaporation or by using membrane techniques. Some examples are fruit juice, potato juice, sugar beet juice and milk. Such liquids can mostly be utilised if they are not used as a primary product. Sometimes they can be used without further treatment, e.g. condensate of the first stages of evaporators for boiler feed-water, but otherwise appropriate treatment is necessary.

Process waters may be used from, e.g. chiller water, pump seal water, recovered condensate, final cleaning rinses.

2.1.9.3.2 Field of application

Water is used in the FDM sector for:

- food processing, where the water either comes into contact with, or is added to, the product
- equipment cleaning
- installation cleaning
- washing of raw materials
- water which does not come into contact with the product, e.g. boilers, cooling circuits, refrigeration, chillers, air conditioning and heating
- fire fighting.

In principle, the water used in the FDM sector may be used as process water, cooling water or boiler feed-water. These are described in Sections 2.1.9.3.3, 2.1.9.3.4 and 2.1.9.3.5.

2.1.9.3.3 Process water

In the FDM sector, process water is used for direct preparation of products or other items which come into direct contact with the products, cleaning and disinfection, regeneration of water treatment equipment and for various technical purposes. Water that comes into contact with the product must, with a few exceptions, at least be of drinking water standard. For the production of soft drinks and beer, often special quality characteristics are required that sometimes exceed those of drinking water quality. In fruit and vegetable processing, re-use of water is common practice, sometimes with some treatment, such as filtration, during the unit operations prior to blanching.

Examples of process water that is used for direct preparation of products or other items which come into direct contact with the products include:

- starting up of continuous process lines such as in pasteurisers and evaporators
- flushing-out the product from the process equipment at the end of a production run
- washing raw materials and products
- wet transport, e.g. in a flume
- dissolving ingredients and
- in the production of drinks.

Water of varying quality can be used for cleaning and disinfection purposes. The main steps involved in these processes are pre-rinsing with water, cleaning with cleaning agents, post-rinsing with water, and disinfection. Water is also needed for cleaning the outside of equipment, walls and floors. In this case, contact with the food product is rather unlikely, so drinking water quality is not required. However, often drinking water quality is used, to avoid any hazard.

Large quantities of process water for the regeneration of water treatment equipment are required for the removal of iron and/or manganese and for product softening and demineralisation. This water needs to be of good quality, to prevent bacteriological contamination of the filter material and the need for the water to be treated afterwards. Furthermore, it is preferable if water has a low iron content and low hardness, to prevent rapid fouling and scaling of equipment.

Finally, process water is also used for other technical purposes, e.g. cooling water is used for pump seals, seal water for vacuum pumps and water in closed circuits for hot water systems and heat-exchange systems. Water is also used for air conditioning humidity control in storage areas and for processing raw materials. If there is a risk that in the event of equipment failure, contact with the food product is possible, the water needs to be of drinking water quality.

2.1.9.3.4 Cooling water

Cooling water is the water used for the removal of heat from process streams and products. In the FDM sector, the cooling systems commonly applied are once-through cooling systems with no recirculation of cooling water, closed circulation cooling systems, open circulation cooling systems or cooling towers and cooling by direct contact with cooling water.

Cooling water is used in direct contact with food, e.g. after blanching of fruit and vegetables and to cool, e.g. cans and glass bottles after sterilisation.

In open cooling systems, i.e. cooling towers, not only does evaporation of the water occur but also a small part of the water is sprayed. Furthermore, in a cooling tower the conditions for growth of *Legionella* bacteria are favourable. This means that the spray of cooling towers, if contaminated, may be a possible source of legionnaires' disease. To prevent the occurrence of legionnaires' disease, companies which operate these systems must comply with regulations requiring them to manage, maintain and treat them properly [190, Health and Safety Executive, 2004]. Amongst other things, this means that the water must be treated and the system cleaned regularly. Air quality from cooling systems comes within the scope of the "Cooling BREF" [67, EC, 2001].

2.1.9.3.5 Boiler feed-water

In the FDM sector, steam is generated using boilers with working pressures of up to about 30 bar. For power generation with steam turbines, higher steam pressures are needed. Steam is used for the sterilisation of tanks and pipelines. Another application is UHT treatment with direct steam injection. Sometimes steam injection is used for heating the product or for adjusting the water content of the raw material. In all these cases, more or less direct contact between steam and the food product is possible so drinking water quality is required.

Requirements generally depend on the working pressure and temperature of the boiler and the conductivity [68, European confederation of organisations for testing, 1984]. The higher the pressure and temperature, the higher the quality requirements are. This makes extensive water treatment necessary, e.g. removal of iron, softening and chemical conditioning. The quality of the boiler water is controlled by the quality of the boiler feed-water. The frequency of boiler water blowdown also controls the quality.

It is important that boiler feed-water does not cause scaling in the boiler or corrosion of the steam system. This means that boiler feed-water has to have a very low hardness and be de-aerated. Returned condensate can also be used as boiler feed-water supplemented by suitably treated make-up water.

2.1.9.4 Vacuum generation (U.4)

2.1.9.4.1 Objective

Vacuums are used primarily to reduce the temperature at which operations take place, thereby reducing potential deterioration in the quality of the material being processed or, in the case of edible oil processing, to avoid unwanted oxidation of the product during processing at higher temperatures.

2.1.9.4.2 Field of application

A vacuum is applied to many unit operations in the FDM sector, e.g. drying, evaporation, neutralisation and filtration.

2.1.9.4.3 Description of techniques, methods and equipment

There are three basic systems for producing a vacuum, i.e. steam jet ejectors, reciprocating pumps, and rotary vacuum pumps.

A steam jet ejector, which can produce absolute pressures down to 1 or 2 mm Hg (133 or 267 Pa), consists of a steam nozzle that discharges a high velocity jet across a suction chamber connected to the equipment. The gas is entrained in the steam and carried into a venturi-shaped diffuser that converts the velocity energy of the steam into pressure energy. The steam and vaporised material from the ejector are condensed either directly in a spray of water, e.g. barometric condensers, or indirectly with surface type condensers or especially condensed under low temperature conditions, e.g. ice condensation below -20 °C.

With barometric condensers, the cooling water can be used on a once-through basis or recirculated, e.g. in a closed-circuit. In edible oil processing, for saponification of ffa, this is done over cooling towers, e.g. under high pH conditions. With indirect condensers, the condensate can be recovered. The size of the condenser depends on the cooling temperature used, and this also controls the amount of steam required. Chilling (see Section 2.1.7.1) or freezing (see Section 2.1.7.2) systems can be used to enable operation at low temperature, thereby reducing steam usage.

The reciprocating pump, which can produce absolute pressures down to 10 mm Hg (1333 Pa), is of the positive displacement type. Air is drawn into the pump chamber and then compressed by means of a piston before being discharged. Reciprocating vacuum pumps can be either single or multistage devices. The number of stages is determined by the compression ratio. The compression ratio per stage is generally limited to four.

Rotary vacuum pumps, which can produce absolute pressures as low as 0.01 mm Hg (1.33 Pa), are again of the positive displacement type, i.e. essentially constant volume with variable discharge pressure. The discharge pressure will vary with the resistance on the discharge side of the system. The widely used water-ring vacuum pump has the inlet and outlet ports located on the impeller hub. As the vaned impeller rotates, centrifugal forces drive the sealing liquid against the walls of the elliptical housing, causing the air to be successively drawn into the vane cavities and expelled with the discharge pressure.

2.1.9.5 Refrigeration (U.5)

2.1.9.5.1 Objective

The objective of refrigeration is to preserve products. Refrigeration equipment is needed for cooling, chilling and freezing (see Sections 2.1.7.1 and 2.1.7.2).

2.1.9.5.2 Field of application

In many FDM manufacturing processes, cooling is an important process step. Often mechanical cooling using refrigeration equipment is applied. Furthermore, many products are stored and distributed either chilled or frozen.

2.1.9.5.3 Description of techniques, methods and equipment

The main components of a mechanical refrigeration plant are the evaporator, the compressor, the condenser and the expansion chamber. The refrigerant circulates through these four components, changing in state from liquid to gas, and back to liquid again. In the evaporator, heat is absorbed from the surroundings. This causes part of the refrigerant to vaporise. Where ammonia is used as the refrigerant, the common temperatures of evaporation are -20 to -25 °C, which correspond to a pressure of 100 to 200 kPa.

Refrigerant vapour goes from the evaporator to the compressor where the pressure is raised to about 1000 kPa, which corresponds to a temperature of about 25 °C. The pressurised vapour then goes into the condenser, where the vapour is condensed. The heat absorbed by the refrigerant in the evaporator is released in the condenser. The condenser is cooled by water or air. The resultant liquid refrigerant then goes to the expansion chamber, where the pressure and temperature are reduced to restart the refrigeration cycle.

The common refrigerants used are ammonia (NH₃), halogen refrigerants, i.e. chlorofluorocarbons (CFCs) and partially halogenated CFCs (HCFCs). Ammonia has excellent heat transfer properties and is not miscible with oil, but it is toxic and flammable. Halogen refrigerants are non-toxic, non-flammable and have good heat transfer properties. The interaction of halogen refrigerants with ozone in the air has resulted in the progressive prohibition of the placing on the market and use of ozone depleting substances and of products and equipment containing those substances [202, EC, 2000]. There is currently a proposal for a Regulation of the European Parliament and of the Council on certain fluorinated greenhouse gases [246, EC, 2003].

Condensers of refrigeration equipment can be divided into three types. In air-cooled condensers, the refrigerant goes through fin elements, around which the cooling air circulates. Water-cooled condensers operate by circulating cooling water inside the tubes. This condenses the refrigerant on the external tube surface. The water-cooled condenser is cooled according to the water once-through system or with water which circulates over a cooling tower. The most common type of water-cooled condenser is the tube condenser. Finally, the evaporation condenser is a combination of an air-cooled condenser and a cooling tower. Water evaporates at the surface of the condenser.

2.1.9.6 Compressed air generation (U.6)

2.1.9.6.1 Objective

Compressed air is generated to run simple air tools, e.g. for pneumatic transfer, or for more complicated tasks such as the operation of pneumatic controls.

2.1.9.6.2 Field of application

Widely used in the FDM sector, e.g. on manufacturing and packaging lines.

2.1.9.6.3 Description of techniques

Oil-free compressed air is required in the FDM sector. The air used has to be of food quality. This is achieved by passing it through several filters at the outlet of the compressor.

2.2 The application of unit operations in the FDM sector

Providing a detailed description of every process applied in the FDM sector is beyond the scope of this document, which is why only the most common processing techniques applied were described in the previous section. The use of these unit operations in some of the sectors is summarised in Table 2.6.

The major processes in some FDM sectors are described in the following sections. The intention is to provide a degree of information rather than to give every detail about the processes.

	Meat	Fish	Meat	Potato	Fruit and veg.	Oil	Milk	Starch	Confectionery	Sugar	Beer	Malt	Non-alcohol drink	Spirit	Wine	Pet food	Coffee	Grain	Cereals	Dry pasta
A.1	Materials handling and storage	yes	yes	yes	yes	yes	yes	yes	yes	yes	yes	yes	yes	yes	yes	yes	yes	yes	yes	yes
A.2	Sorting/screening, grading, dehulling, destemming/destalking and trimming	yes	yes	yes	yes	yes		yes	yes		yes	yes		yes	yes	yes	yes	yes	yes	
A.3	Peeling			yes	yes															
A.4	Washing	yes	yes	yes	yes			yes		yes			yes		yes					
A.5	Thawing	yes	yes																	
B.1	Cutting, slicing, chopping, mincing, pulping and pressing	yes	yes	yes	yes		yes	yes	yes	yes					yes	yes				
B.2	Mixing/blending, homogenisation and conching	yes	yes		yes	yes	yes	yes	yes				yes	yes	yes	yes	yes	yes	yes	yes
B.3	Grinding/milling and crushing	yes	yes		yes	yes		yes	yes		yes			yes	yes	yes	yes	yes	yes	yes
B.4	Forming/moulding and extruding	yes	yes		yes	yes	yes	yes	yes				yes			yes			yes	yes
C.1	Extraction					yes			yes	yes					yes		yes			
C.2	Deionisation					yes	yes	yes												
C.3	Fining										yes				yes					
C.4	Centrifugation and sedimentation					yes	yes	yes	yes	yes	yes				yes		yes			
C.5	Filtration					yes	yes	yes	yes	yes	yes		yes	yes	yes		yes			
C.6	Membrane separation						yes	yes	yes				yes		yes		yes			
C.7	Crystallisation					yes	yes	yes		yes										
C.8	Removal of free fatty acids by neutralisation					yes			yes											
C.9	Bleaching					yes														
C.10	Deodorisation by steam stripping					yes			yes								yes			
C.11	Decolourisation							yes							yes					
C.12	Distillation					yes		yes						yes						
D.1	Soaking				yes							yes		yes						
D.2	Dissolving						yes	yes	yes		yes		yes							
D.3	Solubilisation/alkalising								yes											
D.4	Fermentation				yes		yes	yes			yes			yes	yes					
D.5	Coagulation						yes	yes	yes				yes							
D.6	Germination											yes								
D.7	Brining/curing and pickling	yes	yes		yes		yes													
D.8	Smoking	yes	yes				yes													
D.9	Hardening					yes			yes											
D.10	Sulphitation							yes		yes					yes					

D.11	Carbonatation									yes	yes		yes		yes					
D.12	Carbonation												yes		yes					
D.13	Coating/spraying/enrobing/ agglomeration/encapsulation	yes	yes		yes		yes	yes	yes							yes	yes		yes	
D.14	Ageing													yes	yes					
E.1	Melting					yes	yes		yes					yes						
E.2	Blanching			yes	yes															
E.3	Cooking and boiling	yes	yes	yes	yes				yes		yes			yes		yes				
E.4	Baking				yes				yes							yes			yes	
E.5	Roasting								yes							yes	yes		yes	
E.6	Frying	yes	yes	yes	yes				yes							yes				
E.7	Tempering								yes							yes				
E.8	Pasteurisation, sterilisation and UHT	yes	yes		yes		yes	yes	yes		yes		yes		yes	yes				
F.1	Evaporation (liquid to liquid)	yes	yes		yes	yes	yes	yes	yes	yes					yes		yes			
F.2	Drying (liquid to solid)			yes	yes	yes	yes	yes	yes							yes	yes			
F.3	Dehydration (solid to solid)		yes	yes	yes			yes	yes	yes		yes				yes	yes		yes	yes
G.1	Cooling, chilling and cold stabilisation	yes	yes	yes	yes	yes	yes	yes	yes	yes	yes	yes	yes	yes	yes	yes	yes		yes	
G.2	Freezing	yes	yes	yes	yes				yes						yes	yes	yes			
G.3	Freeze-drying/lyophilisation														yes		yes			
H.1	Packing and filling	yes	yes	yes	yes	yes	yes	yes	yes	yes	yes		yes	yes	yes	yes	yes	yes	yes	yes
H.2	Gas flushing and storage under gas	yes	yes				yes				yes	yes			yes		yes			
U.1	Cleaning and disinfection	yes	yes	yes	yes	yes	yes	yes	yes	yes	yes	yes	yes	yes	yes	yes	yes	yes	yes	yes
U.2	Energy generation and consumption	yes	yes	yes	yes	yes	yes	yes	yes	yes	yes	yes	yes	yes	yes	yes	yes	yes	yes	yes
U.3	Water use	yes	yes	yes	yes	yes	yes	yes	yes		yes	yes	yes		yes	yes	yes			yes
U.4	Vacuum generation	yes	yes	yes	yes	yes	yes	yes	yes	yes			yes			yes	yes			yes
U.5	Refrigeration	yes	yes	yes	yes	yes	yes		yes			yes	yes		yes	yes	yes			
U.6	Compressed air generation	yes	yes	yes	yes	yes	yes	yes	yes	yes	yes	yes	yes	yes	yes	yes	yes			

Table 2.6: Unit operations applied in different sectors
[1, CIAA, 2002, 87, Ullmann, 2001, 91, Italian contribution, 2001]

2.2.1 Meat and poultry

Beef, pork and poultry are the main types of meat processed in Europe. The activities of the meat sector can be divided into three areas, slaughtering (covered by the “Slaughterhouses and animal by-products BREF” [181, EC, 2003]), meat cutting and further processing.

Cutting is a size reduction of large to medium sized parts of food material. For cutting, knives, blades, cleavers and circular or straight saws are used. These are all electrically operated. Carcasses are cut into retail cuts of joints by the removal of bone, skin and fat. After cutting the meat, the fresh meat may be stored and dispensed under refrigeration. It can be sold in portions, or it may be combined with other products. Special derinding machines are used for separating rind and fat from pork carcasses.

The further processing of meat into, e.g. ham, bacon and sausage, is primarily carried out for preservation purposes but it is also important for taste. In the meat sector, raw meats, either whole muscles or altered meat particles, are restructured to the predetermined product characteristics.

For coarse-ground products, the meat particles are substantially reduced and then restructured back into a different physical form. The goal of muscle product processing is to keep an original intact tissue appearance in the finished product. Products, such as ham, roast beef, and turkey breast, are produced from whole muscles or sectioned muscles. An emulsifying process forms a matrix in which the fat particle is encapsulated with the protein membrane.

Grinding reduces particle size, and mixing assures uniformity of chemical composition as well as protein extraction. Chopping also reduces particle size and produces salt-soluble protein. Major processing equipment includes injectors and massagers for muscle products, grinders and mixers for coarse-ground products, and choppers and emulsifiers for emulsified products. Injecting and massaging processes facilitate brine distribution and protein extraction.

Preservation involving heat, e.g. cooking or frying, and dehydration produces foods that can be packaged and kept for an extended time at appropriate storage conditions. Preservation techniques such as fermentation, smoking, and brining/curing/pickling are used to diversify the market selection. All these processes offer a limited extension of the shelf-life by altering the environmental conditions which supports microbial growth.

The injection under pressure of a solution containing brining/curing/pickling ingredients is a widely used technique for extending the life of meat. The ingredients used are common salt, i.e. NaCl, often with sodium or potassium nitrite and other materials to impart special characteristics. This process is required for whole products such as ham, shoulder, bresaola and turkey. Traditional injection in-vein has ceased and today the technique uses multi-needle injectors, which allow a higher productivity and a major spread of pickle. The injector injects a predetermined dose of pickle containing different additives and ingredients, such as salts, polyphosphates, ascorbate, caseinate, nitrate, nitrite, glutamate and spices inside the ham or shoulder mass.

After the injections, a process which allows complete homogenisation of the ingredients and of the additives into the product takes place. This process also allows the extraction of a proteinous/saline fluid from the meat with binding effect. It involves massaging the meat inside a container turning around a vertical or inclined axis in a continuous or intermittent way, under vacuum and/or at a refrigerated temperature. Brining/curing by dry salt is required for the production of cured uncooked ham, bacon, and coppa. The latter two products can be also made in the massaging machine.

Raw meats, after these preparation processes, are stuffed into casings to form a defined geometric shape and size. During these processes, rheological properties are critical to the equipment performance and final product quality.

To recover fat from meat residues, wet melting or dry melting is used. In the wet melting process, the raw material is heated in a process kettle by direct steam injection to a temperature of about 90 °C. This results in a watery phase and a fat containing phase. The phases are separated by decantation and centrifugation. In the dry melting process, the raw material is indirectly heated in the processing kettle (a kettle with a steam jacket). All the water which evaporates is removed from the kettle under vacuum. The liquid phase or molten fat and the dry phase or fat-free meat residue are separated by decantation.

The meat sector is very diverse in terms of its products due to specific local tastes and traditions. However, three processes commonly used are canned meat, cooked ham, and cured ham production.

2.2.1.1 Canned meat (beef muscle in gelatine)

Different raw materials, such as cooked or uncooked, chilled or frozen meat may be used to produce canned meat. A general flow sheet is presented in Figure 2.3.

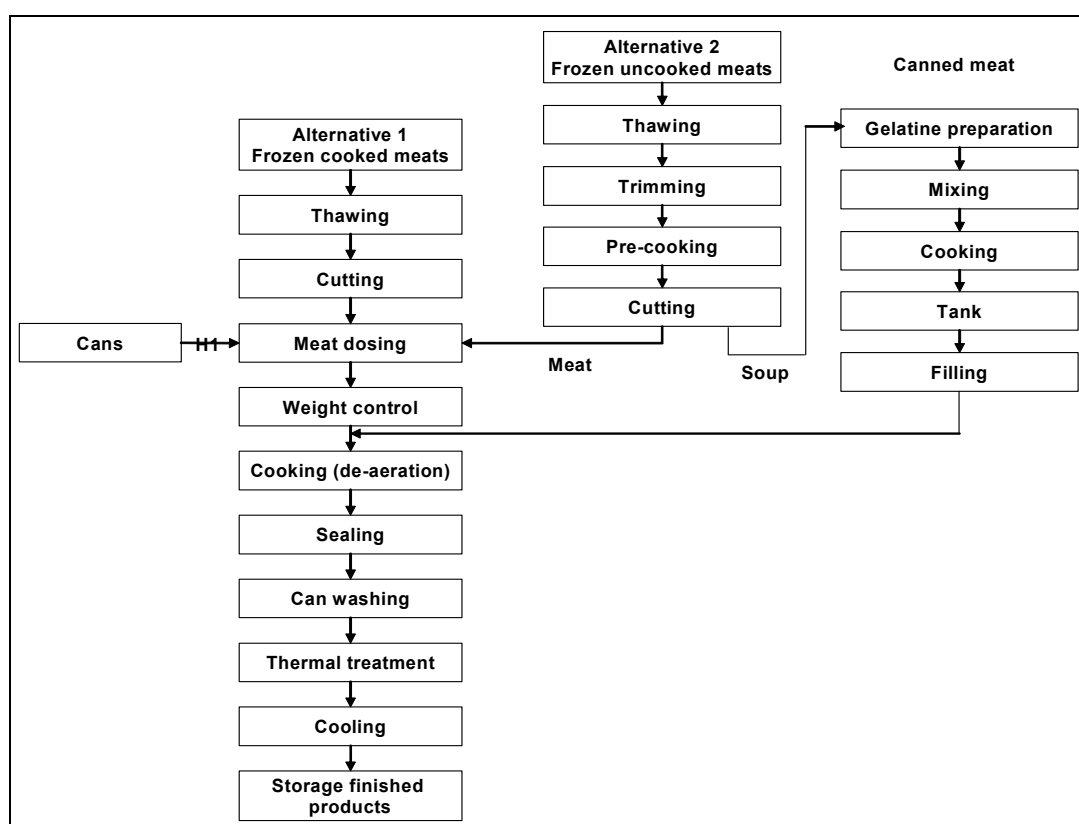

Figure 2.3: Canned meat production
[91, Italian contribution, 2001]

2.2.1.1.1 Thawing (A.5)

Frozen meat is generally transported in plastic bags inside a cardboard secondary packaging. Meat is stored at a temperature below -18 °C. Thawing can be achieved with air at a controlled temperature, or by an intermittent shower, or by immersion into running water. The two first methods allow a reduction in water consumption, but require longer times and larger surface areas. Moreover, the meat surface may be dried and its unsaturated fats, e.g. in pork, may be oxidised. When thawing in a water bath, the unpacked meat is put in iron crates and completely immersed in water at 15 to 18 °C. The water consumption is about 3 – 5 m³/t.

2.2.1.1.2 Cutting (B.1)

Fresh meat is trimmed to remove excess fat and may be deboned. About 12 % of by-products are produced in this step.

2.2.1.1.3 Mixing/blending (B.2)

Gelatine is prepared from industrial powder. It may come from the broth obtained during meat cooking if uncooked raw meat is used in the installation. Cooking one part of meat with one part of water gives 0.7 parts of cooked meat and 1.3 parts of broth. The broth is then filtered, boiled until the insoluble proteins precipitate, centrifuged, and filtered again. Finally, about one part of gelatine is produced. Ingredients, such as thickeners and flavours are added to the gelatine solution.

2.2.1.1.4 Packing and filling (H.1)

The gelatine is de-aerated and dosed in cans by a vacuum filler already containing the required part of meat. The cans are then sealed and washed with hot water to remove meat or gelatine residuals.

2.2.1.1.5 Sterilisation (E.8)

Cans are put in metal baskets and then sterilised in autoclaves, either in batch or continuous retorts, before being cooled.

2.2.1.1.6 Secondary packaging (H.1)

The cooled and dried cans are sent to be secondary packaged using cardboard boxes or bundles with a cardboard base and having a thermo-retractable wrap.

2.2.1.1.7 Refrigeration (U.5)

The product has a long shelf-life and does not need special care, apart from a good aeration to avoid condensation on the cans which may damage their external surfaces.

2.2.1.2 Cooked ham

The preservation of meat by cooking is used for several products, such as sausages, dressed pork and mortadella. The general process is shown in Figure 2.4.

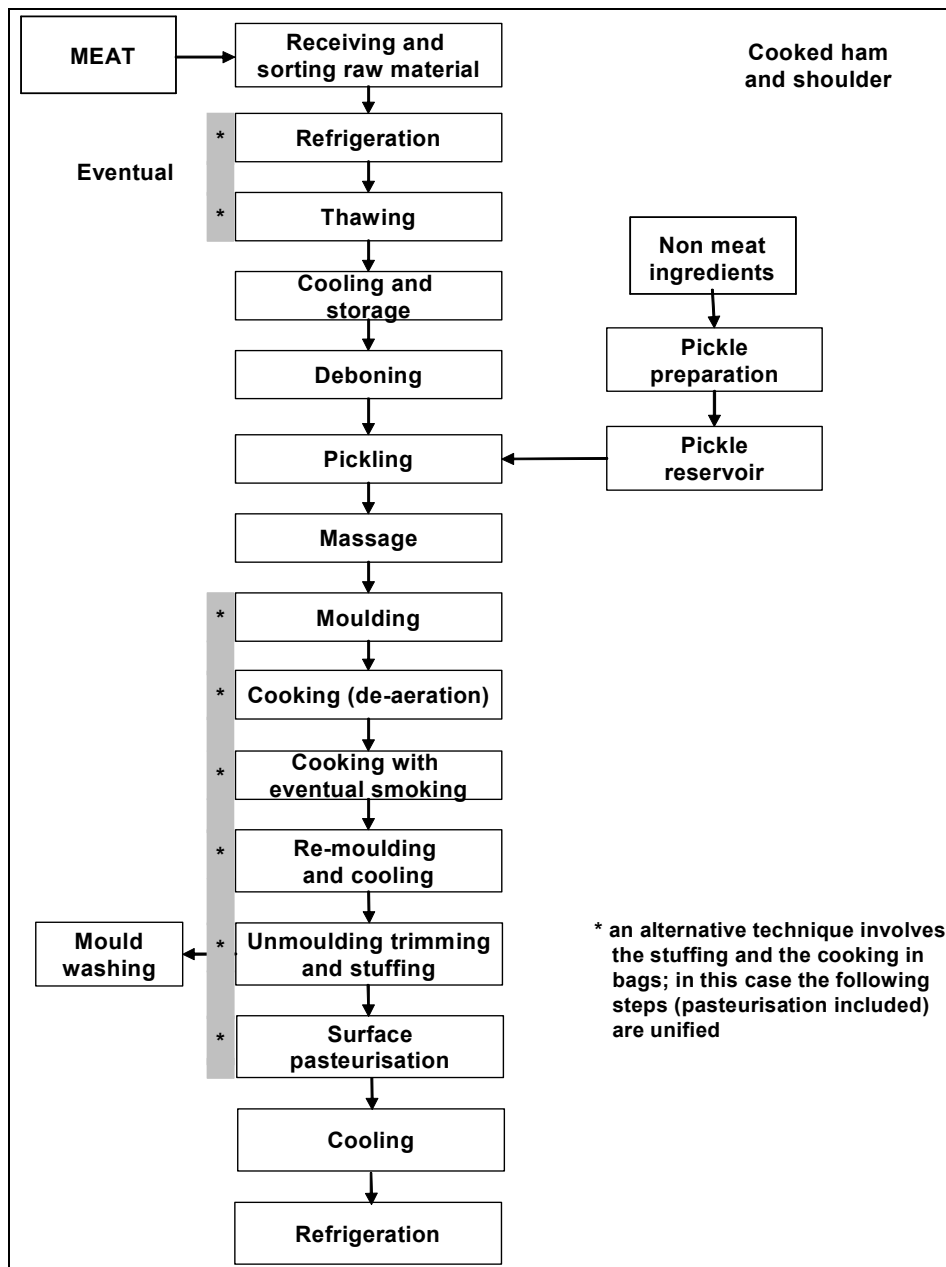

Figure 2.4: Cooked ham and shoulder production [91, Italian contribution, 2001]

First the material is received and then sorted.

2.2.1.2.1 Thawing (A.5)

This is similar to the canned meat process. In the production of whole hams or shoulders, the meat is held in a coldroom for 18 to 24 hours, to achieve a uniform temperature inside the meat. Losses can occur due to the dripping of meat juice.

2.2.1.2.2 Cutting (B1)

Ham and shoulders are manually (in an open or closed way) or mechanically (via a closed way) deboned, and degreased.

2.2.1.2.3 Pickling (D.7)

Pickle injection was traditionally made “in-vein”, however, nowadays it is achieved with multi-needle injectors leading to a higher productivity and a more uniformed distribution. The injector injects a predetermined dose of pickle containing different additives and ingredients, e.g. salts, polyphosphates, ascorbate, caseinate, nitrate, nitrite and glutamate, inside the ham or shoulder mass.

2.2.1.2.4 Homogenisation (B.2)

Massaging or churning allows the complete homogenisation of the ingredients and of the additives into the product, and it also allows the extraction of a proteinous/saline exudate with a binding effect. This process involves massaging the meat inside a container, which turns round a vertical or inclined axis in a continuous or intermittent way, under vacuum and/or low temperature.

2.2.1.2.5 Cooking (E.3)

After moulding, the product is de-aerated and cooked and/or smoked. The cooking can be carried out in a water bath, shower, steam or hot air ovens. Water bath ovens are used for whole meat products. However, a lot of water and energy is needed, major weight loss and water pollution occurs due to the leaching of meat, but the heat transfer is homogenous. Shower ovens provide good heating uniformity and use less water and energy. Steam ovens provide a moist humid heat, where food is cooked in a gentle environment to retain its flavour and moisture. Air ovens require humidity control.

Ham may also be re-moulded and then cooled. Moulds are removed and cleaned. Ham and shoulders are normally trimmed and may be sprinkled with flour to improve the look. Packing is normally carried out under vacuum.

2.2.1.3 Cured ham

Cured ham products, such as Parma from Italy, or Serrano from Spain have a good reputation because of their high quality. They are normally made of special and standard quality raw meat, e.g. typically Italian cured hams are made from 10 to 12 months old pig haunches of 150 to 180 kg weight. A similar process is used for other products, such as salami, dry sausages, and brawn. The general process is shown in Figure 2.5.

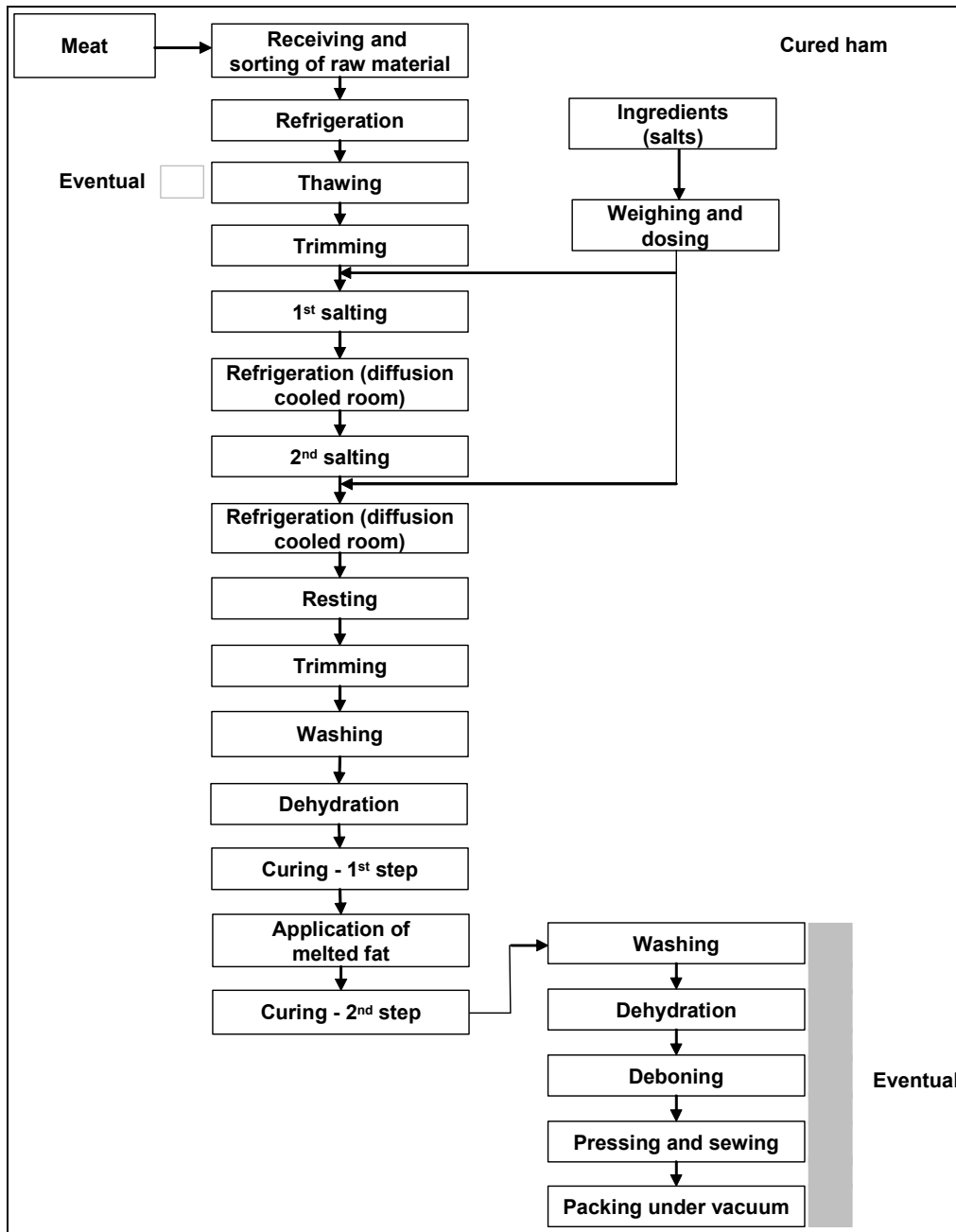

Figure 2.5: Cured ham production [91, Italian contribution, 2001]

Sorting, thawing, cutting and trimming, are all similar to the above described processes. Depending on the cuts, a partial peeling may be needed, e.g. for hams and bacon, as well as vein squeezing.

2.2.1.3.1 Brining/curing (D7)

Curing with dry salt is specific to the production of ham and bacon and can be carried out in the churn. The main component of the curing salt is normally NaCl. Its concentration in end-products has decreased from about 6 % to less than 2 %. Nitrites may be used as a preservative against *Clostridium botulinum* and other spoilage bacteria but they also impart palatability and appearance characteristics, namely a specific taste, texture, and pink colour. Only a small amount of residual nitrite, usually <10 ppm, remains in modern cured meats.

2.2.1.3.2 Ageing (D.14)

Ham spends long periods of time curing under strictly controlled conditions, e.g. temperature and air humidity. In the past, ageing could take one or more years, but today, with improved technology and modern processing installations along with old family secrets, a fully cured country ham can be produced within 6 to 12 months.

2.2.1.3.3 Washing (A.4)

Salt and meat residuals are removed by brushing and washing. This step produces a significant amount of waste containing fats, proteins and salt. Before washing, it is better to trim the area round the thighbone head and to cut the hip.

2.2.1.3.4 Coating (D.13)

Before drying, hams are checked and then coated and transported to the drying chambers. Coating comprises covering the muscular part of the pig legs with pork fat or a mixture of fat and salt, pepper and flour, which has been previously sterilised. The ham then remains in these large rooms for several months, up to one year. The humidity and temperature in the room are controlled.

2.2.1.3.5 Packing (H.1)

With some products, the bones are removed before packaging. Other usually more traditional products are sold with the whole pig leg.

2.2.1.3.6 Gas flushing (H.2)

As well as traditional methods, gas flushing is also often used for packing hams.

2.2.2 Fish and shellfish

This sector includes the process of white or pelagic fish; fatty fish; shellfish, i.e. crustaceans and molluscs, and fresh water fish. Fish processing is very widespread and varied. Many species of fish are mass processed, including cod, tuna, herring, mackerel, pollock, hake, haddock, salmon, anchovy and pilchards. Marine fish account for 90 % of the fish production in the world. The other 10 % includes fresh water fish and farmed fish. Approximately 75 % of the world's fish production is for human consumption, with the remaining 25 % used for producing fish-meal and fish-oil. Currently, about 30 % of all the fish produced for human consumption are marketed fresh.

Fish processing most commonly takes place at on-shore processing facilities. However, some processing such as the gutting, cleaning and sometimes head removal of fish can take place at sea, on board fishing vessels, e.g. when processing white fish that has a low oil content. These fish are then kept in ice or are frozen until they arrive at the installation, where they are thawed or re-iced and stored until the time of further processing. Fatty fish have oils distributed throughout the fillet and in the belly cavity. They have different oil contents depending on the species, but on average fatty fish fillets may have up to a 30 % oil content. Typically, they are not gutted on board, as this is carried out later in the processing installations.

The pretreatment of white fish involves the removal of any ice and a screening based on their size. Large fish may also be scaled depending on the process, although this is not carried out when skinning is performed.

Skinning and cutting involves removing the edible parts of the fish and cutting it into pieces of the appropriate size. Skinning can be done manually or automatically. With automatic operations, white fish are skinned by pulling the fillet over an automatic knife, whereas fatty fish are skinned by pulling the fillet over a freezing drum. Then, fish are transported, e.g. by fluming, to cutting tables from the holding vessels and then eviscerated, i.e. head, tails and inedible parts are removed. In small fish, such as sardines, only heads and tails are removed, and for medium sized and large fish the guts are removed as well. For white fish, this stage just involves the removal of the fillet flesh, whereas for oily fish the process involves gutting, de-heading and removal of fillets.

Fish and shellfish are processed and preserved by a large variety of methods and may be consumed in their primary form, raw or cooked. They may also be further processed to produce fish or shellfish-based foods, such as moulded products or prepared dishes. Some preservation methods involved in fish and shellfish processing include freezing, chilling, canning, curing, drying, smoking, fermenting and MAP.

2.2.2.1 Frozen processed fish/moulded fish products and fish fingers

During processing, frozen fish blocks, made from either layered fillets, jumbled or minced fish, are cut into the required dimensions. With moulded products, the fish off-cuts, seasoning and binding materials are fed into a moulding machine and formed into the required shape. The product then passes through a series of enrobing machines, which cover the fish with batter and/or breadcrumbs, with the type and number of enrobers being dependent upon the desired product. After enrobing, the product is fried in an edible oil. Temperatures vary but around 190 °C is typical. The fryers may be heated by thermal oil, gas or by electrical means. The fried product then travels into a freezing unit where it is subjected to a stream of cold air to reduce the product to a predetermined target temperature, -18 °C is typical.

2.2.2.2 Canned fish/shellfish products

Raw fish are washed, cut into fillets and then steamed in cooking/cooling tunnels. After head removal, white fish are filleted in machines with two sets of rotating knives that cut the fillets from the bone and cut off the collar bones. The knives are watered to cool them and to clean off fish meat and scale.

Next, the two fillets are conveyed skin-side down to the skinning phase. Fatty fish are orientated in a forward direction and held into position, using water jets, until aligned with a stop plate. They are de-headed and the tails and guts are taken out before entering the filleting machine. The two fillets then proceed to the skinning stage. Filleting and skinning may be carried out manually. Descaling is sometimes achieved using caustic baths. Fish off-cuts are normally transported to the waste collection area via chutes, water flumes or conveyor belts.

After steaming, the fish are filled into cans, which contain either brine, oil or sauce. The cans are sealed by passage through a can seamer. Precooking, skinning and cutting are carried out if medium size or large fish are processed. Small fish are put in cans whole and are cooked directly in the can.

After seaming, the cans pass into a retort for sterilisation. Here, the product is heated at a sufficient temperature to inactivate any food poisoning micro-organisms. The product is then cooled with chlorinated water. Shellfish are processed in a similar manner but are often transported under a rocking motion through a scalding system to open the shells and dislodge the flesh. Additional washing and trimming steps may also be incorporated to remove sand and mud.

The curing and smoking of fish and during processing of shellfish, may also be carried out.

2.2.2.3 Crustaceans

Once headed and washed, shrimps and prawns are preserved by icing or brine freezing before being transported to the processing installation. Chemicals, e.g. sodium bisulphite, are used to prevent black spots. After cooking, they are peeled and cooled with large amounts of water. Crabs are transported alive. Crab meat is picked, either manually or mechanically.

2.2.2.4 Molluscs

The types of molluscs processed and consumed in Europe mainly comprise cephalopods (cuttlefish, squid, octopus) and bivalves (oyster, mussel, clam and scallop). Processing includes freezing, canning and pickling. After cooking and shell removal, washing is often carried out by blowing air at the bottom of washing tank to agitate the meat, while the grit and shell particles settle down. Some molluscs, such as oysters or mussels are pickled with vinegar and spices. Here, the meat is dipped in 3 % salt brine, drained and covered for three days with a 3 % vinegar solution containing 3 % salt. They are then drained, packed and covered with spiced vinegar.

2.2.3 Fruit and vegetables

The characteristic features of fruit and vegetables are that they are soft edible plant products which, because of their relatively high moisture content, are perishable in their fresh state. A summary of the possible processing routes of some fruit and vegetables is shown in Table 2.7.

	Raw material	Processing	Preservation method
Garden vegetables	Peas, beans, spinach, potatoes, asparagus, maize and lentils	Put in packaging, in water	Thermal treatment
	Olives, cabbage, artichokes, mushrooms, onions, peppers, carrots and cucumbers	Put in oil, pickling/brining, sulphited	Natural or artificial thermal treatment
	Cabbage and cucumbers	Lactic acid fermentation	Microbial treatment
	Various garden vegetables	Juice	Thermal treatment
	Various garden vegetables	Dried	Drying
	Various garden vegetables	Freezing, deep-frozen and ready to use vegetables	Cooling
Tomato	Tomato	Paste	Dehydration and heat treatment
		Whole peeled	Thermal treatment
		Non-whole, peeled (diced or crushed)	Thermal treatment
		Juice, strained, passata	Thermal treatment
		Powder and flakes	Drying
Fruit	Berries, pears, apples, peaches, apricots, plums, pineapple, cherries and grapes	Put in water, in syrup	Thermal treatment, with optional synergetic action of sugar (reduction of a_w)
	Peaches, apricots, plums, cherries, berries and figs	Jam and jellies	Thermal treatment, with optional synergetic action of sugar (reduction of a_w)
	Citrus	Marmalade	Thermal treatment, with optional synergetic action of sugar (reduction of a_w)
	Pears, apples, peaches, apricots, plums, tropical fruits and undergrowth fruits	Juices and nectars	Thermal treatment
	Various fruits	Candies	Action of sugar (reduction of a_w)
	Various fruits	Concentrates	Thermal treatment (reduction of a_w)
	Various fruits	Put in alcohol	Reduction of a_w
	Various fruits	Dried fruits	Drying
Various fruits	Frozen and deep-frozen fruit	Freezing	

Table 2.7: Summary of the possible processing routes of some fruit and vegetables [91, Italian contribution, 2001]

2.2.3.1 Ready meals that predominantly contain fruit and vegetables

Some fruit and vegetables are preserved. For this purpose, depending on the type of fruit and vegetables, different processes are used, and a variety of products are made, e.g. ready meals. In most installations, a variety of fruit and vegetable types are processed simultaneously and consecutively into different products. The majority of installations process products in bulk and are subject to seasonal variations, in line with crop rotation. However, some have product lines are not affected by seasonal fluctuations. Further processing of frozen raw materials takes place throughout the year. Processing capacities are increasingly being expanded for such product processing.

2.2.3.2 Fruit juice

Fruit juices are produced throughout temperate and tropical areas of the world. Orange juice predominates in temperate climates and pineapple juice in tropical climates. The bulk of the world fruit juice production is from citrus fruits, mostly oranges, pomes; from apple and pear type fruits and from vine fruits. Some stone fruit juices are manufactured but in much smaller quantities.

In a typical citrus juice process, the fruit is sorted, graded and washed to remove extraneous matter such as sticks and leaves, adhering dirt and insects. The fruit is then passed through oil extraction equipment where it is subjected to hundreds of small cuts of the skin to rupture the oil sacs and release the citrus oil, which is removed by washing. Oil extraction may be carried out after juice extraction. The fruit juice is mechanically extracted and screened to remove excess pulp, pieces of skin and seeds. The screened juice is preserved by a number of methods such as canning, aseptic processing, chemical inhibition, freezing, and membrane separation. It may be concentrated before packaging to reduce transport costs. The juice may be clarified before or after preservation.

A typical pome juice process includes similar processes but without an oil extraction step. The fresh fruits are delivered to the processing installation and unloaded, washed, sorted and then crushed after eventual coring or pitting, e.g. for peaches and apricots. The white fruits are heated to avoid enzymatic browning. The crushed fruits are then strained and refined to extract the juice. For apple juice, the juice is sometimes clarified with an enzymatic treatment and filtration.

Orange, apple and tomato juices are often concentrated, normally by evaporation or in some cases by RO or cryoconcentration. The juice is obtained either from fresh fruits or from reconstituted concentrates from citrus, pineapple and other tropical fruits. It can be packed directly, as it is the case with juices, or mixed with sugar and water, as it is the case with nectars. The juices are then de-aerated and hot filled into bottles or cans.

Because of the low pH, filling with a HTST pasteurisation treatment is sufficient to stabilise the product when followed by bottle sterilisation in a steam tunnel. Aseptic packaging is carried out by pasteurising, cooling and filling, all in aseptic conditions. The filling is carried out in cardboard bricks or preformed bricks.

2.2.3.3 Heat treated fruit

In typical canned fruit processes, the fruit is ideally used as soon as possible after delivery, although it often has to be stored for a time under chilled conditions, e.g. apple. The fruit is first washed, then sorted and possibly trimmed, then graded or cored before peeling. A variety of methods are used for peeling, including abrasive, caustic, steam or mechanical peeling. Peeled fruit may be blanched or transferred to tanks containing materials such as brine or ascorbic acid solutions to prevent browning. If necessary, the fruit may be sliced. Products such as orange segments are subjected to acid and caustic soaks to remove stringy fibres before canning. The fruit is filled into containers, e.g. cans or glass jars, in syrup or a natural juice. Before sealing, they can be gently heated to remove entrained gases, a process known as exhausting. Filling under vacuum conditions avoids the need for exhausting. The container is then sealed, heat processed and cooled. For fruit, a pasteurising treatment with a temperature under 100 °C is sufficient.

2.2.3.4 Frozen fruit

The freezing of fruits is a major preservation method in its own right and it is widely used to preserve fruits which are to be further processed, e.g. for the manufacture of jam. Fruits intended for freezing are generally washed and inspected before being individually quick frozen (IQF), or packed in syrup or pureed before freezing. Typical fast freezing methods involve direct contact with a cooled solid, e.g. band or drum freezers, direct contact with cooled air or other gaseous mixtures, e.g. blast air, fluidised bed and spiral freezers, direct immersion in a cooled liquid, e.g. brine freezers, or cryogenic freezers. The process for deep-frozen fruit and vegetables is shown in Figure 2.6.

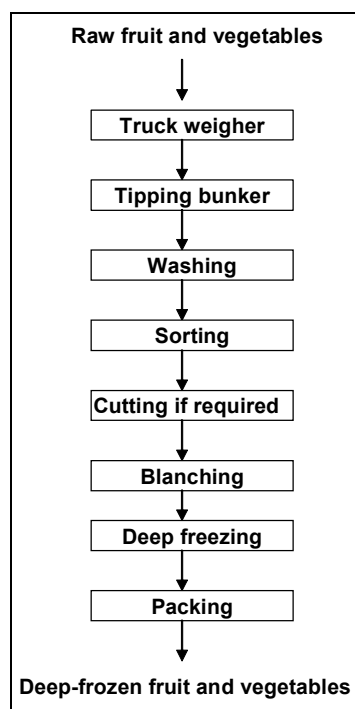

Figure 2.6: The process for deep frozen fruit

2.2.3.5 Fruit preserves

Preserving is the manufacture of jams, jellies, marmalades and mincemeat. It is essentially the combining of fruits and sugar with subsequent cooking. It produces a tasty product of a sufficiently high sugar content, low a_w value, and with a satisfactory shelf-life retention quality. A pasteurising treatment is applied at 85 °C or above. The jams are made using pulp and fruit juice, e.g. citrus for marmalade, and clarified juice for jellies. The basic ingredients of a preserve are fruit, sweetening agents, typically sucrose and/or various sugar syrups; acids, typically citric or malic acid; buffers such as trisodium citrate; fats, in curds/mincemeat; citrus peel, for mincemeat and marmalade; gelling agents, usually pectin and anti-foaming agents – when using frozen or sulphited fruits. In a typical process, the fruit usually arrives pre-prepared either frozen or sulphited. The prepared fruit, pectin, sucrose, glucose syrup and other small ingredients are then blended together in a mixing vessel. The mix is boiled either at atmospheric pressure or under vacuum, using batch or continuous methods. After boiling, the jam is filled into containers which vary from individual portions to bulk tank for bakery use.

2.2.3.6 Dried fruit

Dried fruit processing uses raw materials such as grapes, apricots, pears, bananas and plums. A basic process consists of sorting, grading, washing, drying and packing. Many fruits are sun-dried at source although some producers use mechanical methods, typically tunnels through which hot air is passed. Some fruits are sulphited before drying to preserve the fruit and soften the fruit tissue, leading to a faster loss of moisture during drying. In some cases, the fruit is sprayed or dipped after harvesting with a potassium carbonate solution which also contains dipping oil. The composition of the dipping oil varies between producers. For example, some producers use olive oil, others may use mixtures of ethyl esters of fatty acids and free oleic acid.

2.2.3.7 Tomatoes

In the EU, about eight million tonnes of tomatoes were processed in 2000, of which five million tonnes were processed in Italy. Significant quantities are also processed in Spain, Portugal, Greece and France. The tomatoes are made into different forms for different kinds of products. The main product is 28 to 30 °brix tomato paste obtained from the juice by concentration. Other products are whole, diced or crushed peeled tomatoes, tomato juices such as passata, and dried products such as powder and flakes. The basic processes for tomato manufacturing are shown in Figure 2.7.

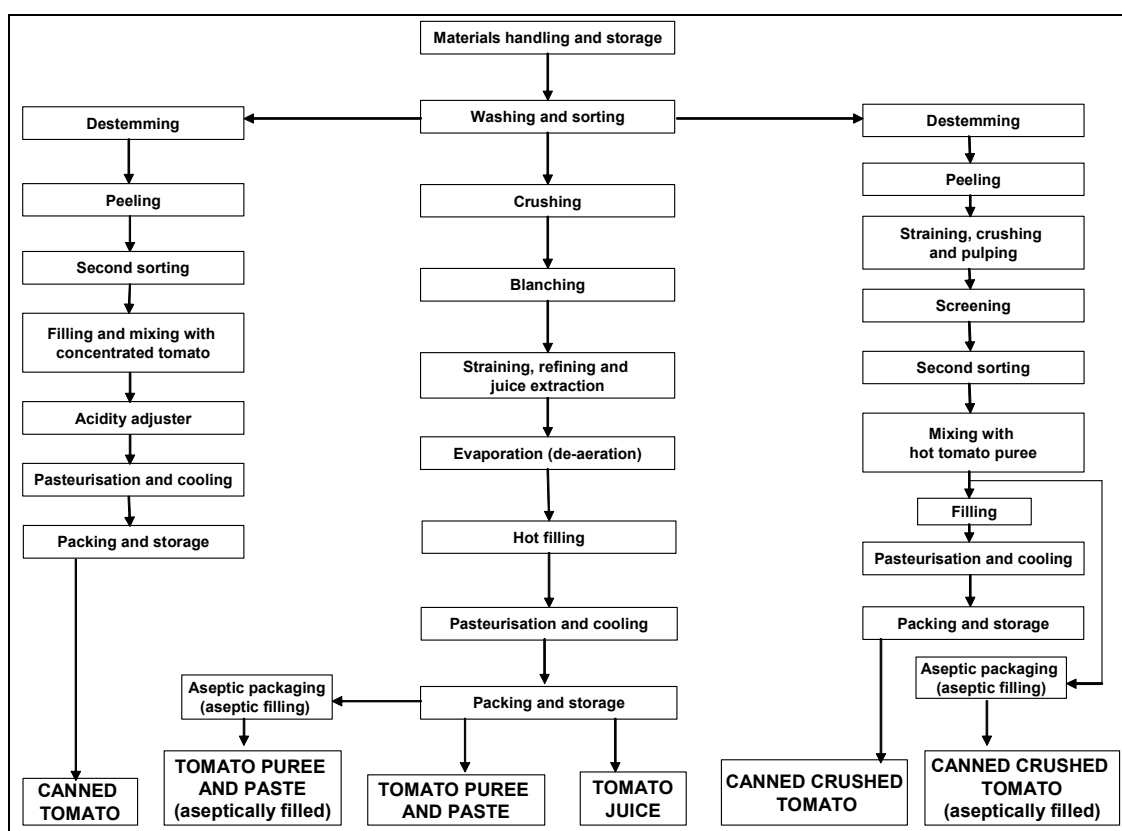

Figure 2.7: Manufacture of various tomato products [91, Italian contribution, 2001]

2.2.3.8 Potatoes

Two of the main potato-based products are crisps and chips. The manufacturing of both essentially consists of peeling the raw material, slicing to an appropriate size and blanching, followed by frying to achieve the desired sensory properties. To prevent colourisation of chips, a substance called pyrophosphate is used in the Netherlands. This is a very significant P-source in the waste water from potato processing installations. Sodium metabisulphate may also be used to prevent potatoes from discolouring. Chips are generally sold frozen and may be part fried or fully fried. Crisps are increasingly sold in modified atmosphere packs.

Whether the product is potato chips, mashed potatoes or another potato product, there may be foam formation in the wash bath, which can lead to serious processing difficulties. Starch foam is very stable and difficult to remove. Mechanical methods of foam control have such limited effectiveness, that the addition of foam-control agents may be the most practical solution [87, Ullmann, 2001].

2.2.3.8.1 Potato chips

Potatoes are delivered to the installation and are sorted to remove stones, pebbles and other extraneous matter. The raw material is washed, graded and peeled. A number of peeling methods are available, including mechanical, steam and caustic peeling. Large tubers are generally sorted for use in chip production. Potatoes are cut into the required size using independently driven multiple knives. Off-cuts, slivers and broken pieces are removed before blanching. The chips are blanched using steam or water generally at around 60 to 85 °C. Multiple blanching stages may be used.

Excess moisture must be removed from the chips both to preserve the life of the frying oil and to lower the moisture content of the chips. This also leads to a reduction in the required frying time. Conveyor driers are used in large processing installations. The chips are fried, typically at around 160 – 180 °C, the time of frying varies for completely fried and partially fried products. Excess fat is removed from the chips before freezing. Some manufacturers recover the fat for re-use. Fluidised bed freezing may be used for freezing the finished product, although belt freezing reportedly provides a more energy efficient option.

2.2.3.8.2 Potato crisps

Processing methods for the manufacture of crisps vary greatly, but generally take the form of washing, peeling, trimming and sorting, slicing, rinsing, partial drying, frying, salting, flavouring, cooling and packing. Potatoes are first washed with drum or flotation washers. Stones, sand, dirt and any extraneous matter are removed. Potatoes are elevated into washers and peeled by abrasion. Peeled potatoes are trimmed to remove eyes, bruises and decaying portions. Slicing is carried out using a series of blades mounted on a circular stationary plate and a rotating drum. Water is supplied to flush starch from the equipment. Sliced potatoes are washed, usually in drum washers, to remove surface starch and sugars.

Some manufacturers blanch crisps prior to frying using steam-jacketed water filled tanks. Typical blanching conditions are 65 to 95 °C, for one minute or more. After washing, surface moisture is removed by various methods including compressed air and blower fans, vibrating mesh belts and heated air. Crisp frying may be batch or continuous. Temperatures are in the range of 160 to 190 °C and cooking times are typically between 1.5 and 3 minutes. When the crisps leave the fryer, they are agitated to remove excess oil and discharged to a belt running underneath a salter. Flavouring may be mixed with the salt or dusted/sprayed onto the crisps in rotating drums. Finally the crisps are cooled and packed.

2.2.3.9 Vegetable juice

Significant quantities of juice are produced from vegetable sources such as carrot, celery, beetroot and cabbage. In general, fresh vegetables are first washed and sorted before being coarsely milled and then pressed to extract the juice. Most vegetable juices have low acidity, i.e. a pH >4.5, and therefore, they require a full sterilisation process for preservation. Vegetable juices are sometimes acidified with organic or mineral acids to reduce the pH, so that a milder heat treatment such as pasteurisation is then possible. Some low acidity juices are blended with high acid juices such as tomato, rhubarb, citrus, pineapple or cabbage, so that they are acidic enough to only require pasteurisation. Some vegetables may be blanched prior to acidifying and extraction. Root vegetables are usually peeled before maceration and extraction.

2.2.3.10 Heat treated and frozen vegetables

Process conditions vary depending upon the vegetable type, but preliminary operations for both heat treated and frozen vegetables are similar to those described in Section 2.2.3.3 for fruits. They usually involve washing, grading and screening to remove extraneous matter such as stones and dirt. After washing, the vegetables are peeled and may be trimmed. After peeling the vegetables may be left whole or cut in a number of ways such as sliced or diced. Some vegetables are washed after slicing to remove the surface starch. Most vegetables require blanching. Steam or water blanching are the most common methods. The product is then cooled rapidly. After cooling, the product may be re-inspected and screened before being quick frozen or filled into cans or glass jars, usually with a hot brine, e.g. sugar, salt or acid, and then heat processed. Vegetables generally undergo a full sterilisation process as the pH is too high to inhibit microbial action.

2.2.3.11 Pickling of vegetables

In a typical pickling process, raw vegetables are delivered, washed and then screened to remove extraneous matter such as stones. Depending upon the vegetable, the raw material might be steam cooked and then cooled. The product is then peeled, typically using steam, and re-inspected before being cut to the required dimensions, e.g. sliced/diced/shredded, and transported to the filling line. The chopped vegetables are then filled into containers. An acidifying liquor is mixed with spices and transferred to the filling line to be used in the pickling sauce. This liquor typically consists of acetic acid, malt vinegar, spirit vinegar, distilled malt vinegar, liquid sugar and salt, depending upon the formulation. The acidifying liquor is deposited into the container. The container is sealed and typically pasteurised before cooling and packaging.

2.2.3.12 Vegetable drying

Vegetable drying uses raw materials such as potatoes, tomatoes, mushrooms and onions. The basic process is the same as in fruit processing, i.e. sorting, grading, washing, drying and packing. Many vegetables can be sun dried at source. Mechanical methods can also be used.

2.2.4 Vegetable oils and fats

Oils and fats occur naturally in a wide range of sources, although only around 22 vegetable oils are processed on a commercial scale around the world. These are summarised as:

- production of oils from oilseeds, i.e. sunflower seed, soya bean, rapeseed, safflower seed, mustard seed, cotton seed and ground nuts
- production of oils from fruit pulp, e.g. olives
- production of animal fats
- production of fish-oils.

Oils produced in the largest quantities come from soya beans, ground nuts, olives, sunflower seeds, safflower seeds, cotton seeds, mustard seeds and rapeseeds; the latter is also known as colza oil. Mediterranean countries produce 95 % of the total world olive oil production estimated to be 2.4 million tonnes per year. Animal fats for human consumption are generally produced by a process known as fat melting and by fish-oil production. Animal fat and fish-oil production is within the scope of the “Slaughterhouses and animal by-products BREF” [181, EC, 2003].

The preparation of raw materials includes husking, cleaning, crushing, and conditioning. The extraction processes are generally mechanical, e.g. boiling for fruits and pressing for seeds and nuts, or involve the use of solvents such as hexane. After boiling, the liquid oil is skimmed. After pressing, the oil is filtered. After solvent extraction, the crude oil is separated and the solvent is evaporated and recovered. Residues are conditioned, e.g. dried, and are reprocessed to yield by-products such as animal feed. Crude oil refining includes degumming, neutralisation, bleaching, deodorisation, and further refining. Oils can be processed further to produce margarine.

2.2.4.1 Seed oil extraction

The production of crude vegetable oil from oilseeds is a two-step process. The first process step involves the cleaning, preparation, i.e. drying, dehulling, flaking, conditioning and pressing of the oilseeds. Pressing takes place in one or two steps resulting in a crude pressed oil and a cake with an oil content of 12 to 25 %. No subsequent hexane extraction takes place, if the oil content of the cake after pressing is only reduced to between 6 and 12 %. Beans with 20 % oil or less are not pressed, because of their lower fat content, but are extracted directly after cleaning and preparation.

The second process step includes extraction of the oil from the pressed cake or flaked beans with hexane. The extraction takes place in a countercurrent flow. The mixture of hexane and oil, called miscella, is further processed in a distillation process to recover the hexane from the vegetable oil. The solvent is passed through a hexane/water separation technique and then re-used in the extraction process. The remaining hexane in the cake is recovered by a stripping process, using steam. This desolventising/toasting process also reduces the enzyme and micro-organism activity in the meal. The hexane/steam vapours are used in the miscella distillation process for solvent and heat recovery. The meal is dried and cooled by air before being stored in silos or before loading.

There are a variety of manufacturing methods associated with the large range of oil sources which release oil and improve subsequent extraction. A number of key steps are typically always undertaken. Coarse extraneous matter such as wood, stones and metal are first removed with, e.g. sieves or magnets. Fine impurities such as plant residues, dust and sand are then removed, e.g. by vibrating sieves, wind sifters and cyclones. The husks and hulls of seeds, such as soya and sunflowers, are removed, and the seeds are then cracked, followed by air classification, to expose the flesh of the raw material. After this, the flesh is conditioned or dried to a required moisture level, typically 9 to 10 % and rolled into flakes.

2.2.4.2 Refining of edible oils and fats

Refining removes undesirable compounds such as gums, ffa, pigments, undesirable flavours and odour compounds. In general, there are two ways to refine seed oils, i.e. physical refining and the more conventional chemical refining. Conventional chemical refining, as applied to crude oils for instance, includes degumming for the removal of phospholipids, neutralisation for the removal of ffa and bleaching for decolourisation and deodorisation.

Degumming involves the addition of water to hydrate any gums present, followed by centrifugal separation. Non-hydratable gums are removed by converting them first to a hydratable form using phosphoric or citric acid, followed by the addition of water and centrifugation.

The next step is neutralisation in which an aqueous alkali, typically caustic soda or sodium carbonate, is splashed into the oil which has been preheated to around 75 to 95 °C. The alkali reacts with the ffa in the oil to form soaps, which are separated by sedimentation or centrifugation. A drying step may be incorporated after neutralisation to ensure the complete removal of the added water.

The neutralised oil is bleached to remove colouring matter, such as carotenoids and other minor constituents, such as oxidative degradation products or traces of transition metals. Bleaching uses activated Fuller's earth with treatments typically in the 90 to 130 °C range for 10 to 60 minutes. The earth is sucked into the oil under vacuum and is removed by filtration.

The bleached oil is steam distilled at low pressure to remove volatile impurities including undesirable odours and flavours. This process, known as deodorisation, takes place in the temperature range of 180 to 270 °C and may last from 15 minutes to 5 hours depending upon the nature and the quantity of the oil, and the type of equipment used. For example, if a batch deodoriser is used, it would take between 4.5 to 5 hours depending on the oil type and the quantity. However, if the same oils were processed in a semi-continuous deodoriser it would take about 15 minutes. Figure 2.8 shows a flow diagram of crude oil chemical refining. Olive oil and husk from pomace oil refining is similar to oilseed oil refining.

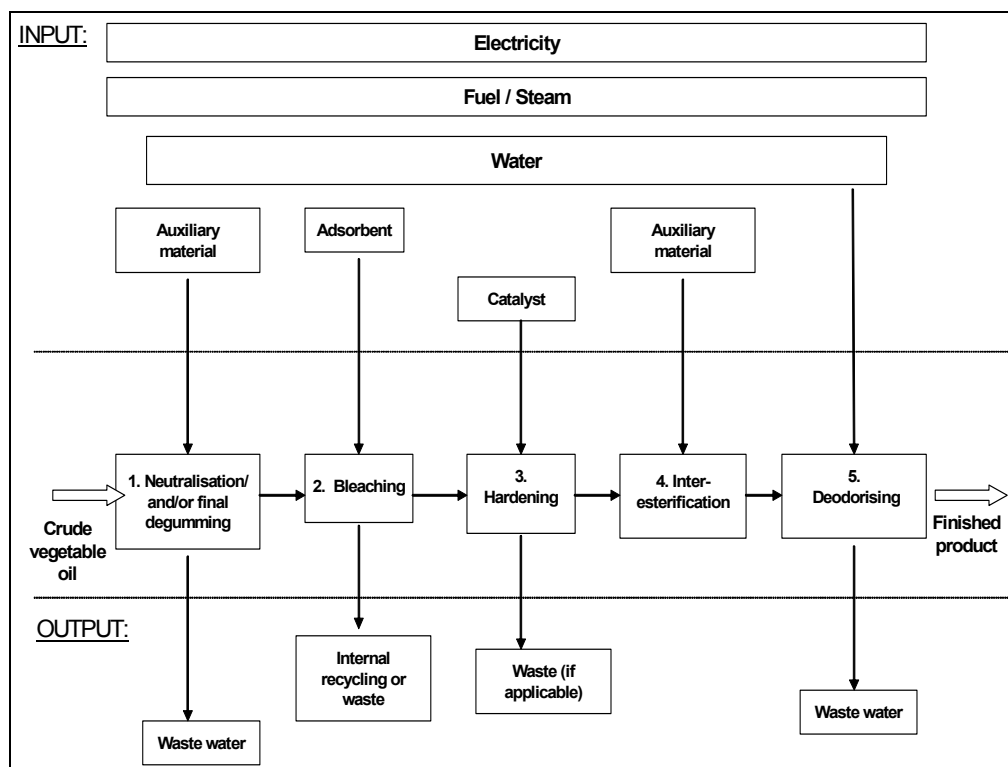

Figure 2.8: Crude oil chemical refining
[79, Italian contribution, 2001]

Physical refining is a simpler process in which the crude oil is degummed and bleached, followed by steam stripping which removes ffa, odours and volatiles in one step. The oil is heated to temperatures of up to 270 °C and then refined by the oil flowing over a series of trays countercurrent to the flow of the stripping steam. The advantages of physical refining are the higher yield, the lower cost and the fewer chemicals used. One of the disadvantages, compared to chemical neutralisation, can be a lower quality of the end-product.

There are three other processes which may be carried out during oil refining, depending upon the oil source. These are winterisation, which essentially is the removal of wax which would otherwise cause cloudiness. This is carried out on, e.g. sunflower oil. The process involves cooling the oil followed by filtration, using a filter aid to remove wax. The second process is fractionation. Typically this may be carried out on crude or refined oil. This involves completely melting the solid oil, followed by cooling to yield solid and liquid fractions which have different functional properties (see Section 2.2.5.3.). The third process is interesterification. This involves the separation of triglycerides into fatty acids and glycerol followed by recombination. The reaction is carried out using citric or phosphoric acid plus a catalyst, typically sodium methoxide. Interesterification modifies the functional properties of the treated oil and may be carried out after neutralisation or deodorisation.

2.2.4.3 Crystallisation of edible oils and fats

Crystallisation of edible oils and fats, also called fractionation, is based on the principle that the solubility of the higher melting components in the liquid phase change at different temperatures. This difference can be extended by using an organic solvent which has the effect of decreasing the viscosity and leading to better washing of the crystals.

The equipment includes tanks for preheating; stirred and cooled tanks for crystallisation; band or membrane filters for the separation of the crystals from the liquor and distillation vessels for solvent recovery. The oil is heated to 10 °C above the melting point of the highest triacylglycerol present, to give a fully liquid starting material, e.g. the heating point is typically 75 °C for palm oil. The molten oil is then cooled and stirred to form crystal nuclei, and the temperature is maintained at a lower temperature to induce crystal growth, typically for 12 hours at 28 – 30 °C for palm oil. If a solvent is used, it is added to the molten oil prior to cooling. The mixtures containing the crystallised solids and the dissolved liquids are separated by filters. If a solvent is used, it is removed from the fractions by distillation.

2.2.4.4 Further processing of edible oils and fats – margarine

The main products manufactured from edible oils and fats are margarine, edible fats, edible oils and mayonnaise. In view of its major outstanding importance, only margarine production is described here.

Most installations carry out hydrogenation to produce fats with superior retention qualities and higher melting points. Hydrogenation is usually carried out by dispersing hydrogen gas in the oil, in the presence of a finely divided nickel catalyst supported on diatomaceous earth. The resultant hydrogenated fats are filtered to remove the hydrogenation catalyst, subjected to a light earth bleach and deodorised before they can be used for edible purposes. After hardening, the oil is mixed with an aqueous solution to produce an emulsion. The emulsified mixture is then pasteurised, cooled and crystallised to obtain the final product.

2.2.4.5 Olive oil

The words “olive oil” mean the product obtained from *Olea europea*. It is composed of about 98 % glycerides with the remaining 2 % being various components naturally present in olives, some of which play a fundamental role in the olfactory and taste characteristics and which are also important for the stability and quality of the product. Olive oils and husk oils are classified on the basis of denominations and definitions from Regulation 136/66/EEC of 22 September 1966 on the establishment of a common organisation of the market in oils and fats [215, EC, 1996].

Extra virgin oils, virgin oils and ordinary virgin oils are edible; yet only extra virgin oils and virgin oils can be commercialised as they are for direct consumption. Ordinary virgin oils are commonly used mixed with refined olive oils and refined husk oils. Acid oils with an acidity higher than 3.3 degrees must be refined.

The quality of the olive oil depends on the ripeness of the olives, the type of harvesting, e.g. picking or shaking, the type of intermediate storage, and the type of processing carried out. Olives contain 38 to 58 % oil and up to 60 % water. Ripe olives should be processed as quickly as possible since lipases in the pulp cause rapid hydrolysis of the oil, impairing its quality for edible purposes. Top-grade oils are made from fresh, handpicked olives by size reduction, pasting, and cold pressing. In the production of olive oil, there are three systems currently in use for the extraction of the oil; traditional, by pressing; three-phase separation or two-phase separation.

In traditional production of olive oil, olives are ground into a paste with stone mills, however these days modern milling equipment is also used. Milling is followed by mashing, possibly with the addition of salt. The pulp is then pressed and the press oil is clarified by sedimentation or centrifugation. Traditional open-cage presses are now being replaced by continuous screw expellers. The mashed pulp can also be separated in a horizontal decanter, in which case the crude oil is re-centrifuged after the addition of wash-water. Alternatively, machines can be used to remove the kernels from the pulp and the residue is then separated using self-discharging centrifuges. Cold pressing, which yields virgin grades, is generally followed by a warm pressing at approximately 40 °C. Cold-pressed olive oil is a valuable edible oil.

In Spain, most installations use the two-phase type centrifuges, while in most other Mediterranean countries larger installations use the three-phase technique, and smaller installations typically still use traditional pressing. While the two-phases generate a paste-like waste, both the traditional and the three-phase systems produce a liquid phase, i.e. olive mill waste water, or alpechin and a press cake known as pomace, husk, or orujo. This latter product may be further treated as husk or pomace oil. The remaining solid husk is dried to 3 – 6 % of humidity and used as fuel. Olive kernel oil is obtained by pressing and solvent extraction of cleaned kernels. It is similar to olive oil but lacks its typical flavour.

Trade specifications are based primarily on the content of ffa and flavour assessment. In some countries, warm-pressed olive oil with a high acidity is refined by neutralisation, bleaching, and deodorisation, and flavoured by blending with cold-pressed oil. The press cake contains 8 to 15 % of a relatively dark oil, called sanza or orujo, which can be extracted with hexane and is used for technical purposes. After refining, it is also fit for edible consumption.

2.2.4.6 Olive-pomace oil

Olive-pomace installations process the olive-pomace remaining after the extraction of oil from the olives. Oil is extracted with solvents resulting in crude pomace oil and exhausted husks. Oil is sent to refineries and later used in the food industry, while exhausted pomace is mainly used as fuel. Refined olive-pomace oils are mixed with virgin oils different from the lampante oils. It is also classified on the basis of denominations and definitions from Regulation 136/66/EEC [215, EC, 1996].

2.2.5 Dairy products

Milk is approximately 87 % water, with the remainder being protein, fat, lactose, calcium, phosphorus, iron and vitamins. Cows milk is primarily consumed, but goats and sheep milk are also consumed in significant quantities. A number of dairy products such as cream, cheese and butter are produced from milk.

2.2.5.1 Milk and cream

Raw chilled milk is received at the dairy and transferred to bulk storage. The milk may be centrifugally separated to produce skimmed or semi-skimmed milk and a cream stream. The milk is then heat treated by a variety of methods such as pasteurisation or sterilisation, also known as UHT. Heat processing may be a batch or continuous operation depending upon the quantity of the milk to be processed and the method employed.

The milk is first homogenised. Homogenisation disperses fat globules and prevents separation of the cream component. To achieve a sufficient creaming stability for pasteurised milks with a relatively short shelf-life, reduction of the fat globules size to a mean diameter of 1 to 2 μ is required, while the long shelf-life UHT milks require a much greater reduction in fat globule size, $\leq 0.7 \mu$.

Another effect of homogenisation is the large increase in exposed fat area, which greatly favours the action of lipases. For this reason, it is normal practice to pasteurise the milk to inactivate the lipase, immediately after homogenisation. Figure 2.9 shows a flow sheet for a short time pasteurised milk process.

Typical heating parameters for a continuous pasteurisation process are 72 °C for 15 seconds. This is known as high temperature short time pasteurisation (HTST). Hot milk is often used to partially heat incoming cold milk in a heating step known as regeneration. Following pasteurisation, the milk is rapidly cooled to <7 °C. Milk which is not in-container heat processed, is filled and sealed in containers under clean or aseptic conditions. Incoming milk may be homogenised after the regeneration stage, before being pasteurised.

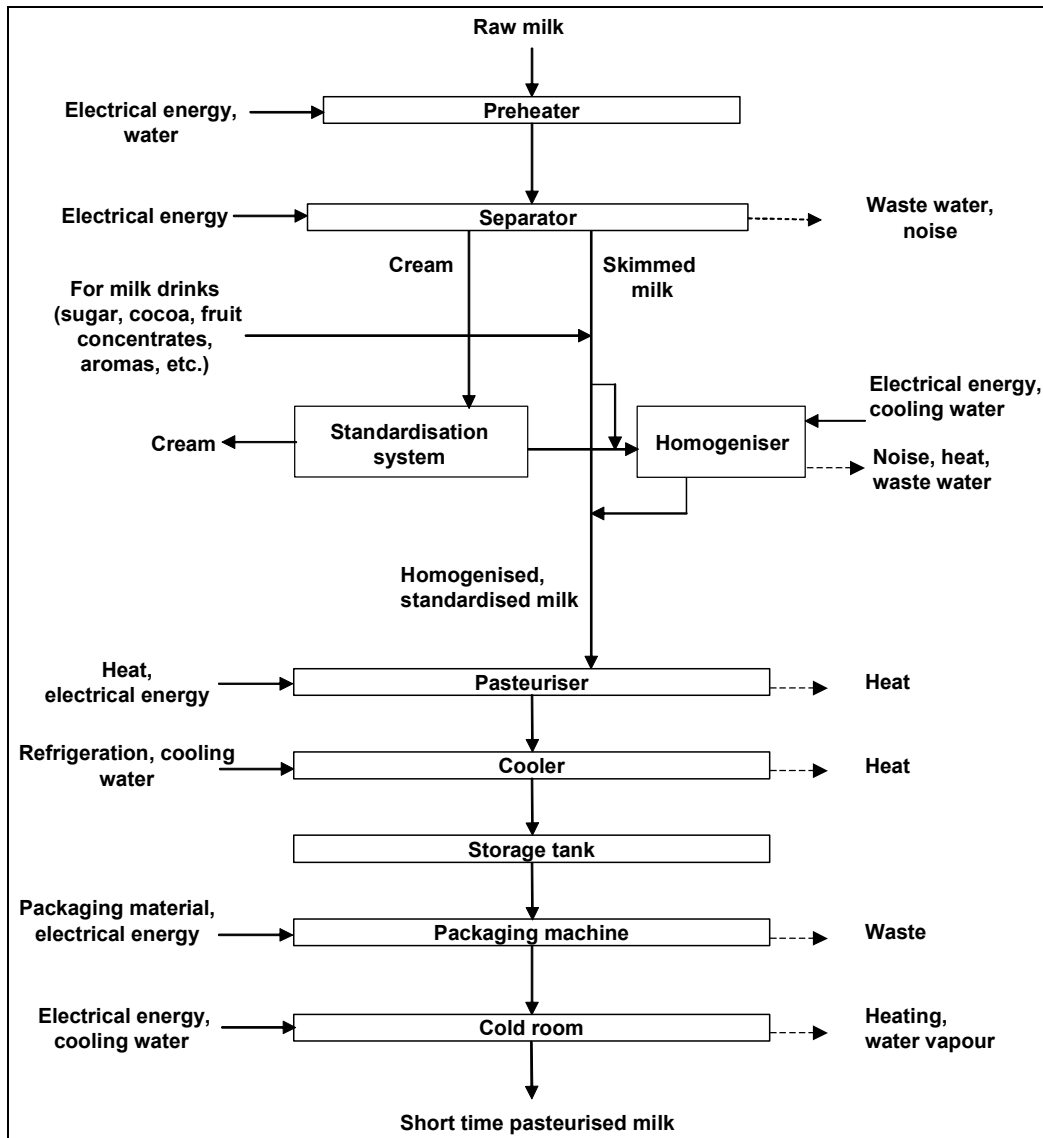

Figure 2.9: Short time pasteurised milk process [79, Italian contribution, 2001]

UHT or sterilisation is used to increase the shelf-life of the product. Continuous UHT at a minimum of 135 °C for one second is carried out. This can be done in two different ways. Heating it indirectly, using heat-exchangers with various types of plates and pipes or in two stages, i.e. first heating the milk indirectly to approximately 80 °C and then heating it directly by mixing steam and milk. The ratio of the weight of steam and milk used is approximately 1:10. If direct heating is applied immediately after the heat treatment, the milk is then cooled by expanding it under a vacuum to extract the steam mixed with the product in the sterilisation phase. This is also called flash cooling. The end temperature of the milk immediately returns to its level prior to mixing with the steam. Cooling by indirect exchange with a coolant or countercurrently with the incoming product, then follows. Figure 2.10 summarises the production of UHT milk.

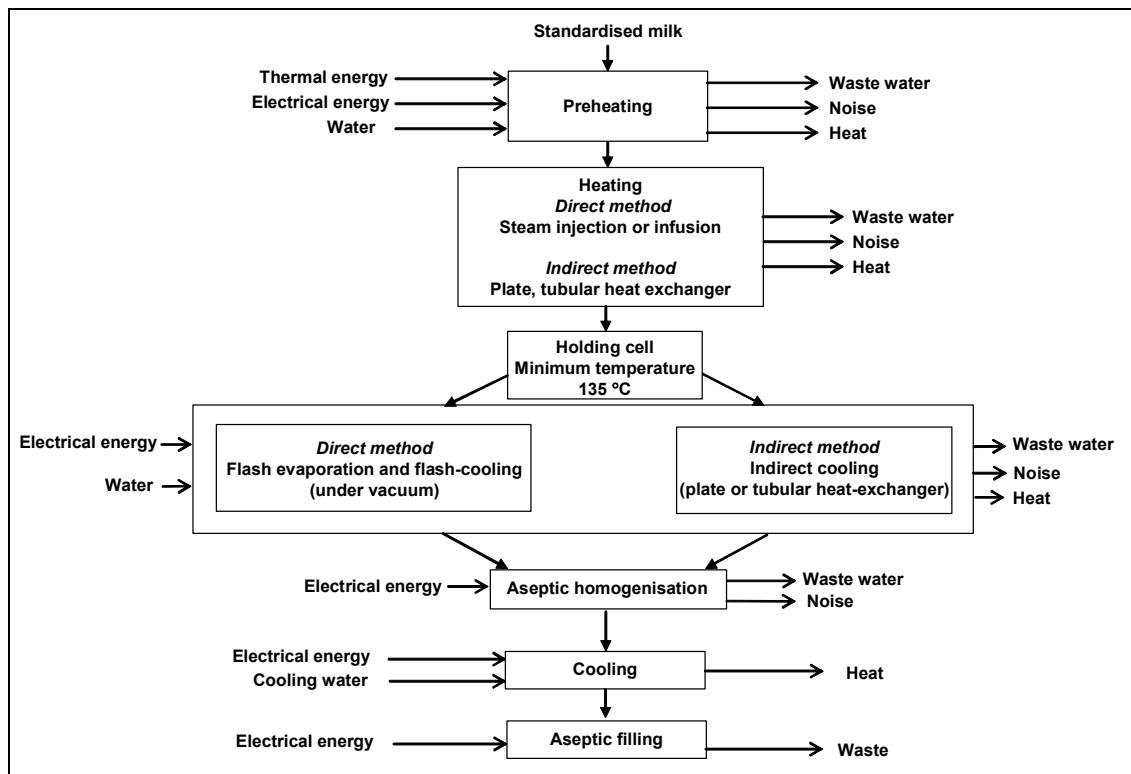

Figure 2.10: Production of UHT milk
[79, Italian contribution, 2001]

The heat treatment for long-life sterilised milk consists of two phases. The first phase is a continuous heat treatment or pre-sterilisation, similar to that described for UHT treatment. The second phase consists of the final treatment of the closed container after filling and sealing the pre-sterilised product. The second heat treatment generally takes place in an autoclave in batches or in a continuous retort at approximately 110 to 125 °C for 20 to 40 minutes with an end phase of sprinkler cooling. Long-life sterilised milk and other dairy products are packaged in closed containers such as plastic or glass bottles. Figure 2.11 summarises the production of sterilised milk.

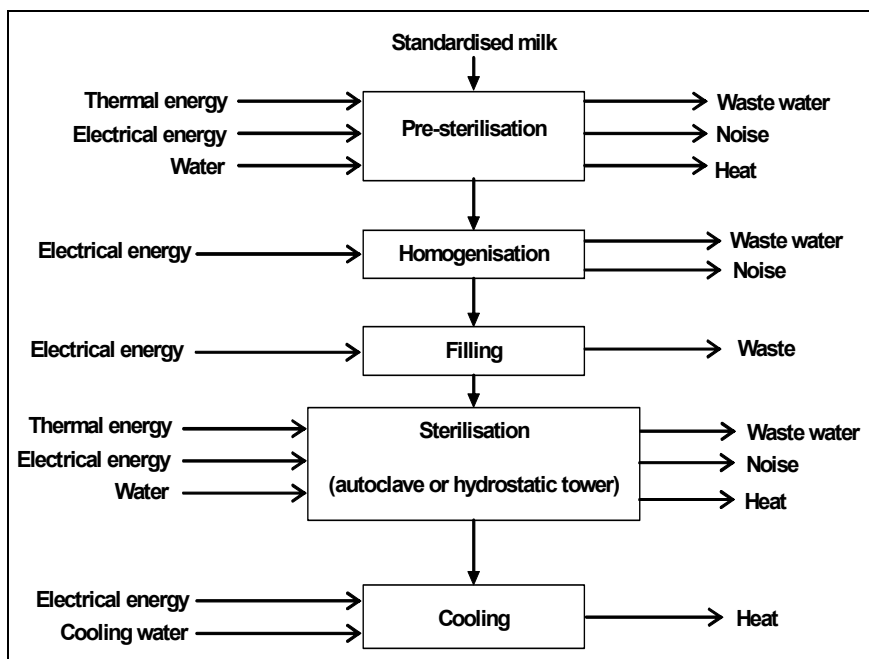

Figure 2.11: Production of sterilised milk
[79, Italian contribution, 2001]

2.2.5.2 Condensed and powdered milk

The first stage in the production of condensed and powdered milk is the concentration of the raw milk. Homogenised milk is usually concentrated with evaporators. Falling film evaporators are generally used followed by a drying step using a spray drier (see Section 4.2.9). Alternatively, RO can be used to mechanically remove some of the water from the milk, without the application of heat. Electrical power is used to pump liquid through a semi-permeable membrane to increase the concentration of solids. Doubling of the concentration of milk and whey is common [39, Verband der Deutschen Milchwirtschaft (German Dairy Association), 2001]. The powder is typically agglomerated to improve reconstitution. Dry whole milk is susceptible to oxidative rancidity and may be packaged in a protective atmosphere to extend its shelf-life. These processes are shown in Figure 2.12 and Figure 2.13.

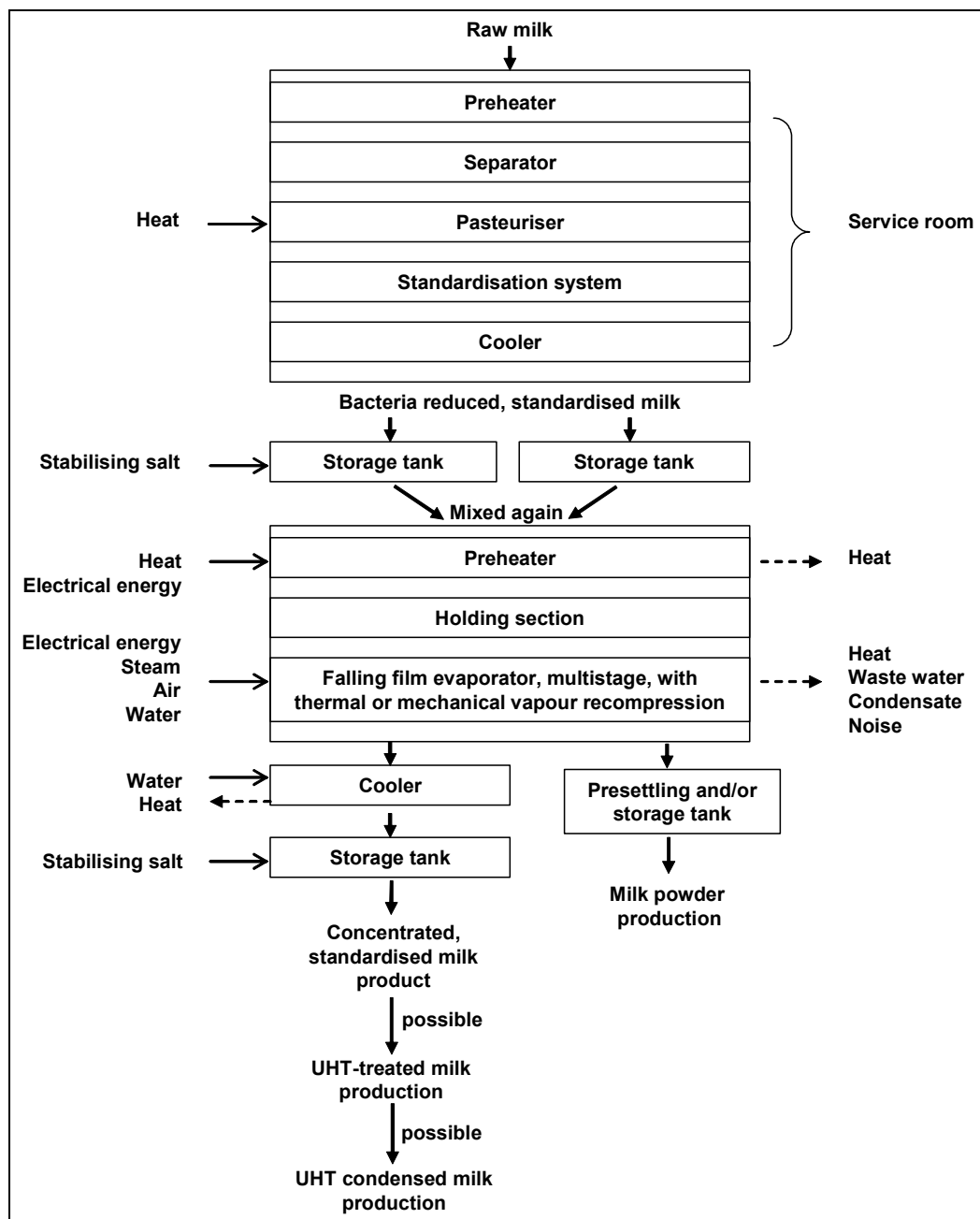

Figure 2.12: Flow sheet of processes for condensed products (e.g. UHT condensed milk) and intermediate products (e.g. milk concentrates)
 [9, Verband der Deutschen Milchwirtschaft (German Dairy Association), 1999]

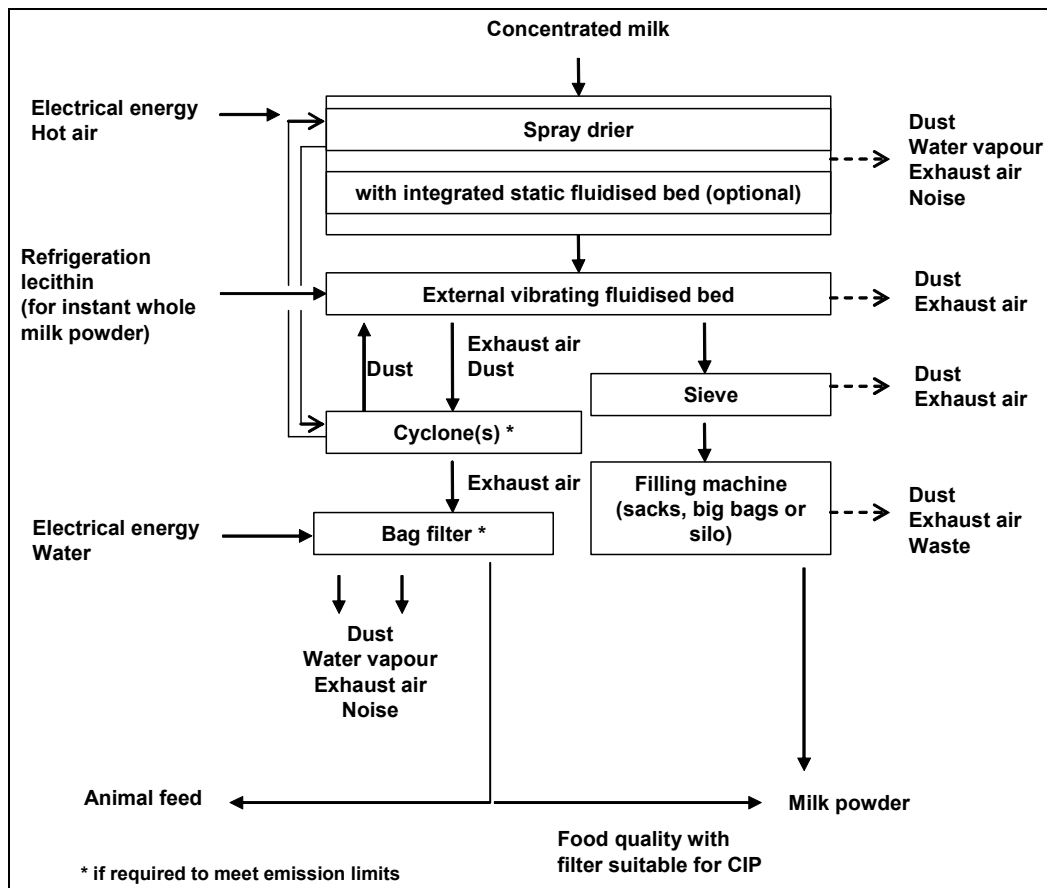

Figure 2.13: Flow sheet of powdered milk production [9, Verband der Deutschen Milchwirtschaft (German Dairy Association), 1999]

2.2.5.3 Butter

Butter is produced from cream which is centrifugally separated from pasteurised milk. The cream contains around 35 to 40 % milk fat. The process is basically a mechanical one in which cream, an emulsion of oil in water, is transformed to butter, an emulsion of water in oil. This is achieved by a process of batch or continuous churning. Cream is rapidly chilled and held at that temperature for a set period in a process known as ageing. The cream is then subjected to churning and working. Churning agitates the cream to partially break down the oil in the water emulsion until fat globules bind together to produce butter grains. The liquid phase called buttermilk is removed and the butter grains are washed in water. Salt may be added before the working stage of the process begins. This involves slow agitation of the grains, subjecting them to a kneading and folding action. The butter is packaged and stored, typically in chilled or frozen storage. A number of continuous techniques are available such as methods in which cream is subjected to high speed churning and continuous working. Figure 2.14 summarises continuous buttermaking.

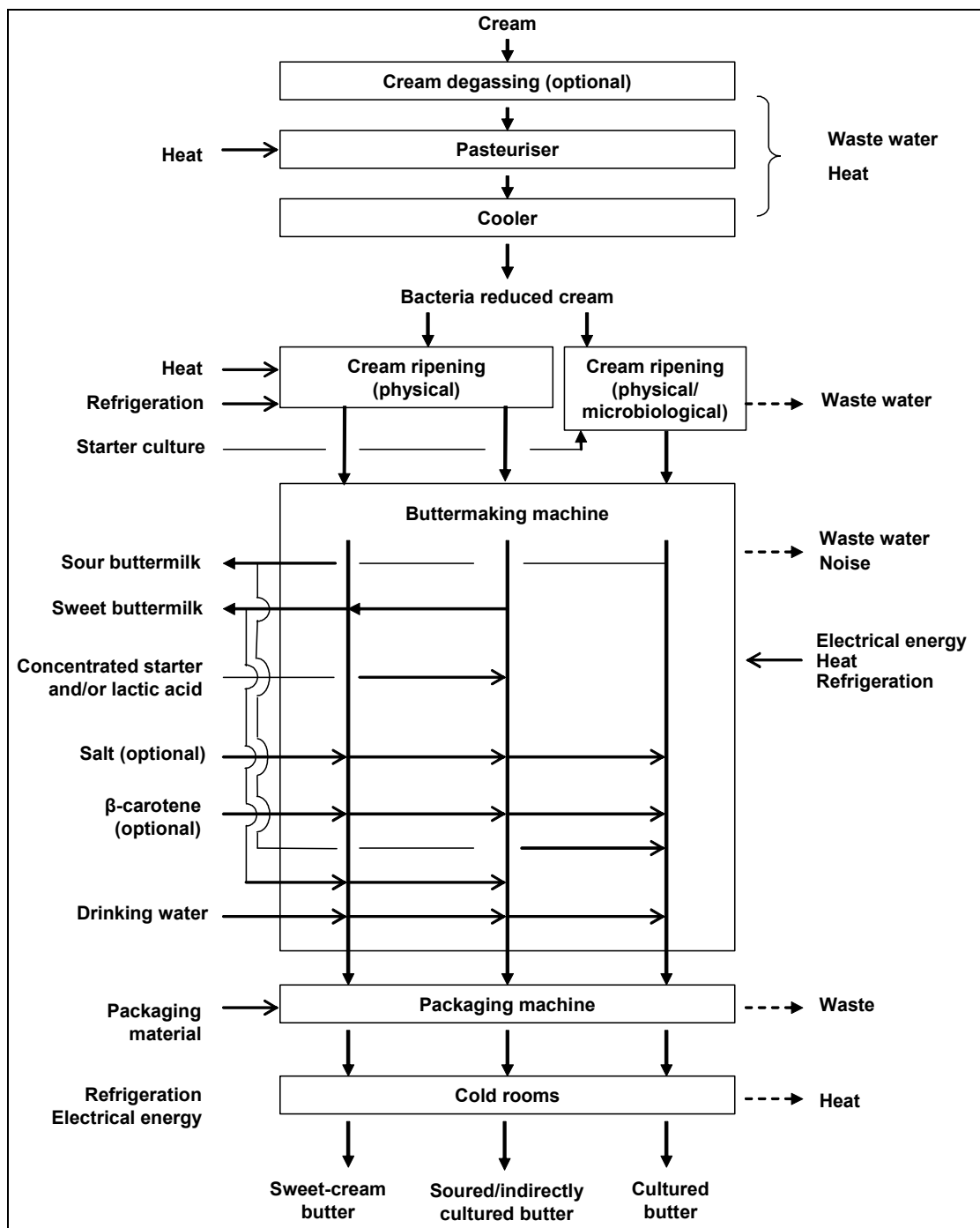

Figure 2.14: Continuous buttermaking
[9, Verband der Deutschen Milchwirtschaft (German Dairy Association), 1999]

2.2.5.4 Cheese

There are a very wide range of cheese varieties and many subtle differences in processing methods. In general, however, the following process steps apply; production of a coagulum through the action of rennet and/or lactic acid, separation of the resulting curds from the whey, and manipulation of the curds to produce the desired characteristics of the cheese.

The traditional manufacture of cheese is a manual process but modern processes are highly mechanised. Starter cultures are added to the milk to produce lactic acid and rennet is then used to coagulate the milk protein. The curds and whey are separated and the curds washed and cut into cubes. Texturising of the cheese involves compressing and stretching the curds and can be carried out in tower systems. The curd blocks are milled, salt is added, and the curds are pressed. Pressed cheese is wrapped to protect it against moisture loss and mould growth during storage. Cheese is matured to develop flavour and texture in temperature and humidity controlled stores, with regular turning of the cheese surface. Figure 2.15 shows a flow sheet of the manufacture of cheese.

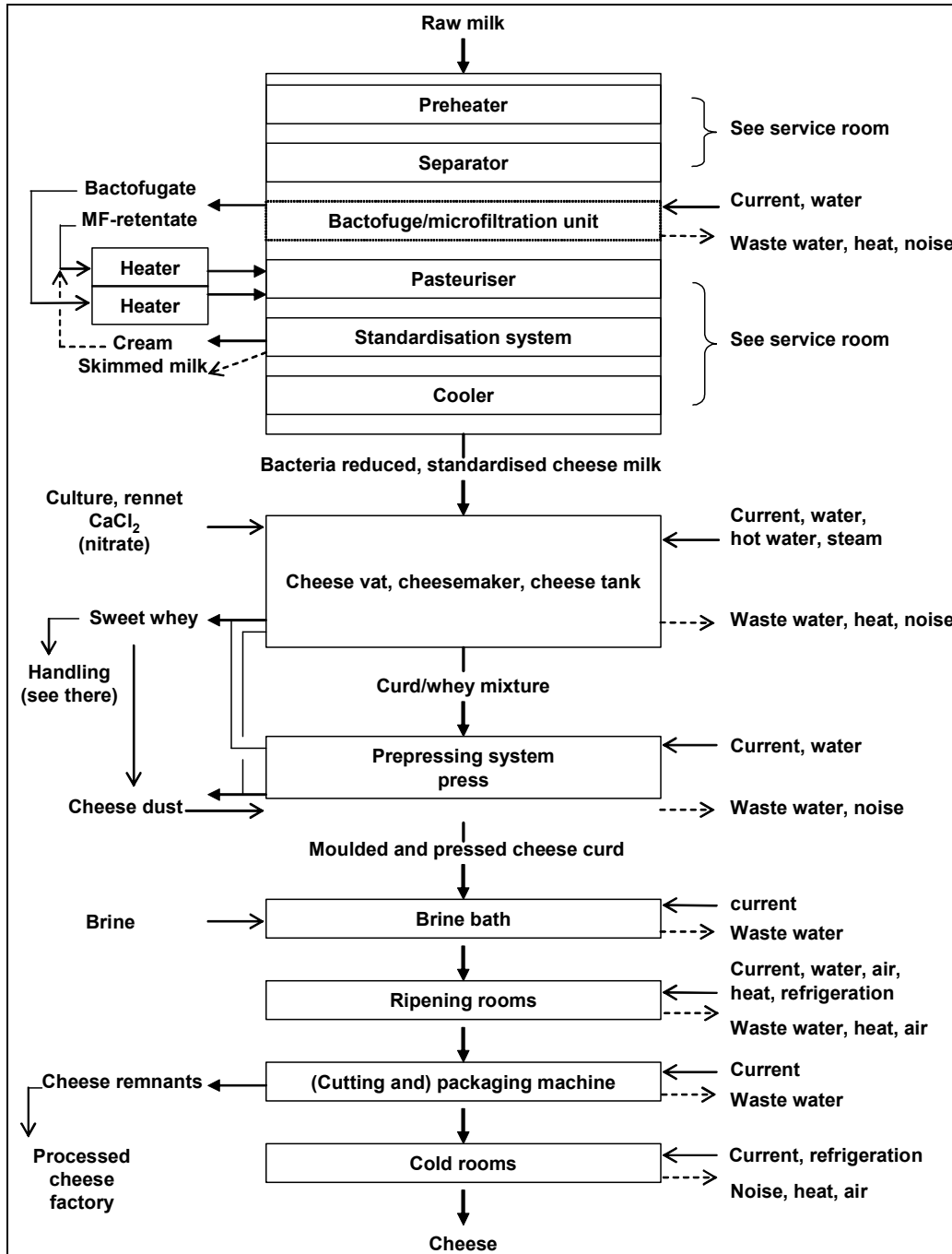

Figure 2.15: Manufacture of cheese [9, Verband der Deutschen Milchwirtschaft (German Dairy Association), 1999]

A further process involves melting. Milled cheese and other ingredients are put into a processing kettle and heated to a temperature normally not less than 75 °C to ensure a complete pasteurisation of the processed cheese. Agitation during processing is important for a complete emulsification of the processed cheese. The temperature and duration of the process depends on the type of processed cheese aimed for and the nature of the raw cheese.

2.2.5.5 Yoghurt

Yoghurt is a fermented milk product which differs from cheese in that rennet is not added and thickening occurs as a result of acidification by lactic acid bacteria. The main ingredients of yoghurt include milk; milk powders or concentrated milk or ultra-filtered milk, and stabilisers, such as modified starches. Most of the yoghurt produced is manufactured in bulk before the addition of fruit and/or flavourings.

The main steps in the manufacture of yoghurt are as follows. The fat and non-fat solids content of the milk is first increased by the addition of milk powders. Stabilisers may be added at this stage. The milk is then homogenised at a temperature of around 55 °C and heat treated at 80 to 90 °C for 30 minutes in a batch process, or 90 to 95 °C for 5 minutes in a continuous process. The heat treated milk is then cooled to around 40 to 43 °C and seeded with two starter organisms – *Streptococcus salivarius* subspecies *thermophilus* and *Lactobacillus delbrueckii* subspecies *bulgaricus*. Fermentation takes around 4 hours. At the end of the process, the product is cooled to 15 – 20 °C, using either tank cooling coils or, more commonly, tubular or plate heat-exchangers. Fruit and flavours are blended into the yoghurt which is then cooled to less than 5 °C and filled into pots ready for storage and distribution. Figure 2.16 shows the yoghurt production process.

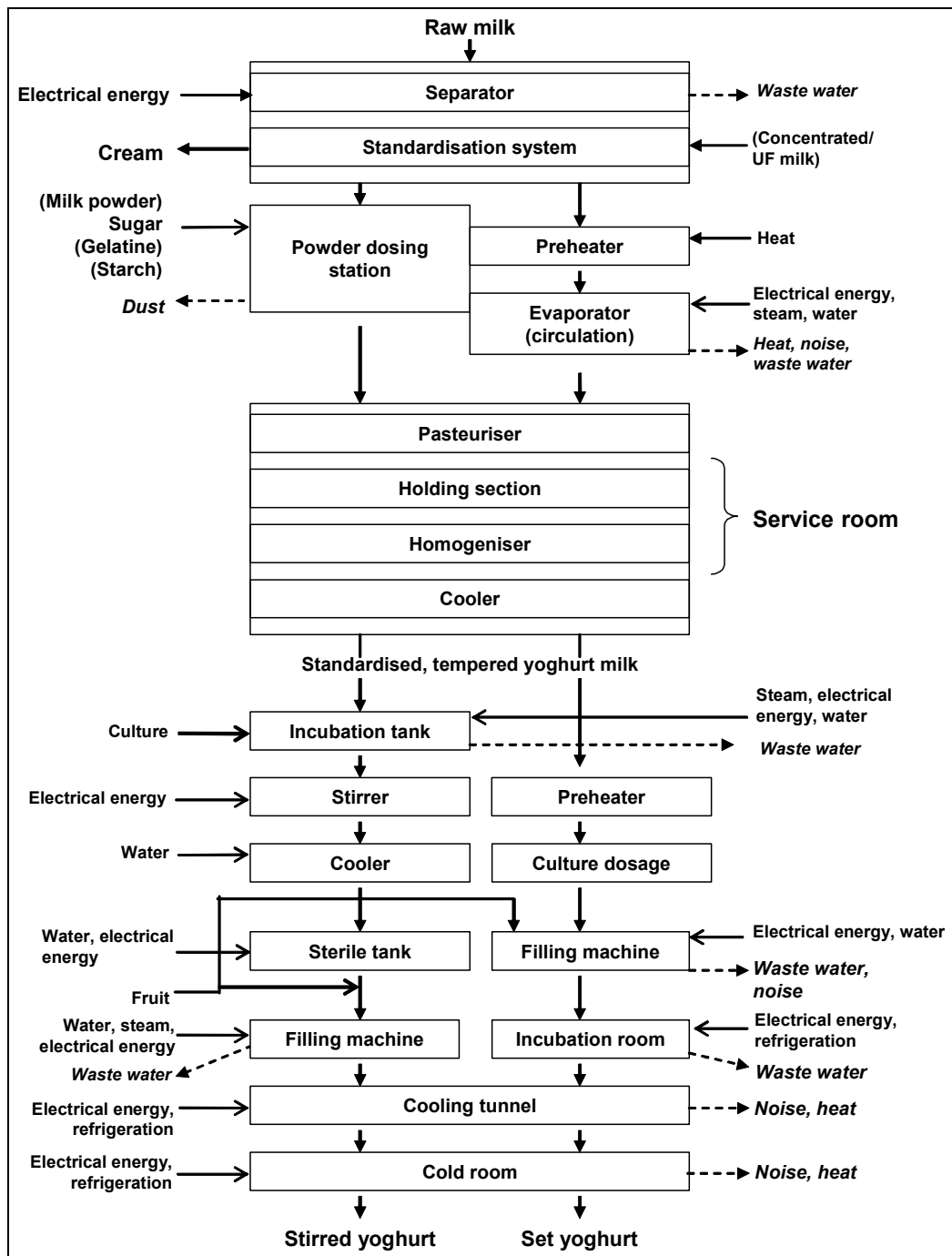

Figure 2.16: Yoghurt production
[9, Verband der Deutschen Milchwirtschaft (German Dairy Association), 1999]

2.2.5.6 Ice-cream

Ice-cream is a dairy based product which typically contains 6 to 12 % fat, 7.5 to 11.5 % non-fat milk solids, and 13 to 18 % sugars. Stabilisers, emulsifiers, colours and flavours are also added. Sugar is usually added as sucrose, and the non-fat milk solids are usually from skimmed milk solids. The fat source may be milk, cream, butter or butter oil. Most ice-cream contains vegetable fat. The ingredients are blended, heated to around 70 to 75 °C and homogenised. The mixture is then pasteurised by heating to 80 – 85 °C for 2 to 15 seconds before cooling and ageing by holding at chilled temperatures for 4 to 24 hours.

Colours and flavours are added at the ageing stage. Continuous freezers are used to rapidly freeze the ice-cream down to around $-6\text{ }^{\circ}\text{C}$, with compressed air being introduced into the ice-cream during the freezing process. The increase in volume due to the addition of air is known as over-run. The ice-cream is filled into containers and frozen further in tunnel freezers operating at -30 to $-40\text{ }^{\circ}\text{C}$.

2.2.5.7 Whey

Whey is normally evaporated to a supersaturated solution with a total solids content of 60 to 73 % to produce lactose. In cooling down the solution, crystallisation starts and the crystals begin to grow. The crystals are removed from the liquid phase by centrifugation. Depending on the required grade, further purification or refining can take place by washing the crystals, or redissolving them and recrystallising them, followed by treatment with active carbon for the removal of any impurities.

2.2.6 Grain mill products

There are a number of cereals important as food sources. These include wheat, barley, maize, oats, rye and rice. Wheat and rye grain is milled into flour. Durum wheat is milled into semolina and is generally used to make pasta. Wheat is the prime ingredient used in the manufacture of products such as bread and biscuits. In some countries, rye is used for bread. Barley is mainly used for animal feed. Barley of a certain quality is processed to malt and then used, e.g. in brewing and distilling. Maize is used as a source of starch but also as an ingredient in breakfast cereals and snack foods. Oats are used for cereals, cakes, biscuits, and also for making crispbread. Rice, along with wheat and maize is one of the major cereals of the world and is the basic food for much of the world's population. Rice is pearled and sometimes precooked.

The wheat grain has three main components, the skin or bran, the embryo or germ, and the endosperm, which makes up the majority of the grain. The object of the milling process is to separate the endosperm with minimal contamination from the bran and germ. The main operations associated with flour milling are cleaning, conditioning, breaking, scalping, purification, reduction and dressing.

The incoming grain is transferred to bulk silos prior to further processing. Gas or heat treatment may be applied to prevent insect infestation. The grain is first washed by passing through a series of screening, scouring, brushing and aspiration operations. These processes remove extraneous matter such as other cereals, stones, metal contaminants, chaff, loosened bran layers, seeds and dust. After washing, the grain is conditioned to optimise the milling process. This involves dampening the grain by the measured addition of water, which immediately binds the kernels. Conditioning may be made by using steam. Conditioning has a number of functions, such as toughening the bran, and thereby improves the separation of the bran from the endosperm, allowing the endosperm to be reduced more effectively in subsequent stages of the process.

The conditioned grain enters the break system of the mill, which consists of pairs of corrugated rollers which revolve in opposite directions and at different speeds. Five sets of break operations are common, with the aperture gradually decreasing and the corrugation becoming finer between subsequent sets. The grain is split by the break-rollers and the endosperm is scraped from the bran. A screening operation known as scalping or grading is carried out after each break-roller. This operation separates:

- coarse particles which contain the remains of the grain and some endosperm which is yet to be recovered
- particles of intermediate size which contain chunks of endosperm which are called semolina or middlings, depending on their particle size and purity
- flour.

The semolina or middlings pass through a purification system consisting of sieving and air classification. This removes particles of endosperm with bran adhering for further treatment by finely fluted rollers elsewhere in the process. The semolina or middlings are then transferred onto reduction rollers, which are smooth and whose purpose is to crush the endosperm. As in the break section of the mill, there are a series of rollers and screening operations, so that flour is screened off whilst the coarser endosperm, retained on the sieves, passes to another set of reduction rollers to be further reduced in size. At the end of the reduction process, most of the endosperm will have been converted to flour, the coarse bran will have been removed and there will be a third stream of endosperm consisting of material containing fine bran which cannot be practically separated. There could be as many as 12 reduction stages in the process. Flour is normally passed over a final redresser at the end of the milling process or after bulk storage to remove any residual foreign bodies. Flour may be dried and classified by sieves into fractions. Practice varies in different MSs, e.g. in the UK, 25 % is bagged for delivery to bakers and other food manufacturers and 70 % is delivered in bulk, whereas in Portugal, the proportions are almost identically opposite.

Grains such as oats and barley, with a tightly adhering husk cannot simply be separated in a traditional wheat mill and are usually subjected to an abrasion process called pearling prior to milling.

2.2.7 Dry pasta

In modern pasta factories, the manufacturing process is continuous. Semolina is stored in silos. It is then sent by pneumatic conveyers to the production area. Semolina is sieved and then mixed with water to form dough. Semolina has a starting moisture content of 10 to 14 %. In the mixing operation, 22 to 30 kg of water is added per 100 kg semolina. The moisture content during mixing varies between 30 and 35 %, depending on the quality and the type of semolina, and the shape of the pasta being produced. The weight of semolina and the flow of water being fed to the process is continuously monitored and automatically regulated using microcomputers. At this stage in the process, it is important for the semolina to be well hydrated and in a uniform way, to maintain an equal consistency in the dough. This ensures the quality of the final product, e.g. by preventing brittleness, surface defects and poor cooking quality.

The final mixing operation is degassing in a vacuum mixer, which removes the air that has been introduced during the earlier mixing operation. This prevents oxidation of the semolina pigments, or of the egg, in the case of egg pasta and gives a shiny appearance to the product. The pasta is pressed, extruded or laminated, depending on the shape of the final product. This is carried out using a worm screw within a cylinder which is cooled from outside. This physical action also causes the hydrated proteins to interact to form gluten. The dough is extruded at pressures varying between 4 and 12 MPa through a bronze or steel die corresponding to the shape of the product. If the holes of the die are faced with Teflon, a smooth pasta is obtained, otherwise a pasta of rough appearance is produced. The pasta comes out of the die with a moisture content of about 30 %. The final moisture content should not exceed 12.5 %, to achieve the required specific consistency and enable a long shelf-life. This, and the cooking characteristics of the product, are achieved by drying the pasta in three distinct stages, known as pre-drying, central drying and final drying.

Pre-drying comprises intensive ventilation to create a thin dry surface area which prevents the various pasta pieces from crushing or sticking to each other. Filtered air, devoid of dust and other impurities, is used. The temperature and humidity are both controlled to regulate the evaporation rate and prevent fragility, which happens if the pasta is dried too quickly. Formation of mould occurs if the process is too slow. Pre-drying takes 10 to 60 minutes and removes 15 to 20 % of the moisture present. This phase is not needed for long pasta since it is transported hanging from canes, and there is less danger of sticking and deformation.

Central drying is achieved by another hot airflow repeated after alternate phases of rest, known as tempering. Tempering allows the moisture remaining inside the pasta to be redistributed uniformly on the surface. In some pasta production lines, tempering is not needed. During central drying, up to 60 % of the moisture present is removed.

During final drying, the pasta is passed through several chambers, where it is subject to a powerful hot and dry airstream that removes up to 25 – 30 % of the initial moisture. This last phase is carried out at variable temperatures, which may exceed 80 °C. The temperature and the duration of the cycle vary according to the type of technology employed and the type of pasta required. Depending on the kind of production line, drying can be performed in separate chambers or in an uninterrupted tunnel, subdivided into three continuous stages.

The design of production lines vary depending on the shape of the pasta, e.g. lines for long pasta have spreaders to hold the strips straight and to keep them apart, and lasagne, nest and tangle pasta lines have special layouts and lines producing short pasta so have initial kneaders. At the end of the drying line, a cooling chamber lowers the temperature of the dried pasta before it is conveyed to storage silos. The pasta is then transferred for primary packaging, using sheets of plastic or cardboard boxes, before secondary packaging, palletisation and storage prior to dispatch. The dry pasta production process is summarised in Figure 2.17.

For egg pasta, the production process is the same as that for other dry pastas, except for the presence of an automatic measurer for the egg mixture [150, Unione Industriali Pastai Italiani, 2002].

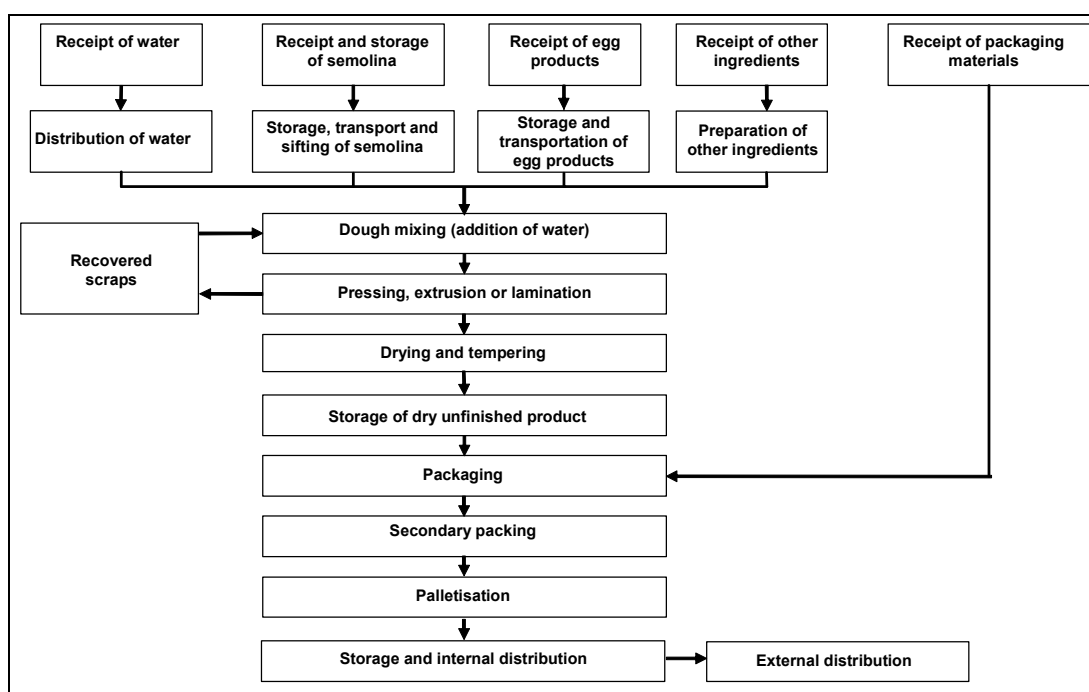

Figure 2.17: Summary of the dry pasta production process
[183, CIAA-UNAFPA, 2003]

2.2.8 Starch

Starch is a high molecular mass carbohydrate produced naturally by plants as an energy reserve. Starch and its derivatives are used in several sectors including food, feed, paper and board, textiles, pharmaceuticals and cosmetics. Purified starch is usually a white powder. Starch and its derivatives can be used for thickening, binding, gelatinising, colouring, anti-crystallising and for sweetening in the food industry. Physically or chemically treated or modified starches are produced to specifically enhance some functional properties. Hydrolysis of starch by acid or enzymes yields a variety of sugar syrups called liquid sweeteners, which can also be dried, and be used in confectionery, drinks, baby food, dairy or baked products. Incomplete hydrolysis yields a mixture of glucose, maltose and non-hydrolysed fractions. Germ is a co-product of the manufacture of starch, and can be used to produce oils. Other co-products are fibre, gluten and de-fatted meal which are all used or sold on for other uses, including animal feed.

The main raw materials used in Europe for the production of starch and its derivatives are cereals, i.e. maize, wheat, barley and rice, and potatoes of dedicated varieties. Each installation is usually technically dedicated to one raw material [10, Environment Agency of England and Wales, 2000, 84, European Starch Association, 2001]. Only starch production from maize, wheat and potatoes is described in this document.

2.2.8.1 Maize starch

The commercial separation of pure starch from maize is achieved by a wet milling process which is generally considered to be efficient. The process is operated as an enclosed system in which process water is re-used in a closed circuit. The addition of fresh water is limited to one point in the production process.

The raw material is washed using aspiration and screening to remove dust, chaff, broken grain, cobs and other extraneous material. The maize is soaked in water with sulphur dioxide (SO₂) or sodium bisulphite (NaHSO₃), for around 36 hours, in a process known as steeping. This removes solubles in the maize, softens the kernel to improve separation of the various components and reduces microbial activity. After steeping, the maize is passed through several grinding and separation operations until only starch and gluten remain. The grain is first ground coarsely and the germs are removed from the coarse grist. After removing the germ, the grist is finely ground and fibre is removed through a screening operation. Starch and gluten are separated, typically using centrifugal methods. This raw starch is washed with drinking water, using a countercurrent flow, in a series of four to six centrifuges. At one end, raw starch is the input and process water is the output and at the other end, refined starch is the output and fresh drinking water is the input. The starch, which at this stage is called refined starch, is then dewatered and dried. Refined starch is typically 99 % pure and 85 – 88 % dry solids. Native starch is refined starch, before physico-chemical modification. The gluten and fibre are collected separately as co-products. An example of a maize starch extraction process is shown in Figure 2.18.

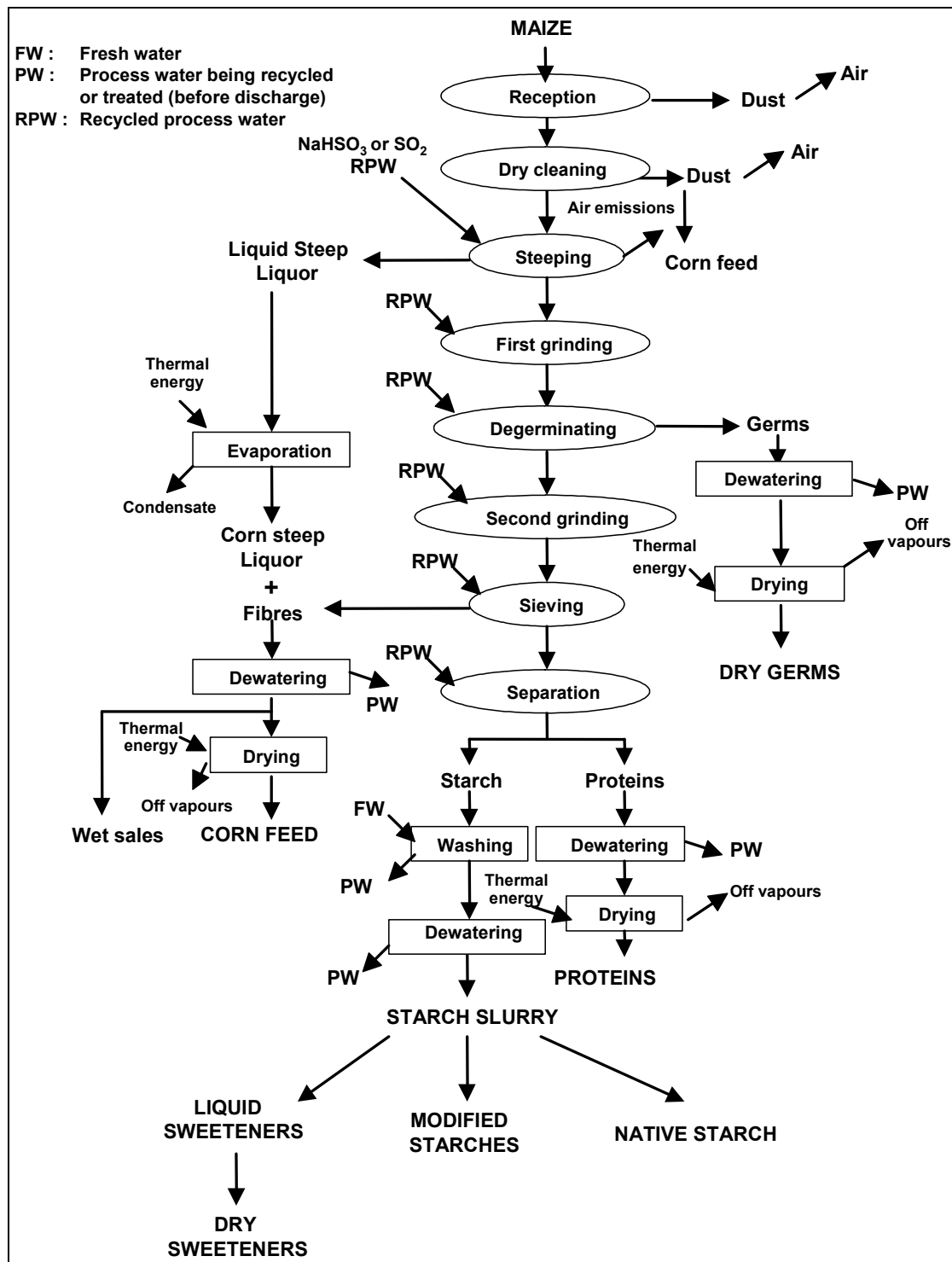

Figure 2.18: An example maize starch production process [84, European Starch Association, 2001]

2.2.8.2 Wheat starch

The commercial separation of pure starch from wheat is achieved by a two-phase process. In the first phase, the wheat kernel is ground or converted into wheat flour by a dry milling process. The second phase then separates the ground wheat or the wheat flour into its separate components, i.e. starch, gluten, solubles and eventually fibre, by a wet separation process. The process is operated as an enclosed system in which process water is recycled in a closed circuit. Fresh water is used at some stages of the process. An example of a wheat starch extraction process is summarised in Figure 2.19. The process of washing raw wheat starch to produce refined starch is the same as that for maize starch (see Section 2.2.8.1).

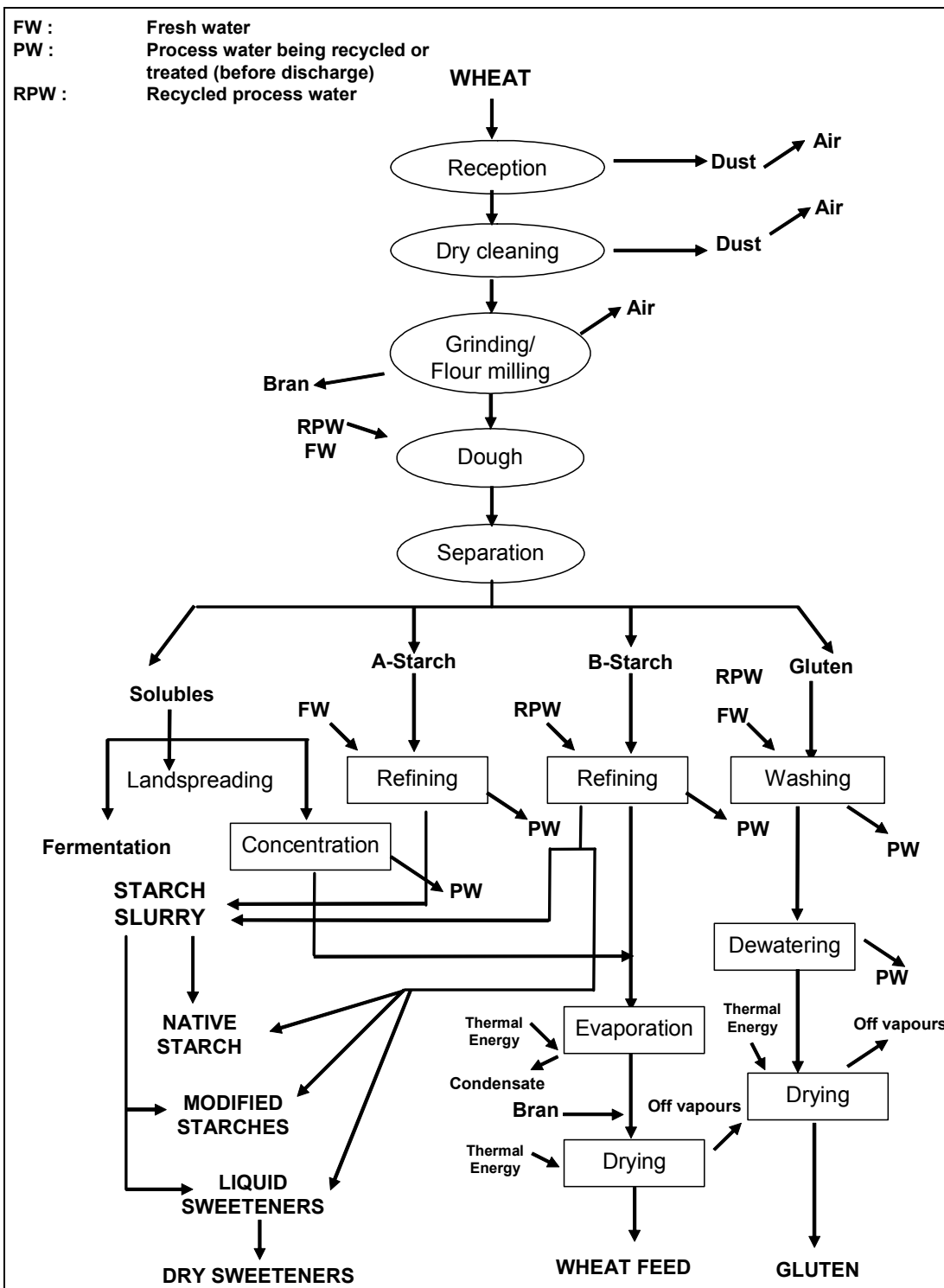

Figure 2.19: An example wheat starch production process [84, European Starch Association, 2001]

2.2.8.3 Potato starch

Starch is extracted from potatoes by a wet process. This involves the disintegration of the tuber into a pulp, which is then dewatered and dried to produce the final product. Fibre and fruit juice are also generated from the tuber. An example of a potato starch extraction process is summarised in Figure 2.20. The process of washing raw potato starch to produce refined starch is the same as that for maize starch (see Section 2.2.8.1).

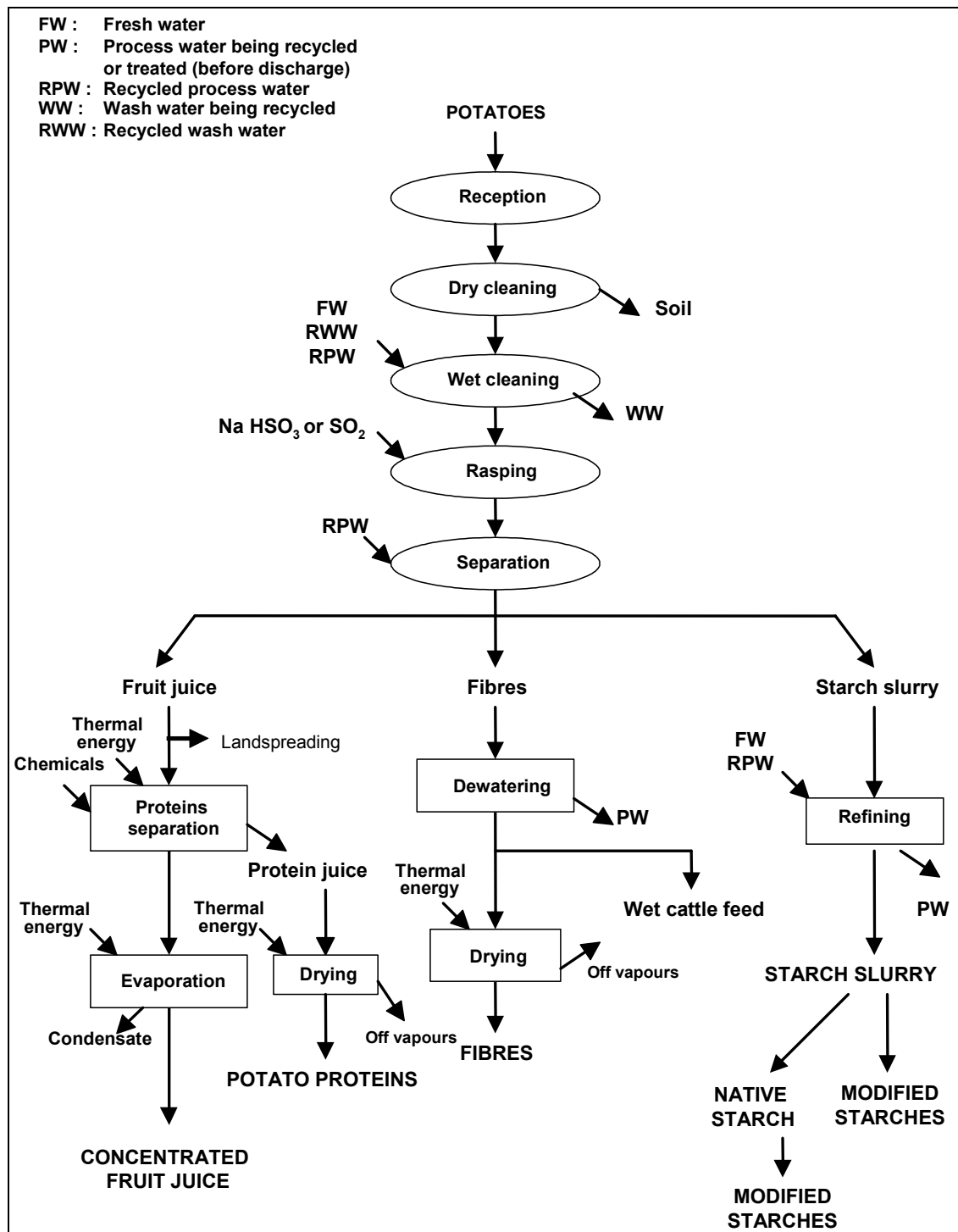

Figure 2.20: An example potato starch production process [84, European Starch Association, 2001]

2.2.8.4 Sweeteners

Starch slurry is the starting raw material for the manufacture of sweeteners or sugar syrups. These are produced by the action of acids, enzymes or a combination of both, however enzymes are more commonly used. In a typical process, the starch slurry is heated to gelatinise the starch and then mixed with acids and/or enzymes and reacted in different liquefaction, saccharification and isomerisation reactors. The temperature is then raised to around 140 °C. Conversion of the starch only takes a few minutes. The mass is neutralised and after several stages of purification, i.e. separation of insolubles, demineralisation and decolourisation, the product obtained is evaporated. The liquor is usually filtered and treated with active charcoal or ion exchange resins to remove colour, ash and other minor impurities, e.g. minerals. The liquid sweetener resulting can be sold as such, or dried, or crystallised to produce dry sweeteners.

2.2.8.5 Modified (physical/chemical) starch

The properties of native starch can be changed to produce modified starch. Modification can be carried out with chemicals, enzymes or physically. The chemicals added can either be dry or wet, so final drying may be necessary. In the dry chemical modification process, dewatered and dried native starch is used. The product is chemically modified starch. In the wet process, the starch slurry, or the re-slurried native starch, is fed directly into the reactor with chemicals and the reaction takes place in liquid form. The resulting slurry can be washed and/or dewatered prior to drying. The product is a physico-chemically treated or modified starch.

2.2.9 Animal feed

The compound feed industry consists of two distinct sectors, i.e. animal feed and petfood. Animal feeds are predominantly dry, while petfoods often have a significant moisture content. In both sectors, the manufacturing process involves the blending of a range of ingredients such as cereals, protein sources, vitamins, minerals, fats and oils, to produce nutritionally balanced foods.

By far the most important moist petfood ranges are those for dogs and cats. These foods are classified according to moisture, packaging and processing systems, and include moist foods and semi-moist foods. In the UK, although moist foods currently comprise a major portion of the market, semi-moist foods are becoming increasingly popular. Moist foods have a moisture content of 60 to 85 % and are usually preserved by heating. Heat treatment may be applied before or after packaging. Moist foods can be subdivided into canned foods, premium moist foods, brawns and frozen meats.

2.2.9.1 Animal feed and dry petfood

The main animal feed types are compound feeds. These consist of a variety of blended ingredients. The composition is varied depending on the type and age of the animal to be fed, but typically includes ingredients such as cereals, animal and vegetable proteins, fibre sources, minerals and supplements such as vitamins, antibiotics and other additives. Some of the ingredients are co-products and by-products of the FDM sector.

The raw materials are received at the feed mill and may be pneumatically conveyed or mechanically transferred to bulk storage silos. Some small ingredients which may be mixed in during the process, such as supplements, may be sent pre-bagged in appropriate quantities. Ingredients are weighed automatically in modern installations and transferred to holding bins prior to grinding, typically using hammer mills. After grinding, the ingredients are thoroughly mixed and any supplements are added. The blend may then be drawn off as meal or mash feed, or pressed to produce pelleted feed. More commonly, the blend goes on to be manufactured into feed pellets. Steam is injected into the feed in a process known as conditioning before being forced through holes in the pelletising die. The resulting pellets vary in size depending on the intended use. After this stage of manufacture, the pellets are dried and then cooled, typically in

coolers in which the pellets enter from the top and cool air is blown in from the bottom. To account for moisture loss during pelletising, drying and cooling, water may be added to some feeds, at the blending stage. The pellets are then either stored in bulk or packed. Some feeds may be coated in fat prior to packing.

2.2.9.2 Moist petfood

The raw materials used in moist petfoods are typically co-products of the FDM sector. These co-products must be fit for human consumption, although they would not typically be used for this purpose. Ingredients used include meat processing co-products, whole grain, ground cereals, flavourings, and vitamin and mineral supplements. Petfoods are designed to be nutritionally balanced to meet the needs of a particular type of animal.

2.2.9.3 Semi-moist petfood

The raw materials used in moist petfoods are typically co-products of the FDM sector. Ingredients commonly used include dry cereal sources, vitamin and mineral supplements and some meat slurries. The ingredients are blended, conditioned and extruded into small shaped pieces. The pieces are dried and fat or meat extracts may be sprayed onto the surface. This type of feed is often multi-component. After drying, various fractions manufactured in a similar way are blended to produce the finished feed. The feed is then packaged.

2.2.10 Bread

One of the main bakery products is bread. Bread includes several bakery products and the types vary significantly from country to country.

In **France**, about 80 % of bread is still produced in small bakeries. The most common traditionally eaten bread is the baguette. It is produced with four basic materials, i.e. flour, water, salt and yeast. It represents more than 50 % of French bread production. Other French speciality breads include fine wheat bread or “pain de gruau”, viennese bread, and biscottes [87, Ullmann, 2001].

In **Germany**, baked products are divided into two types. The production of bread allows a maximum of 10 parts sugar and/or fat to 90 parts flour. Products with more than 10 parts sugar and/or fat to 90 parts flour are called fine bakery wares or “Feine Backwaren”. Bread is divided into five main groups:

- wheat breads, at least 90 % wheat
- mixed wheat and rye breads, at least 50 % wheat
- mixed rye and wheat breads, at least 50 % rye
- rye breads, at least 90 % rye
- bread specialities.

Each of the first four groups were established based on the proportion of wheat and rye in the formula. These groups are further classified into subgroups according to the type of milled raw materials used, i.e. low extraction flour bread, meal bread, and wholemeal bread. Speciality breads can also be prepared. These contain, e.g. nonbread grains, such as oat, barley, rice and maize; raw materials of plant origin, such as oilseeds, germs and raisins, materials of animal origin, e.g. milk, butter, yogurt and whey. Otherwise they may be produced by using special baking techniques, e.g. a wood-heated oven; steam oven or stone oven. From the total German bread consumption, about 15 % is eaten as small rolls and its consumption is increasing. Recently, the so-called nonbread grain breads have become very popular. Also the production of dark breads such as wholemeal flour breads is on the increase [87, Ullmann, 2001].

The typical UK sandwich bread has a high volume, soft texture, very fine porous crumb structure and is also characterised by long shelf-life properties. Speciality breads comprise germ breads with the addition of 10 – 25 % wheat germs and high protein breads with wheat gluten, milk, or sometimes soy protein. Malt bread produced in the UK is a sticky, sweet, dark loaf that might also contain dried fruit pieces. UK rye bread is usually made from a 50:50 mixture of white wheat flour and rye flour [87, Ullmann, 2001].

Bread is made by combining flour, water, salt and yeast. Wheat is the most important cereal grain produced and traded in the world for the production of bread and other baked products. Commercial production of bread may also involve the addition of preservatives and additives to improve flavour, texture and prevent microbiological growth. Production of most baked products containing wheat flour begins by mixing the ingredients to form a dough. Incorporation of air during dough mixing is necessary to achieve a baked loaf of good volume, structure, and texture. As dough becomes cohesive, it starts to incorporate air and, thus, decreases in density.

After bulk fermentation, the dough is divided into individual loaf-sized pieces, and then given time to allow the dough to relax before moulding. The moulding operation is essentially sheeting followed by curling, rolling and application of pressure. As the dough is sheeted, i.e. passed between rolls to be flattened during the various processes, it must be sheeted in different directions. Continued machining in one direction would align the protein fibrils and result in a dough that was strong in one direction but weak in the direction of a 90° angle to the sheeting. After being moulded, the loaf is ready for proofing. This is usually accomplished at 30 to 35 °C and at 85 % relative humidity. Because the dough now has only limited viscous-flow properties, it fills the pan by expansion. Proofing usually takes about 55 to 65 minutes; the dough increases greatly in volume. After proofing, the dough is ready for baking.

Baking times and temperatures and baking temperature profiles vary largely, depending upon the type of bread. For example, a wheat bread is usually baked for 35 to 40 minutes at 220 to 230 °C. In the UK, baking normally takes place at around 220 to 270 °C for 21 to 30 minutes. Heat is transferred by direct or indirect heat to the loaf. The most common energy source is the combustion of natural gas, although electricity may also be used. Combustion gases and volatiles from the oven are released via a stack. After cooling, the bread may be sliced before being wrapped ready for distribution.

Typical methods for making bread are the straight dough, sponge dough, sour dough, and Chorleywood process.

In the straight dough process, the dough is allowed to ferment for 2 to 3 hours. After fermentation, the dough is divided into loaf sized pieces, rounded into a ball, given an intermediate proofing time of 10 to 20 minutes, and then moulded and panned.

In the sponge dough process, a sponge is prepared from approximately 65 % flour, water, and yeast. The sponge is only mixed enough to have a uniform mixture and then allowed to ferment for 3 to 4r hours. After fermentation, the sponge is returned to the mixer and mixed with the rest of the formula ingredients. At this stage, the dough is mixed to optimum development. After mixing, the dough is allowed to relax for 15 to 20 minutes.

Utilisation of the sour dough process is the traditional leavening method in bread making. Bread doughs containing higher proportions of flour or meal require more acidification than is generally achieved by a sour dough process. During sour dough fermentation, a typical microflora develops that includes lactic acid bacteria, *lactobacilli*, and yeasts. Various sour dough processes, such as multi, two and single-stage varying from 2 hours up to 24 hours, were designed to increase the growth of yeast and lactic acid bacteria to give the final sour dough proper acidity, especially the lactic acid/acetic acid ratio, and achieve the desired dough consistency. Often baker's yeast, *Saccharomyces cerevisiae*, is added to accelerate the leavening process. Consequently, proof time of sour dough bread is often long, in the order of several hours. For the production of rye bread, acidification is required.

In the UK, the majority of commercial bakers employ the Chorleywood process. In this process, dough mixing and development take place in a single operation in the presence of an oxidising agent such as potassium iodate, potassium bromate, or ascorbic acid. This process requires a high quality wheat flour with a protein content of 12.5 % dry matter together with a high level of starch damage and hence high water absorption. An oxidising improver, fat or emulsifier, and extra water and yeast are mixed in at this stage. The whole mixing and development process lasts between 2 to 5 minutes. All short time systems require high levels of oxidants. The dough ingredients are mixed together with an intensive energy input and transferred to a hopper which is sometimes sprayed with oil. The dough is divided into loaf sized pieces. A preliminary rounding is given to the dough at this stage. The dough is then allowed to rest, first proof, before being given a final moulding and normally placed into tins. The tins may be sprayed with oil before filling. The dough is allowed to ferment a second time, second proof, and may be cut before baking.

2.2.11 Confectionery

2.2.11.1 Biscuits

The principal ingredients used in the manufacture of biscuits are wheat flour, fat and sugar. Water plays an important role in the biscuit making process but is largely removed during baking. Baked goods are normally decorated and ingredients like dried and wet fruit, cream and custard are utilised.

There are two basic dough types are hard doughs and short doughs. Whatever the dough type, the basic process steps involved in the manufacture of biscuits are dough mixing, formation of the dough pieces, baking, cooling and packaging. The methods used at each stage vary considerably depending on the product type. Raw materials are usually received in bulk and automatically metered into dough mixers. Small ingredients such as salt and sodium bicarbonate may be weighed and added by hand. The ingredients are blended and, in the case of hard doughs, mixed to promote a gluten network in the dough. In the case of short doughs, mixing is such that gluten development is deliberately limited. The formation of dough pieces varies depending on the biscuit type. Crackers and semi-sweet biscuits are cut from continuous sheets of rolled hard dough. Crackers require considerable processing as they are built up in a series of thin layers. Most short doughs are formed by rotary moulding, but soft doughs for biscuits are usually wire cut. The biscuits are baked, usually in tunnel ovens. The times and temperatures used vary depending on the product. Ovens may be direct or indirect fired, gas or electric. The baked biscuits are cooled and packed or transferred for secondary processing, e.g. layering of cream fillings. Crackers may be oil sprayed immediately after baking. Cooling is typically achieved by conveying the biscuits around the installation for a set time period.

2.2.11.2 Cakes

The main ingredients used in the manufacture of cake are wheat flour, fat, eggs, sugar, milk powder, water flavourings and raising agents. Cakes are generally made using either the sugar batter or flour batter method. In the sugar batter method, the fat and sugar are creamed together and eggs are added in stages. Several alternate additions of flour and liquid are carried out throughout the mixing. In the flour batter method, the fat and flour are blended together. The eggs and sugar are whisked together and then blended into the fat and flour in stages. The required quantities of liquids are then added in small amounts as mixing progresses.

In continuous mixing systems such as the Oakes and Mondo cake mixers, the ingredients are given a preliminary mix and then fed in a continuous even stream, into the head of the mixer. "All in" high speed cake mixing is being increasingly used. In this method, all ingredients except fruit are added and a fixed amount of mixing is carried out. The fruit is then added in short bursts.

Batters are typically deposited into oil sprayed trays or continuous sheets for products such as Swiss rolls. After baking, the cakes are removed from the tins and cooled. The empty tins are cleaned, rinsed, dried and cooled.

2.2.11.3 Cocoa

Drinking cocoa typically consists of cocoa powder, vanillin, cinnamon, salt, cassia and other powdered spices. Raw beans are received and subjected to a series of washing operations to remove extraneous matter such as fibre, stones, grit, metal, bean clusters and immature beans. The latter two materials may be used for the manufacture of cocoa butter. The beans are roasted. Roasting conditions vary depending on the equipment and the desired product, but are typically in the range of 100 to 140 °C for 4 to 6 minutes. Whole beans or the separated nibs may be roasted.

Winnowing is the separation of the outer shell of the bean from the edible nibs and typically consists of cracking the roasted bean between rollers, followed by air classification to remove the shell fragments. The nibs are ground to produce a cocoa liquor whose particle size is further reduced by grinding mills, which are water-cooled. The particle size is important for the manufacture of chocolate drink but less important for chocolate since this requires some further refining. The liquor or nibs from roasted or unroasted beans are likely to be subjected to a process known as alkalisation which increases the dispersibility of cocoa powder in milk or water when used in drinks. It is also used to modify the colour of the cocoa. Only permitted acids, alkalis and emulsifiers may be used for this process.

Cocoa powder is produced by the hydraulic pressing of cocoa liquor to express cocoa butter and to reduce the fat content of the press cake to the desired level. The expressed cocoa butter is used in the manufacture of chocolate. The press cake is pulverised to produce a cocoa powder. The final product is then packaged.

2.2.11.4 Chocolate

The basic ingredients for the manufacture of chocolate include cocoa liquor, sugar, other sweeteners, cocoa butter, butter fat, milk powder, milk crumb and emulsifiers. The basic operations involved in chocolate production are the preparation and mixing of ingredients, refining and conching. Conching involves agitating the refined material to induce desirable physical changes in the final product and to improve the flavour. Chocolate production has traditionally been undertaken in a device called a melangeur, which accommodates all of the steps involved. Melangeurs are, however, being increasingly replaced by large specialist machines.

The refining stage in the manufacture of chocolate is intended to reduce the size of the particles of cocoa solids in the mix, thus ensuring that the mixture has a smooth consistency. This is achieved by passing the mixture through vertically mounted rollers which need to be water cooled to prevent distortions arising from frictional heating. A number of systems are available for conching, which is a specialised activity inducing complex changes in the chocolate. Processing milk chocolate in a traditional batch conch takes in excess of a day, whilst modern, continuous systems achieve the same result in around 4 hours. Finished chocolate is typically stored in bulk and must be tempered through a cooling and warming cycle before final use.

Chocolate products may be produced by casting the chocolate into moulds, followed by cooling and demoulding. Such methods may be used to produce solid chocolate blocks or shells, which may be hollow or filled with a confectionery such as fondant. Alternatively, liquid chocolate may be used to coat confectionery using units known as enrobers.

2.2.11.5 Boiled sweets

Boiled sweets are highly concentrated solutions of sugar, glucose syrup and sometimes invert sugar, with added flavourings. These are metered into continuous dissolvers. This mixture feeds cookers, of which there are a number of designs such as thin film, coil cookers or batch vacuum cookers. Water is rapidly evaporated from the syrup, which is then discharged and partially cooled due to evaporative cooling. The boiled sweet mass is transferred to water-cooled tables and acid, flavour and colours, are added to the partially cooled mass in a batch or continuous process. The mix is then transferred to forming machinery. The formed sweets are cooled and wrapped in moisture proof packs as rapidly as possible.

2.2.12 Sugar

Sugar (sucrose) is produced from two principal sources, sugar beet and sugar cane. Sugar beet tends to be grown in Europe and sugar cane in hotter climates [134, AWARENET, 2002] such as the West Indies, so it is not extracted in Europe. Sucrose is also available in a liquid form as an aqueous solution, in some cases all or partially inverted. Sugar crystals may be ground to make powdered or confectioner's sugars. Anti-caking agents such as maize starch are added to keep these sugars free flowing.

2.2.12.1 Sugar beet extraction

In general, the extraction of sugar from sugar beet and sugar cane is similar. The beets are cut into thin slices called cossettes. They are passed into a water-based countercurrent extraction apparatus called a diffuser and emerge as impure sugar juice and beet pulp. The fresh water used in the extraction process is actually condensed water from the subsequent evaporation steps together with recirculated water from the pulp pressing. The temperature inside the diffuser is 68 to 72 °C.

Three types of diffusers are used. Horizontal diffusers are large revolving drums, separated into cells by a helix attached to the interior surface. As the drum and helix revolve, the juice, which stays at the bottom of the vessel, is transported countercurrently to the cossettes, i.e. the exhausted beet pulp leaves the diffuser at the same end where the fresh water enters. Vertical diffusers are composed of an extractor with two main and distinct parts, i.e. the countercurrent mixer and the extraction tower. The tower is a 14 to 20 metres high cylinder. Inside the tower, a tubular shaft rotates slowly. Special helicoidal steel pieces, or flights, are fitted on the shaft and move the cossettes upwards. The juice and the cossettes move countercurrently. Slope diffusers consist essentially of a U-shaped sloping vessel in which two overlapping screws with opposite pitches rotate. Fresh cossettes fall from a conveyor belt into the lower end. The cossettes are transported upwards by the two screws to a paddle wheel, which lifts the exhausted cossettes out of the extractor. Fresh water is introduced at the upper end and the sugar juice leaves the extractor through a screen at the lower end.

The crystallisation process takes place in vacuum pans in which the juice is boiled under vacuum to minimise the temperatures involved. The growth of the sucrose crystal only involves sucrose and water. The non-sugars contained in the sugar juice are not incorporated into the crystal structure, instead most of them remain in the liquid phase while some are released to the vapour phase. The sugar crystals are removed from the liquid phase by centrifugation.

Sugar to be stored in silos must be dedusted and cooled to the storage temperature. This is carried out in a sugar cooler, which is a device in which warm and dried sugar is intensively aerated by cold filtered external air to cool the sugar to the storage temperature, approximately 20 to 30 °C. The most common systems in use are typically drum or fluidised bed coolers with chilling systems that have a countercurrent or cross-current phase flow.

2.2.12.2 Sugar cane

Raw cane sugar is usually separated, purified and crystallised in the country of origin. The cane sugar, which is in a crudely refined state, undergoes final processing when transferred to the country of use.

2.2.12.3 Sugar refining

Raw sugar is typically a minimum of 96 % sucrose. The impure crystals, with adhering molasses, are blended in a saturated sugar solution to soften the surface molasses film which can then be removed by centrifugation. The partly processed sugar is dissolved in reclaimed liquors, i.e. light waters from the refining process. Carbonation, which is treatment with milk of lime and carbon dioxide, then follows. This produces a precipitate which contains impurities such as pectins and proteins and removes suspended impurities such as waxes, gums and starches. The sugar syrup is filtered and decolourised using ion exchange resins and activated carbon to produce a fine liquor, which may be sold as a finished product or passed on for crystallisation.

The fine liquor is concentrated by evaporation to produce a syrup of around 60 – 70 % solids, known as thick juice. The juice is filtered and transferred to vacuum pans. When the liquor is slightly supersaturated, the pan is seeded with fine icing sugar to initiate crystallisation. The mixture is centrifugally separated to extract crystalline sugar, which is dried, conditioned for packaging or bulk loaded. Each pan boiling yields around 50 % of the available sugar.

The liquor separated during centrifugation, also called jet, is re-boiled for further extraction. Three boilings yield white sugar. A fourth boiling yields off white industrial sugar. Jet four, together with liquor from blending, goes to a recovery house for three further boilings to produce brown sugars which go back to the start of the refining process and are treated as raw sugar. Various intermediary products from jets one to four and the corresponding syrups from recovery and boiling are sold as the starting materials for syrups such as molasses and treacle. Molasses are sometimes used in animal feed, alcoholic fermentation and a number of non-food products.

2.2.13 Coffee

Commercial coffees are grown in tropical and subtropical climates at altitudes of up to around 1800 metres. Coffees from different producing regions possess different characteristic flavours. The main processing steps in the manufacture of roasted coffee are blending, roasting, grinding and packing. Instant coffee is produced from a water extract of roasted ground coffee. Roasting coffee beans and the production of instant coffee are energy intensive processes.

2.2.13.1 Roasting coffee

Green coffee is received and sorted to remove extraneous matter. Coffees from different varieties or sources are blended before or after roasting. Roasting is usually carried out by hot combustion gases in rotating cylinders. The final bean temperature is around 200 to 220 °C. A water or air quench terminates the roast. Most of any added water is evaporated from the heat of the beans. Fluidised bed systems may greatly reduce roasting times from around 8 to 15 minutes to 1 to 3 minutes. Finished coffee is transferred to storage bins. Any residual foreign bodies are removed before grinding, usually by air classification methods. Most coffees are ground in steel cutting rollers which are scored, once longitudinally and once across the circumference. Cracking rolls break the beans before they are fed into a further series of rollers. For fine grinds, the coffee may pass into further sets of rollers, being scored on each subsequent pair of rollers and becoming progressively finer as the coffee travels through the system. Roasted and ground coffee in Europe is typically vacuum packed in flexible pouches of plastic-laminated foil.

2.2.13.2 Instant coffee

Instant coffee is subjected to similar processing, namely blending, roasting and grinding, although processing details such as particle size after grinding may differ. During extraction of coffee for the production of soluble coffee, water is the extracting solvent. The coarsely ground coffee is extracted in a battery of batch percolating columns. The process is operated semi-continuously with water in a countercurrent flow to the coffee, from the most extracted cell to the one just filled with fresh roast and ground coffee.

The extract is recovered from the fresh or least-extracted cell. One consequence of using high temperatures is that the system must be kept under pressure, so, the individual cells and associated pipework has to be designed accordingly. Once a batch of solids has been extracted, the exhausted cell is separated from the train and the spent grounds are discharged. At the same time, a cell containing fresh roast and ground coffee is added to the train. The extraction yield is expressed as the amount of recovered water-soluble dry solid content of roasted coffee as a percentage of roasted coffee (dry weight). Yields of 40 to 56 % are obtainable. Some manufacturers vacuum-concentrate the extract. The extract is dried, typically by spray-drying or freeze drying. The powder may be agglomerated to improve solubility. The final product is then packed into containers.

During the extraction of soluble solid matter from the roasted coffee, a large quantity of coffee grounds is produced in addition to the fluid coffee extract. These are utilised as fuel in special grate firing installations. The ground coffee is used, in balance with heating oil and natural gas, as a special fuel.

The following paragraphs describe the manufacture of instant coffee in an example installation which produces 18000 tonnes of green coffee per year. A diagram of the process is shown in Figure 2.21.

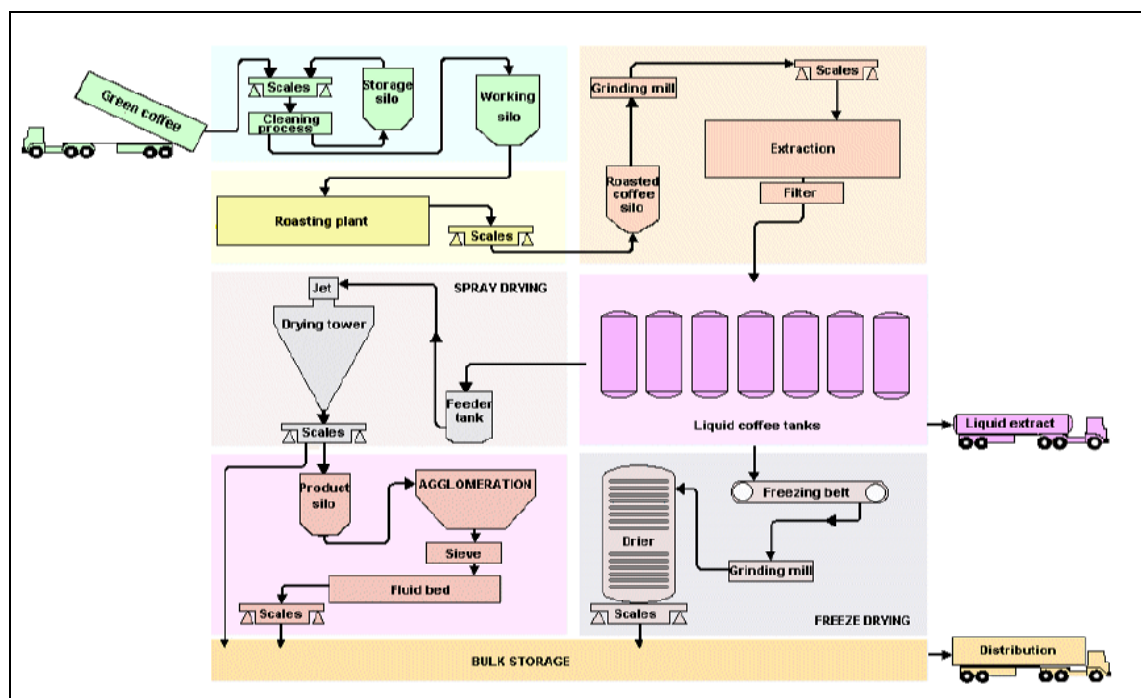

Figure 2.21: Instant coffee manufacturing

The arriving green coffee is picked up by discharge hoppers and mechanically cleaned through sifting and air separation before it reaches the silos. The raw coffee is roasted to enable its characteristic aromas and flavours to be appreciated. Then, after the coffee beans are ground, hot water is added to produce an extract. The extract is clarified and concentrated. A portion leaves the company in its now liquid form. This portion is transported by a road tanker to other installations for further processing.

The separation of the extract from water can be carried out by means of spray drying or freeze drying. Spray drying is carried out in a 30 metres high tower. The liquid coffee extract produced during the extraction is injected at the top, the drops fall downwards and reach a hot zone in which the water is extracted. On the floor, the dry, now powdered form of the product, is drawn off. The heat utilised can be partially recovered through countercurrent heat-exchangers. Also, the water used in the extraction process can be collected after drying to be re-used during production.

After drying, a portion of the end-product is transported for pelletising/agglomeration. With the aid of agglomeration processes, the fine grained powder particles that are created during drying combine into coarser particles. The particles are moistened through the addition of steam and water and conglomerated on rotating surfaces or belts. During this process, the residual moisture of the products is raised again, so subsequent drying in vibration driers is necessary.

During freeze drying, the extract is first frozen and reduced in size. In the subsequent drying step, the moisture is extracted under a high vacuum. For the freezing of the extract, extremely low temperatures, e.g. $<-50\text{ }^{\circ}\text{C}$, are required. In the example installation, the cold temperature is produced by ammonia adsorption refrigeration plants, so the use of chlorofluorocarbons can be avoided. The removal of the ice is carried out under vacuum. The vapour is evacuated from the drying chamber by means of special high performance vacuum pumps. The exhaust air resulting from this, as well as containing volatile coffee ingredients, also contains quantities of oil from the pump system. The oil mists are intercepted in oil filters, and the separated oil content is recirculated. This process results in a granular final product.

Finally, the dried instant products are filled into bulk packaging, e.g. aluminium containers and big bags, of approximately 350 – 400 kg and prepared for shipping.

2.2.13.3 Decaffeinated coffee

Green beans are moisturised by steam or water to a moisture content of around 20 %. Solvents are then used to extract the caffeine from the wet beans. Decaffeination of coffee is carried out by extraction with decaffeinating agents, such as water or another solvent such as methylene chloride, coffee oils, ethyl acetate or supercritical CO_2 . Extraction yields of 97 % of the caffeine can be obtained. Steaming or stripping is used to remove solvent from the beans. Two main extraction methods for decaffeination can be distinguished, i.e. the direct and indirect methods. The beans are then re-dried to their original moisture content prior to roasting. Solvent extraction of the caffeine, from the extract used to make instant coffee rather than from the bean itself, may also be applied.

The direct method is called solvent decaffeination. In this method, solvents, such as methylene chloride, coffee oils, ethyl acetate or supercritical CO_2 , are used. The main process parameters are temperature and time. These vary depending on the type of coffee and on the type of solvent. For example, when coffee oil is used as the decaffeinating agent the process may take 6 to 9 hours at $95\text{ to }105\text{ }^{\circ}\text{C}$, whereas supercritical CO_2 is used under high pressure at $40\text{ to }80\text{ }^{\circ}\text{C}$ for 5 to 30 hours. Table 2.8 summarises the process.

	Action	Effect
1	Green beans are first soaked with water and steam	Beans swell by 30 – 40 %
2	A decaffeinating agent is added to the wet beans	The agent solubilises the caffeine from the beans
3	The agent is drained or steamed away	The agent, together with 97 % of caffeine, are removed from the beans
4	The beans are dried by hot air or vacuum drying	The beans are dried and are now ready for roasting

Table 2.8: Solvent decaffeination process

The indirect method is called water decaffeination. In this method, water is used as the extraction solvent. The process is described in Table 2.9.

	Action	Effect
1	Green beans are first soaked with water and steam	The water extracts the caffeine, but also some soluble coffee solids
2	The beans are separated from the aqueous solution	The water extract containing caffeine and coffee solids is separated
3	Water extract is passed over an activated charcoal bed. A solvent, e.g. methylene chloride, may be used instead of activated carbon	The caffeine is removed from the solution by activated carbon filtration or methylene chloride. The coffee solids remain in the aqueous solution
4	The decaffeinated extract is concentrated and added back to the pre-dried decaffeinated beans	Beans and coffee solids, now without the caffeine, are ready for roasting

Table 2.9: Water decaffeination process

2.2.14 Yeast

Yeasts are single cell fungi used in a wide range of fermentation processes such as baking, beer brewing and the manufacture of wines and spirits. Yeast is usually supplied to food manufacturers either in a crumbled/compressed form or as active dry yeast. Although methods vary, the essential steps in conventional processing are as described below.

Propagation takes approximately 6 to 8 days on a commercial scale using propagators sized between 91000 and 227000 litres. Yeast production initially involves a series of small propagations. The yeast produced at each stage being used to seed the subsequent propagation. Ingredients typically added to the fermenter are cane and beet molasses, blended and clarified before addition; ammonia; phosphoric acid; vitamins; minerals and de-foaming agents. Aeration of the fermenter is essential to achieve optimum growth. Air is introduced by bubbling through a series of parallel pipes fitted at the bottom of the vessel. In agitated vessels, air is usually introduced through a doughnut shaped sparger, located just underneath the stirred blades. In general, 100 grams of dry yeast matter require 102.5 grams of oxygen to be supplied during fermentation. Temperature and acidity must be regulated to optimise yields. Typically, fermentation is carried out at 30 °C and at a pH of 4.5 – 6.5. Water may be used in external heat-exchangers or internal coils to maintain the fermentation temperature, which otherwise tends to rise due to the yeast growth.

After propagation, the fermenter contents are cooled and the yeast crop is removed by centrifugal separators. The yeast cream is washed to improve its colour and cooled. Crumbled yeast is produced by pressing in a plate and frame filter or a vacuum filter. Alternatively the crumbled yeast may be mixed with emulsifiers and extruded to produce yeast blocks. Dried yeast is produced in a similar manner but is extruded through a perforated plate to produce strands of around 3 mm diameter and 0.3 to 1 cm long. The strips are usually dried in rotary or tunnel driers before grinding and packaging. Dried yeast is usually packed in hermetically sealed containers or film with a headspace of nitrogen to extend its active shelf-life.

2.2.15 Malting

Malt is a product derived from germinated grain, e.g. barley, oats or wheat, which is dried in kilns. Malts are fermented to make beers and lagers or may be fermented and then distilled to make spirits such as whisky. Malts may also be used in a range of foods such as non-alcoholic malted drinks, breakfast cereals, baby foods and animal feeds.

Malting activates and develops a number of enzymes including amylolytic and proteolytic enzymes. Amylolytic enzymes break down starch to fermentable carbohydrates. Proteolytic enzymes act as flavour precursors and as nutrients for yeast in subsequent fermentations. Malting involves controlled wetting by steeping, germination and drying of the grain. The process must be carefully controlled to induce the desired physico-chemical changes required, whilst at the same time minimising weight loss due to germination and respiration. The malted grain is dried to halt growth, stop enzymic activity and produce a stable product with the desired colour and flavour. Drying is followed by cooling down to 25 to 35 °C and by the removal of malt sprouts.

Two types of malt are generally produced on a commercial scale, i.e. brewers' and distillers' malts. Both types use barley as the starting raw material. Other cereals, such as wheat or rye, can also be used. Brewers' malt is made from plumper, heavier barley kernels with a friable starch mass. The barley is cleaned and then steeped in water at around 16 °C ranging from 10 to 25 °C for about 1 to 3 days. The actual temperature and steeping periods depend on the equipment, the process parameters, the raw material and the finished malt to be obtained. Steeping may occur in alternate stages of wet and dry periods. The barley is germinated at moisture contents of about 45 %, ranging from 30 to 50 %, depending on the same issues.

The resulting green malt is air-dried in kilns. Hot air, is blown through a layer of green malt of about 50 to 150 cm thickness, without any fluidisation of the batch. The blowing lasts around 16 to 24 hours in one floor kilns and 32 to 48 hours in two floor kilns. For pale coloured malts, resulting in a moisture content of 3 to 6.5 %, the starting air temperature is around 50 °C and it is increased to around 70 to 85 °C. To obtain darker coloured malts, with lower humidity levels, the temperature is increased further to 130 °C. Kilning is carried out in several stages to ensure that moisture is removed effectively without unduly reducing the enzymatic activity. In general, the airflowrate reduces and the air temperature increases as the kilning progresses. At the end of the kilning process, the dried malt is cooled down to about 25 to 35 °C and the malt culms are removed.

Distillers' malt, also called high diastatic malt, is made from small kernelled barley which is high in protein and enzymic potential. The barley is steeped at higher moistures levels ranging from 45 to 49 % and dried at lower temperatures, ranging from 49 to 60 °C to a higher final moisture content ranging from 5 to 7 %. Brewers' malt tends to be darker than distillers' malt and has an increased flavour and aroma.

Germination of the steeped grain can be brought about with a range of equipment, but essentially the process consists of subjecting the grain to a stream of humidified air at around 10 – 30 °C, depending on the equipment, the process parameters, the raw material and the finished malt to be obtained. The grain temperature varies between 15 and 45 °C due to the heat developed from respiration. Periodically, the grain is slowly turned and, in some cases, humidified to ensure an even temperature distribution and to prevent matting of rootlets. Germination has traditionally been carried out on concrete floors in cool moist rooms with the grain turned manually, but this method is now being replaced by more modern mechanised techniques.

After kilning, malt sprouts are removed in a cleaning stage to yield the final malted grain. This grain may be milled to produce malt flour. Malt extract is produced by hot water extraction from the finished malt, as carried out in the first stage of the brewing process, and then by concentrating the resultant extract, by means of the evaporation of water in evaporation vessels. The raw grain, the green malt or the finished malt can further be processed in the roasting drum to produce roasted barley, caramel malt or roasted malt of different colours and flavours.

2.2.16 Brewing

Beer is traditionally considered to include products such as lager, e.g. Pilsner malt and Munich malt, ale, porter and stout. It is an alcoholic drink derived from malted barley, with or without other unmalted cereal grains, and flavoured with hops. Sugar may also be added. There are three basic steps in the process; mashing, fermentation, and maturation/conditioning.

2.2.16.1 Mashing

Grains are normally received in bulk at breweries and transferred to silos. The malted barley is milled before use, the aim is to crush the endosperm with minimal damage to the husk. After milling, the ground materials or grist are mashed to produce a fermentable substrate for yeast fermentation. Additives may be used as a supplementary carbohydrate source, either to the mash kettle, e.g. maize grist or rice, or to the wort kettle, e.g. sucrose or glucose/maltose syrup. The grist is mixed with hot water to produce a thick slurry. The mix is then held for a sufficient period to allow the enzymes present in the malted barley to break down starch and proteins in the cereals.

Depending on the way in which the temperature is raised, mashing processes are classified into two types, i.e. infusion or decoction mashing. With infusion mashing, the entire mash is heated up, with appropriate rests until reaching the final mashing-off temperature. In decoction mashing, the temperature is increased by removing and boiling part of the mash. By returning it back to the remainder, the temperature of the total mash is increased to the next higher rest temperature. The vessel used for mashing is known as a mash tun. The wort is separated from the brewers grain by filtration in a mash filter or by straining. This is called lautering and takes place in lauter tuns. Once the so-called first wort has run off, the water is sprayed over the spent grist to extract as much wort as possible. After completion of the lautering, the leached brewers grains are discharged to silos and traditionally sold to farmers for use as cattle feed.

2.2.16.2 Fermentation

The wort is boiled for for 1 to 1.5 hours in the wort kettle with hops or hop extracts, releasing bitter substances that are dissolved. The wort is boiled with a boiling intensity of 5 to 8 % evaporation of casting volume per hour. A coarse coagulum of proteinaceous precipitated material is separated from the wort. This is known as the hot trub. Synthetic additives, based on polyester, result in a compact separation of the unpleasant, coarse, and bitter-tasting hot trub.

The wort is clarified in a whirlpool to remove the hops and then cooled to the pitching temperature. The hot cooling water, of about 75 to 85 °C, is collected and used as brewing water and for cleaning. It is possible to produce stronger wort than that corresponding to the original gravity of the final beer produced and it is possible later, before or after fermentation, to dilute it with water to the desired extract content. This is called high gravity brewing. Whether dilution is performed before or after fermentation depends, among other things, on local legislation. A further aim of wort boiling is the inactivation of all enzymes, sterilisation as well as concentration of the wort.

The clear hopped wort is aerated to encourage yeast propagation prior to fermentation and yeasts are added. The particular yeasts strains used are typical for beer production. Yeasts are divided into two major groups, i.e. top and bottom fermenting yeasts. Yeasts that tend to rise to the top of the fermentation vessel are typically used for ales and have a fermentation temperature of about 15 to 25 °C. Yeasts which tend to settle to the bottom of the vessel toward the end of fermentation are typically used in lagers, where the fermentation is normally performed at 8 to 15 °C. To maintain the desired fermentation temperature, the tanks are cooled. At the end of fermentation, the yeast is separated from the product. A part of it is used for another batch, and the remainder is disposed of or considered to be a co-product.

2.2.16.3 Maturation/conditioning

Lagers require conditioning by chilled storage for several weeks before clarification. The beer is generally clarified in a diatomaceous earth filter, e.g. kieselguhr. After carbonation, the beer may be subjected to a number of preservation processes, such as flash pasteurisation and aseptic filling, membrane separation or in-container pasteurisation.

Before bottling, the beer is filtered through a filter cake. Proven materials for this purpose are mud-free kieselguhr; calcined and screened diatomaceous earth of various particle size distribution; and perlite from ground and calcined glassy rock of volcanic origin. Activated carbon may be used to correct a mild off-taste. For example, it is usually used in the treatment of rest beers. Shortly before filtration, hydro- and xero-silica gels may be added to contribute to the build-up of the filter cake. Fining, by the addition of, e.g. cross-linked polyvinylpyrrolidone (PVP) and polyvinylpolypyrrolidone (PVPP) is carried out to clarify the beer and, e.g. reduce the polyphenol concentration.

Cleaning agents and disinfectants are also used.

2.2.17 Distilling

The use of distillation in the FDM sector can be illustrated by the following two examples; the distillations of Scotch whisky and cognac.

2.2.17.1 Scotch whisky

Distillation units in the production of scotch whisky range from simple pot stills to continuous multicolumn stills. Energy is introduced in the form of steam to the bottom of the still and selectively volatilises the alcohol and other components from the fermented liquids and pre-distilled alcohol/water mixtures. The volatile components are recirculated within the still to achieve the correct separation, selection and concentration of alcoholic/aqueous compounds for the many varied and desirable congener profiles required by the various types and brands of products. Stills can be operated singly or in series. The volatile components are condensed by heat-exchange with water in condensers and removed as a liquid spirit. The residual material known as pot ale, spent lees, stillage or spent wash, is discharged from the bottom of the still. In column stills other fractions are also removed such as fusel oils and high feints. The high feints are fed back into the stills and the fusel oils, which are mainly amyl alcohol, are sold as a co-product.

2.2.17.2 Cognac

Cognac is obtained by the distillation of white wines harvested in the controlled appellation area. The distillation of Cognac is a two-stage process. In the first stage, a first distillate, known as “brouillis” is obtained. This has an alcoholic strength of between 28 to 32 % volume. In the second stage, the brouillis is returned to the boiler for a second heating, known as “la bonne chauffe”. The distillation heads, secondes and tails are separated, leaving only the heart of the spirit. There is a restriction on the maximum strength of distillation, which must not exceed 72 vol-% alcohol. The time of each stage is about 12 hours.

Distillation is carried out in two separate heatings or chauffes in a special Charentais copper pot still comprising a characteristically shaped boiler, heated with a naked flame and topped with a cowl shaped like a turban, an olive or an onion. A Charentais still often has an energy saving wine reheater. This device, in which the heat is provided by the alcohol vapours passing through it, preheats the wine, which is to be distilled in the next cycle. The final day for distillation is 31 March of the year following harvesting.

Maturation must be carried out in Limousin or Tronçais oak casks. As with other brandies and matured wine spirits, maturation was aided by the use of oak extracts, but this practice is becoming less common in Cognac. French regulations prohibit the use of additives in the final product, other than water and sugar or caramel, and restrict the minimum strength to 40 vol-% alcohol.

2.2.18 Wine

This section includes red and white wine manufacturing [134, AWARENET, 2002].

2.2.18.1 Reception

When grapes are received at the winery, they are sorted by variety, quality and quantity. Containers are emptied directly into either crushing or transport equipment. Emptied containers are cleaned. The cleaning water is drained.

2.2.18.2 Grape crushing and destemming

Grape crushing or mashing takes place in grape mills. If maceration is intended, the mash can be stored in mash containers. To prevent the mash from oxidation H_2SO_3 is added. The decision as to whether destemming of the white grapes is necessary before the grape mash is made depends on the variety and ripeness of the grapes as well as on the further processing of the mash.

2.2.18.3 Pressing

For white wine, the mash is transported to the wine press. The resulting unfermented grape juice is referred to as must. Sulphur dioxide is often added at this stage at the rate of 100 – 150 mg/l to suppress undesirable micro-organisms, e.g. grape skins are often covered with bacteria and moulds, as well as the yeasts used in the process. The solid residues, e.g. pomace and marc, are then separated.

For red wine, when the fermentation process is finished, i.e. when the sugar levels are under 0.1 %, the wine is taken from the bottom of the tank and the marcs are transferred to the wine press to extract the remaining wine.

2.2.18.4 Fining

The fining agents used in winemaking are gelatine, casein, isinglass, chitin, albumin or egg white; natural mineral adsorbents, e.g. bentonite, diatomaceous earth or silica; and synthetic polymers, e.g. PVPP. It is reported that sediments from clarification are separated by centrifugation or filtration. This removes unwanted particles left in suspension.

2.2.18.5 Fermentation

Alcoholic fermentation takes place in large stainless steel fermentation reactors or vats with or without the addition of pre-cultivated yeast, e.g. usually *Saccharomyces cerevisiae*, and under rigorous temperature control. White wine is fermented after marc separation, while red wine is fermented together with grape marcs. Red wine, and sometimes white wine as well, goes through a second malolactic fermentation. This is a bacterial fermentation that converts the malic acid into lactic acid.

2.2.18.6 Ageing

After fermentation, wine is cooled to 4 – 5 °C and transferred to barrels or wooden vats made of oak for ageing. This allows the wine to stabilise and to develop softer tannins and complex flavours. Lees are separated from the wine every 3 to 4 months. The barrels are then washed and refilled.

2.2.18.7 Cold stabilisation

Cold stabilisation involves rapid cooling of the wine to near freezing temperatures to precipitate tartrate crystals which are undesirable in the bottled wine, whether present in the cork or in the bottom of the bottle. Tartrate precipitates in the tanks and is removed with an alkaline cleaning solution of 10 % caustic soda.

2.2.18.8 Bottling

Before bottling, wine is passed through a filtration system to remove remaining solid and insoluble turbid compounds. Bottling involves the microbial stabilisation of the wine and preserves the wine from important changes in taste and chemical composition.

2.2.19 Soft drinks

Soft drinks can be categorised into two main types, i.e. carbonated and still. Soft drinks include spring waters, fruit and juice based drinks such as cordials, squashes and barley waters; flavoured drinks such as ginger beer; tonic waters and lemonades, as well as infusions such as tea and coffee.

Ingredients typically found in most soft drinks include water, sweetener, acid and flavourings. Optional ingredients include fruit, carbon dioxide, preservatives and colour. Water is the main ingredient of all soft drinks and, as such, the quality of the water, in terms of its microbiological loading and other parameters which affect the final sensory qualities of the drink, are of paramount importance. Most soft drinks are sweetened with natural sweeteners such as sugar and sugar syrups, and/or intense sweeteners such as saccharin and aspartame. Flavourings used in manufacture are often derived from highly concentrated liquid mixtures of plant extracts such as fruit, flowers, seeds, leaves, bark and root. Alternatively, they may be synthetic.

All sparkling soft drinks require the addition of carbon dioxide. This may be sourced as a co-product from the petroleum, beer and whisky industries, or produced on site. The preservation of soft drinks can be achieved by a number of techniques including heating, chemical preservation and filtration. These methods, in combination with low pH, prevent microbiological spoilage.

The basic processes for the manufacture of soft drinks involve the mixing of ingredients in the syrup room, followed by the addition of water that has been subjected to various water treatments. The mixture may be heat processed or chemically preserved at this stage. The product is carbonated if required. Alternatively, after the syrup and water are combined, the product may be filled into packaging and in-pack heat processed. Syrups may require filtration or homogenisation and may be pasteurised. Most packaging is cleaned prior to filling, either by rinsing with water, possibly containing rinsing aids, or by air blasting.

2.2.20 Citric acid

Citric acid, a tricarboxylic acid, exists widely in nature and is produced in almost all living cells as an intermediate substance in the metabolic cycle. Most plant and animal tissues, as well as human serum, contain citric acid in a significant quantity.

The most economical method to produce citric acid is fermentation, which employs a strain of *Aspergillus niger* as an inoculum, to convert sugar to citric acid. The fermentation feedstock or substrate is a carbohydrate, usually molasses, crystalline sugar, glucose from wheat, maize or potato starch, or isomerose. There are two types of fermentation processes, i.e. submerged and surface fermentation. Submerged fermentation is preferred to surface fermentation.

Submerged fermentation consists of three main phases, i.e. fermentation, recovery, and purification of citric acid. The flowchart for this process is presented in Figure 2.22.

In citric acid fermentation, the substrate is prepared in a tank and then sterilised. The inoculum is produced under controlled aseptic conditions. The inoculum and the substrate are transferred aseptically to the production fermenter. The fermentation process requires 3 to 14 days. Finally, the biological solids called mycelium are removed by filtration.

In the recovery of citric acid, the dissolved citric acid is separated from residual sugars, proteins and other soluble impurities by the addition of lime precipitating calcium citrate. Then, the slurry containing calcium citrate is filtered. The filtrate is washed to remove soluble impurities. The waste water generated is discharged. Sulphuric acid is added and this converts the calcium citrate to calcium sulphate and citric acid. Finally, the precipitated calcium sulphate or gypsum is filtered from the slurry and the remaining citric acid solution is further treated.

Ultimately, the citric acid solution is purified by ion exchange and carbon adsorption. The citric acid solution is evaporated and crystallised from the solution (first crystallisation). The citric acid crystals are centrifuged. Later, citric acid is dissolved in water and crystallised again from the solution (second crystallisation). The crystals are centrifuged yet again and are dried, milled and sieved. The resultant citric acid is then packaged.

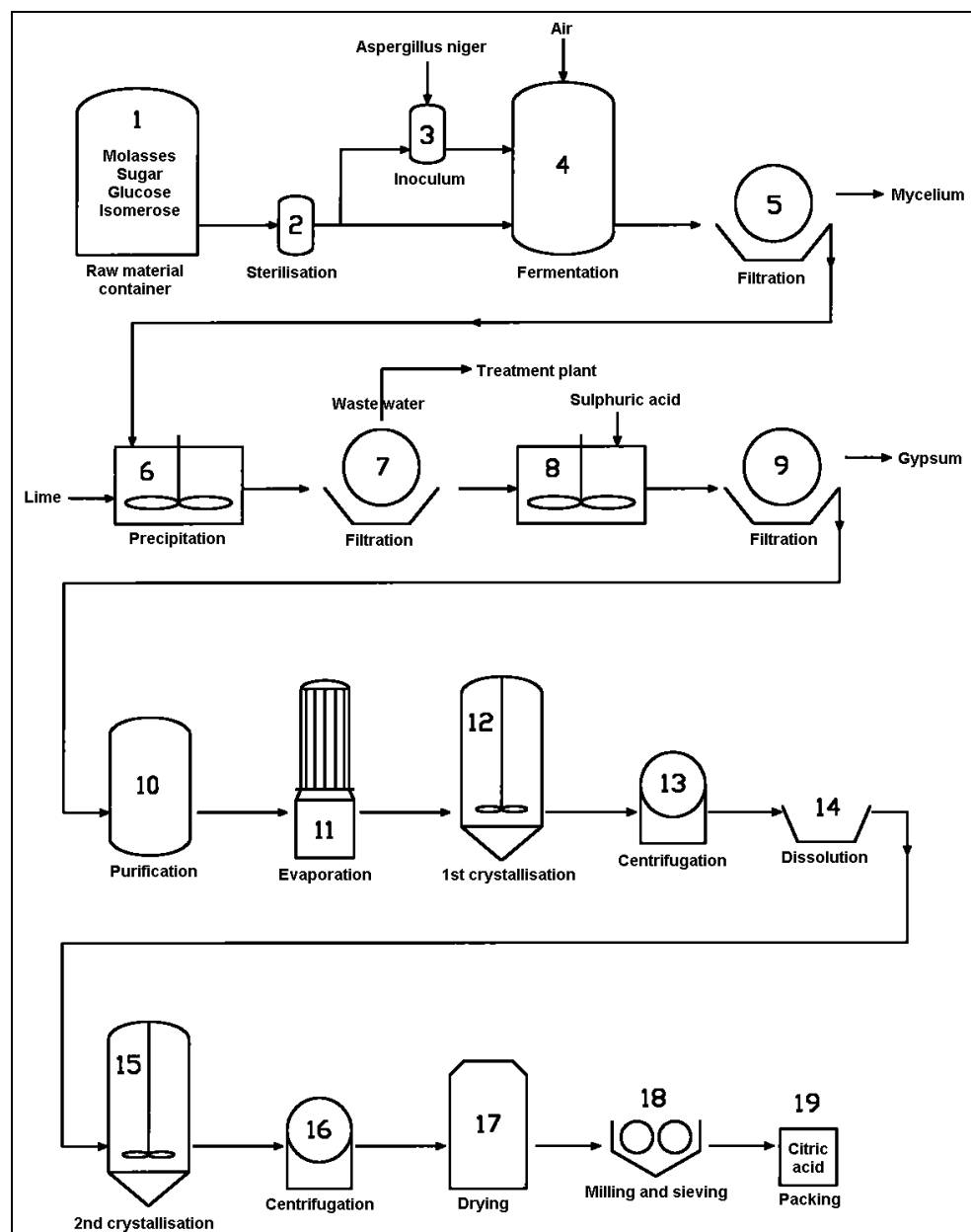

Figure 2.22: Citric acid fermentation process
[151, Austrian contribution, 2002]

3 CURRENT CONSUMPTION AND EMISSION LEVELS

This chapter presents the data and information provided about current consumption and emission levels in the FDM sector. Section 3.1 gives general information about consumption and emission levels in the whole sector. Section 3.2 gives more detailed information about the processing techniques and unit operations listed in Table 2.1. Section 3.3 reports data for specific FDM sectors.

In the FDM sector, energy, water and chemicals are consumed and gaseous, solid and liquid outputs are generated. These may have a negative impact on the environment and may be due to the inefficient use of materials or processes.

This chapter also contains information about outputs that are not the main final product and are not disposed of as waste. The FDM sector distinguishes between main products, co-products, by-products, returned products and waste, as shown in Figure 3.1. Normally the main product has the highest economic value.

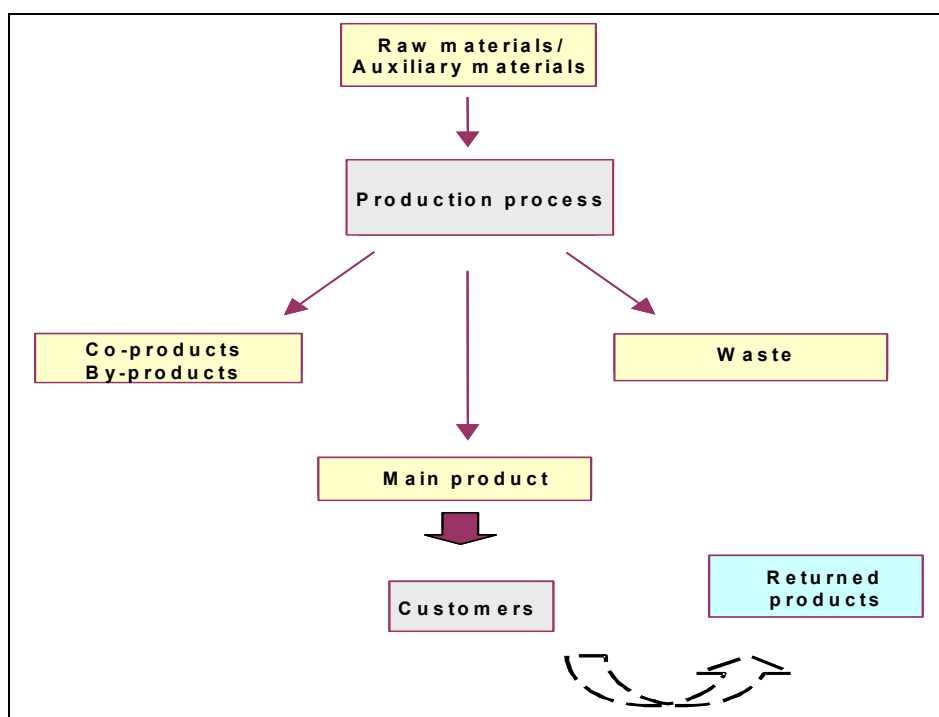

Figure 3.1: Output stream terminology used in the FDM sector
[1, CIAA, 2002]

In this document, co-products, by-products and returned products have the following meanings.

A co-product is a material, intentionally and unavoidably, created in the same process and at the same time as the main product. Both a main product and a co-product may each meet a set specification or design, and individually each is capable of being used directly for a particular purpose. For example, in the FDM sector some co-products are wheat gluten, maize gluten feed, maize gluten meal, maize germ, wheat feed, corn steep liquor, fruit pulp, concentrated fruit water, potato fibres, potato proteins, potato fruit water, malt culms, small barley and husks.

A by-product is a residual material which arises during the manufacture of a product. It may be used directly itself as an effective substitute for a product or may be used as an ingredient in another manufacturing process to create a different product, e.g. sludge and filter residues from filtration.

Returned products are those returned from retailers and wholesalers because they do not meet the required specification or because their shelf-life has expired.

The consumption and emissions information is important as part of the benchmarking process, and in the selection of techniques considered to be BAT.

Benchmarking is a technique used to assess performance against either internal or industry standards [11, Environment Agency of England and Wales, 2000]. Operational or technological improvement measures first applied at one site, may be applicable at others, even in different FDM sectors. These techniques may be considered in addition to comparing numerical consumption and emission levels.

Typically, benchmarks are expressed as ratios, but can be expressed as percentages, e.g. of efficiency. In this respect, data on waste minimisation, water and energy consumption, odour, noise and emissions to air and waste water, are generally relevant. Table 3.1 shows quantitative benchmarking parameters applicable in the FDM sector.

Performance monitor	Measurement
Air emissions	Mass of emission per unit of production or per unit of raw material
Waste water	Volume of water, mass of contaminants or BOD/COD per unit of production or per unit of raw material
Solid waste	Mass of waste per unit of production or per unit of raw material
Energy resources	Energy use per unit of production or per unit of raw material
Utilities and services	Use of water, compressed air or steam per unit of production or per unit of raw material
Other	Consumption of specific materials, e.g. packaging, per unit of production

Table 3.1: Quantitative benchmarking parameters applicable in the FDM sector [11, Environment Agency of England and Wales, 2000]

Data on water and energy consumptions vary, not only with the type of process and how it is operated, but also with the size of operation.

Data on emissions to air and water are available for some sectors and even for some processes within installations, but the latter are scarce. In the future, more detailed information may be available about emissions to air and water, when this is reported to the EC's European Pollutant Emission Register (EPER). This is a requirement under Commission Decision 2000/479/EC [221, EC, 2000]. Guidance from the EC [93, EC, 2000] includes an FDM sector-specific checklist for the pollutants likely to be emitted to air and water. For FDM activities under Annex I paragraph 6.4 of the IPPC Directive, six air pollutants, i.e. methane, carbon monoxide, carbon dioxide, HFCs, ammonia and NO_x, and four water pollutants, i.e. total nitrogen, total phosphorus, TOC and chlorides, are listed.

Within the FDM sector, the most common benchmarks compare utilities' consumption against production and, therefore, give a good indication of the efficiency and also of wastage occurring within the process. This is also called quantitative benchmarking. The percentage of raw materials going to the final main products is variable and waste minimisation is generally considered as a cost effective goal for all manufacturers but benchmarks are not readily available. Table 3.2 shows some examples of the percentages of raw materials which end up in the final main product.

Production process	% of raw material in the main final product
Fish canning	35 – 70
Fish filleting, curing, salting and smoking	25 – 50
Crustacean processing	40 – 50
Mollusc processing	50 – 80
Milk, butter and cream production	~99
Yoghurt production	94 – 98
Fresh, soft and cooked cheese production	10 – 15
White wine production	70 – 80
Red wine production	70 – 80
Fruit and vegetable juice production	50 – 70
Fruit and vegetable processing and preservation	70 – 95
Vegetable oils and fats production, i.e. crude vegetable oil, protein rich meal, lecithin and fatty acids from oilseeds	30 – 60
Maize starch production	62.5
Maize starch production (including animal feed)	99
Potato starch production	20
Potato starch production (including animal feed)	30 – 35
Wheat starch production	50
Wheat starch production (including animal feed)	99
Food and animal feed production from sugar beet	25 – 50

Table 3.2: Percentage of raw materials which end up in the final product in some processes [134, AWARENET, 2002]

3.1 General consumption and emission information

3.1.1 Water

3.1.1.1 Water consumption

Water consumption is one of the key environmental issues for the FDM sector. Water has many different uses, e.g:

- for cooling and cleaning
- as a raw material, especially for the drinks industry
- as process water, e.g. for washing raw materials, intermediates and products
- for cooking, dissolving and for transportation
- as auxiliary water, e.g. for the production of vapour and vacuum
- as sanitary water.

The quality of water needed depends on the specific use.

In 1998 in Germany, the total industrial water consumption was 8500 million m³ of which 304 million m³ was used by the FDM sector. Nevertheless, the actual amount of water used in the FDM sector in that period was reported to be 1730 million m³, i.e. more than the total consumption figure. This is because of the proportion of water that was recycled and re-used. On average, the number of times water was re-used in the German FDM sector increased from 3.4 times to 4.2 times between 1995 and 1998.

Of the 1730 million m³ of water used by the German FDM sector in 1998, 834 million m³, i.e. more than a half, was used as cooling water and 438 million m³ was used as process water. The amount of water used from various sources by the German FDM sector in 1998 is shown in Figure 3.2.

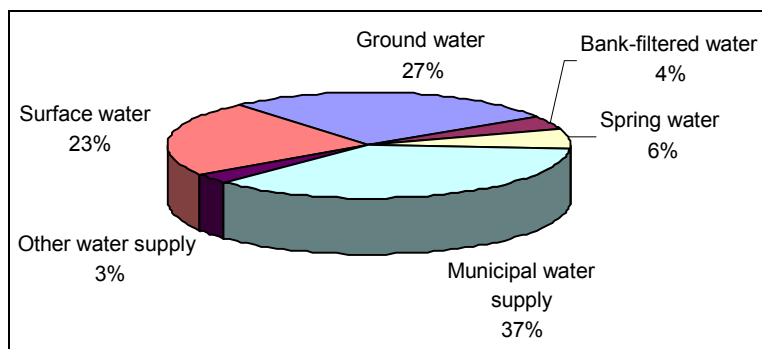

Figure 3.2: Water consumption by the German FDM industries in 1998 [182, Germany, 2003]

In the FDM sector as a whole, about 66 % of the total fresh water used is of drinking water quality. In some sectors, like dairies, soft drinks and mineral water manufacturing and breweries, up to 98 % of the fresh water used is of drinking water quality.

3.1.1.2 Waste water

Although the FDM sector is an extremely diverse sector, certain sources of waste water are common to many of its sectors. These include:

- washing of the raw material
- steeping of raw material
- water used for transporting or fluming raw material or waste
- cleaning of installations, process lines, equipment and process areas
- cleaning of product containers
- blowdown from steam boilers
- once-through cooling water or bleed from closed-circuit cooling water systems
- backwash from regeneration of the WWTP
- freezer defrost water
- storm-water run-off.

3.1.1.2.1 Quantity of waste water

The FDM sector has traditionally been a large user of water as an ingredient, cleaning agent, means of conveyance and feed to utility systems. Large FDM processing installations can use several hundred cubic metres of water a day. Most of the water not used as an ingredient, ultimately appears in the waste water stream.

Substantial reductions in the volume of waste water generated in this sector can be achieved through waste minimisation techniques (see, e.g. Section 4.1.7.6). There is no simple relationship between the amount of water used in cleaning and hygiene standards, and food safety legislation requirements prevent water use minimisation from causing unsatisfactory levels of cleanliness, hygiene or product quality.

Waste water flowrates may be very variable on a daily, weekly or seasonal basis. The waste water profile is largely dependent on production and cleaning patterns. In some sectors, e.g. sugar beet and olive oil production, processing takes place on a campaign basis and there is little or no waste water generated for part of the year.

3.1.1.2.2 Composition of waste water

FDM waste water is extremely variable in composition. It is, however, typically high in both COD and BOD. Levels can be 10 – 100 times higher than those of domestic waste water.

The BOD₅ content of the main FDM constituents and some products is shown in Table 3.3.

BOD ₅ content
0.65 kg/kg carbohydrate
0.89 kg/kg fat
1.03 kg/kg protein
0.07 – 0.10 kg/l milk
0.18 – 0.37 kg/kg meat
0.06 – 0.09 kg/kg fruit or vegetables

Table 3.3: BOD₅ equivalent of general FDM constituents and some products

The SS concentration varies from negligible to as high as 120000 mg/l. Waste water from, e.g. the meat and dairy sectors contain high concentrations of edible fats and oils.

Food processing waste waters vary from very acidic, i.e. pH 3.5, to very alkaline, i.e. pH 11. Factors affecting waste water pH include:

- the natural pH of the raw material
- pH adjustment of fluming water to prevent raw material deterioration
- use of caustic or acid solutions in processing operations
- use of caustic or acid solutions in cleaning operations
- acidic waste streams, e.g. acid whey
- acid-forming reactions in the waste water, e.g. high yeast content waste water, lactic and formic acids from degrading milk content
- nature of raw water source, either hard or soft.

Waste waters contain few compounds that individually have an adverse effect on WWTPs or receiving waters. Possible exceptions include:

- salt where large amounts are used, e.g. pickling and cheesemaking
- pesticide residues not readily degraded during treatment
- residues and by-products from the use of chemical disinfection techniques
- some cleaning products.

The presence of pathogenic organisms in the waste water may be an issue, particularly where meat or fish are being processed. The amount of plant nutrients may also be an issue. For the biological waste water treatment of the waste water, the ideal BOD:N:P ratio is about 100:5:1. At this level, FDM processing waste water would be too deficient in N and/or P to support biological activity during treatment. Excessive levels of P can also occur, particularly where large quantities of phosphoric acid are used in the process, e.g. vegetable oil de-gumming, or in cleaning. If such waste water becomes anaerobic during treatment then there is a risk that constituents containing phosphate could release phosphorus to the final discharge water. The use of nitric acid in the process produces a similar effect, thereby increasing the levels of nitrate in the waste water.

Some common sources of fugitive and unscheduled emissions, i.e. accidental releases, are:

- contaminated storm-waters
- storage tank leaks
- pipework leaks
- spillages
- bund drains
- leakages from flanges, pumps, seals and valve glands.

3.1.2 Air emissions

Air emissions can be divided into ducted, diffuse, and fugitive emissions. Only ducted emissions can be treated. Diffuse and fugitive emissions can, however, also be prevented and/or minimised [217, EC, 2003].

The sources of ducted emissions in the FDM sector are:

- process emissions, released through a vent pipe by the process equipment and inherent to the running of the installation, e.g. in frying, boiling, cooking operations
- waste gases from purge vents or preheating equipment, which are used only on start-up or shut-down operations
- emissions from vents from storage and handling operations, e.g. transfers, the loading and unloading of products, raw materials and intermediates
- flue-gases from units providing energy, such as process furnaces, steam boilers, combined heat and power units, gas turbines, gas engines
- waste gases from emission control equipment, such as filters, thermal oxidisers or adsorbers
- waste gases from solvent regeneration, e.g. in vegetable oil extraction installations
- discharges of safety relief devices, e.g. safety vents and safety valves
- exhaust of general ventilation systems
- exhaust of vents from captured diffuse and/or fugitive sources, e.g. diffuse sources installed within an enclosure or building.

The sources of diffuse emissions in the FDM sector are:

- process emissions by the process equipment and inherent to the running of the installation, released from a large surface or through openings
- working losses and breathing losses from storage equipment and during handling operations, e.g. filling of drums, trucks or containers
- emissions from flares
- secondary emissions, resulting from the handling or disposal of waste, e.g. volatile material from sewers, waste water handling facilities or cooling water.

The sources of fugitive emissions in the FDM sector are:

- odour losses during storage, filling and emptying of bulk tanks and silos
- stripping of malodorous compounds from a WWTP resulting in releases to air and/or odour problems
- storage tank vents
- pipework leaks
- fumigation
- vapour losses during storage, filling and emptying of bulk solvent tanks and drums, including hose decoupling
- burst discs and relief valve discharges
- leakages from flanges, pumps, seals and valve glands
- building losses from windows, doors, etc.
- settling ponds
- cooling towers and cooling ponds.

The main air pollutants from FDM processes, not including the pollutants released in associated activities such as energy production, are:

- dust
- VOCs and odour (some caused by VOCs)
- refrigerants containing ammonia and halogen
- products of combustion, such as CO₂, NO_x and SO₂.

3.1.2.1 Odour

Odour is mostly a local problem. Some air emissions which are harmful may also be malodorous. For two identical installations producing the same products and using the same raw materials and process operations, one may be subject to considerable complaints whilst for the other, the odour emission may not be a problem. There are many cases where installations, previously situated in rural areas on the outskirts of a town or city, are now faced with odour problems as new housing estates have been constructed near the site as the town has grown.

In the vast majority of countries, odour emissions are regulated under the laws of nuisance. Some countries have quantified legislation. This quantified legislation can relate to either the magnitude of the malodorous emission or alternatively to a maximum concentration of a component or group of components which are known to cause malodorous emissions. The internationally accepted units of odour are “odour units per cubic metre” (OU/m³). Instrumental odour measurements exist but the quantification of odour is still based on olfactometry to a great extent.

In Germany, e.g. the legislation for malodorous processes is largely directed towards ensuring that the outlet concentration of organics is limited in relation to the process being conducted and the efficiency of the chosen abatement plan. The legislation, under TA Luft [82, BMU and German Federal Ministry for Environment Nature Conservation and Reactor Safety, 1986], contains a general statement about odour emissions and describes the need to consider containment, the surroundings and the ability of the abatement plan to achieve 99 % odour reduction for odour emissions greater than 100000 OU/m³. For specific process operations TA Luft provides maximum outlet concentrations of organics that should not be exceeded.

The Netherlands Emissions Guideline for Air [170, InfoMil, 2001], states that the national goal is the prevention or reduction of odour nuisance. It sets an upper limit of 5 OU/m³ as 98 % for existing installations and suggests that a limit of 0.5 OU/m³ as 99.5 % will have to be satisfied for new installations; the latter is not an upper limit.

3.1.3 Loss of materials

3.1.3.1 Exceed weight/volume specification

Loss of products by overfilling occurs even with the most accurate filling equipment. Operating to average filling weight legislation, the packaged product will unavoidably contain marginally more than the nominal package contents. Because of its economic significance, overfill is normally very closely monitored by check-weighing on a continuous or sampling basis. Such loss of material is normally of no environmental significance. It is, however, very important when conducting a mass balance, to accurately quantify the amount of overfill, so that this can be allowed for in the mass balance equation.

3.1.3.2 Spillage

Spillage of the product, e.g. onto the floor, results in the product being unfit for human consumption and must be defined as loss and waste, if not properly recovered. Routinely occurring spillage indicates poor equipment design, poor maintenance or poor operation, e.g. of a packaging line. This often causes a considerable loss of product and packaging material. When spillage occurs during manual handling, the working procedures may be at fault.

3.1.3.3 Leakage/overflow

Leakage of liquid product from pipe joints and overflow from tanks may be an important source of loss of material and waste, if not properly recovered. These problems can be caused, e.g. by obsolete gaskets or faulty high level alarm switches.

3.1.3.4 Product defects/returned product

Products not meeting the required specification, whether identified prior to dispatch or returned by customers, can be a major source of loss of materials and waste, although some may be recovered. This group also includes over-produced fresh products, e.g. in cases where order fluctuations result in too much product being produced which cannot then all be sold in time due to shelf-life considerations.

3.1.3.5 Inherent loss

Some process equipment, even with the most appropriate technique, can cause a loss of materials and waste which is unavoidable by design. An example of inherent loss is the self-desludging centrifugal separator, where solids from the bowl, and inevitably some product, are flushed to waste during desludging.

A similar situation exists where the product is purged through the equipment with water at the end of production or at product change-over, e.g. in CIP systems. Inevitably the interface between the product and the water will not be sharp and depending on what measures are taken to minimise this, a greater or lesser quantity of a mixture of the two is produced.

3.1.3.6 Retained material

Retained material occurs when liquid products or ingredients cannot freely drain to the next stage in the process. This can, e.g. be caused by dips in supposedly continuously falling pipelines, which trap the product and prevent it from draining either way. Another example is where the product rises in the pipelines and any trapped product will then not drain away, thus leading to a loss of material. If the product cannot drain, then it must be purged with gas, water or a pigging system.

Also, with very viscous products, e.g. yoghurt, adhesion to the pipeline and tank walls is a significant source of retained material. Unless mechanically removed, e.g. by pigging, prolonged pre-rinsing is likely to be required.

3.1.3.7 Heat deposited waste

Whenever liquid products are heated, there is a likelihood of deposition of the product onto the heat-exchange surface. Deposits on the plates or tubes in heat-exchangers, and on batch kettles may not rinse off and when removed with detergents is lost in the waste water. In many sectors, these sources of loss are contained and recycled or recovered back into the process.

3.1.4 Energy

The FDM sector depends on energy for processing, storage, to maintain freshness and to ensure food safety. Process heating uses approximately 29 % of the total energy used in the FDM sector. Process cooling and refrigeration accounts for about 16 % of the total energy used.

In Germany, the FDM sector consumed about 54500 MWh/yr in 1998, representing 6.7 % of the total German energy consumption making it the fifth largest energy consumer among all industrial sectors. The energy was produced using 49 % gas, 23 % electricity, 21 % oil, and 7 % coal. The energy consumption doubled in 30 years from 1950 to 1980. There was a slight decrease in the 1980s and 1990s [2, Meyer, et al., 2000].

3.2 Consumption and emissions in unit operations

It is quite difficult to give quantitative data on the environmental aspects of individual processing techniques. This is due to a lack of reliable data or due to natural variations, e.g. seasonal, in many of the raw materials. This often leads to changes in the processing techniques applied. The ranges in the quantitative data are very largely due to the very wide variation in individual process applications. Often better quantitative information is available on the environmental aspects of the whole production line rather than on individual processing techniques, because measurements have not been made at unit operation level.

Examples are given of some qualitative and quantitative environmental aspects of typical production lines. In the description of environmental aspects of the various processing techniques, “solid output” covers both by-products from the process which could be valorised, as well as waste which cannot be valorised. For example, some by-products from the FDM sector can be used as animal feed.

The main sources of consumption and emissions are identified for each processing technique. The identified list of sources is not all encompassing, or every installation within an individual sector have every one of the emissions. The information is associated with the FDM sector as a whole. Local variations apply, depending on the raw materials used, the type of processes applied and how they are applied.

Some process emissions are considered to have little potential environmental significance and these are designated as minor, however, there could be specific installations where this designation may be incorrect. Such emissions must then be examined on a case-by-case basis.

The environmental impacts or process emissions for each of the unit operation described in Section 2.1 are summarised in Table 3.4. The symbols alongside each operation describe the characteristic of the emission. The meaning of the codes used are given in Table 3.5, Table 3.6 and Table 3.7.

Code	Unit operation	Environmental impact		
		Air	Water	Solid
A. Materials reception and preparation				
A.1	Materials handling and storage			W1
	Tank vents	S1, S3	N	N
	Silos	S2	N	N
	Material handling/transport	S1, S2, S3	E1, E2, E3, E4, E5	W1
A.2	Sorting/screening, grading, dehulling, destemming/destalking and trimming	S1, S2	E1, E2	W1, W3
A.3	Peeling	N	E1, E2	W1
A.4	Washing	N	E1, E2	W1
A.5	Thawing	N	E1, E2	W1
B. Size reduction, mixing, forming				
B.1	Cutting, slicing, chopping, mincing, pulping and pressing	N	E1, E2, E4	W1, W2
B.2	Mixing/blending, homogenisation and conching	S1, S2, S3	E1, E2, E4, E5	W1
B.3	Grinding/milling and crushing	S2, S3	N	W1, W3
B.4	Forming/moulding and extruding	N	E1, E2, E5	W1
C. Separation techniques				
C.1	Extraction	S1, S3	E1, E2	W1, W4
C.2	Deionisation	N	E1, E3, E5	W1
C.3	Fining	N	E1, E2	W1, W3
C.4	Centrifugation and sedimentation	N	E1, E2	W1, W3
C.5	Filtration	M	E1, E2, E4	W1, W3
C.6	Membrane separation	N	E1, E2	N
C.7	Crystallisation	N	E1	N
C.8	Removal of free fatty acids by neutralisation	N	E1, E2, E3, E4	N

C.9	Bleaching	N	N	W1,W3
C.10	Deodorisation by steam stripping	S1, S3	E1, E2, E4	W2
C.11	Decolourisation	N	E1,E2	W1
C.12	Distillation	S1, S3, S4	E1,E2	W1
D. Product processing technology				
D.1	Soaking	N	E1, E2	W1
D.2	Dissolving	N	E1, E2, E6	N
D.3	Solubilisation/alkalising	S1, S2, S3	E1,E2	N
D.4	Fermentation	S1,S4	E1,E2	W1
D.5	Coagulation	N	E1, E2	N
D.6	Germination	S3	N	N
D.7	Brining/curing and pickling	N	E1, E2, E6	W1
D.8	Smoking	S1, S3	E1	N
D.9	Hardening	S1	E1, E2, E4	W5
D.10	Sulphitation	S6	N	N
D.11	Carbonatation	S1, S4, S5, S6, S7	N	W3
D.12	Carbonation	S4	N	N
D.13	Coating/spraying/enrobing/agglomeration/ encapsulation	S1	E1, E2, E4	W1, W2
D.14	Ageing	S1, S3	E1,E2	W1, W6
E. Heat processing				
E.1	Melting	S1	E1, E2, E4	W1, W2
E.2	Blanching	S1	E1, E2, E6	W1
E.3	Cooking and boiling	S1, S3	E1, E2, E4, E5, E6	W1
E.4	Baking	S1, S2, S3, S4	E1, E2, E4	W1
E.5	Roasting	S1, S2, S3, S4, S5	N	W1
E.6	Frying	S1, S3	E1, E2, E3, E4	W1, W2
E.7	Tempering	N	E1,E2	N
E.8	Pasteurisation, sterilisation and UHT	N	E1, E2	W1
F. Concentration by heat				
F.1	Evaporation (liquid to liquid)	S1, S2	E1, E2, E5	N
F.2	Drying (liquid to solid)	S1, S2	E1, E2	W1
F.3	Dehydration (solid to solid)	S1, S2	E1, E2	W1
G. Processing by removal of heat				
G.1	Cooling, chilling and cold stabilisation	S4	M	N
G.2	Freezing	S4, S7	N	N
	Cryoextraction	N	E1	W1, W3
	Concentration by cold	N	E1	N
G.3	Freeze-drying/lyophilisation	N	E2	N
H. Post processing operations				
H.1	Packing and filling	S2	E1, E2	W1, W6
H.2	Gas flushing and storage under gas	S4	N	N
U. Utility processes				
U.1	Cleaning and disinfection	N	E1, E2, E3, E4, E5	N
U.2	Energy generation and consumption	S2, S4, S5, S6	N	N
	Boiler blowdown	N	E5	N
U.3	Water use			
	Demineralisation plant	N	E1, E2, E3, E5	W1, W3
U.4	Vacuum generation	S1	E1	N
U.5	Refrigeration	S7	E5	N
U.6	Compressed air generation	N	N	N

Table 3.4: Environmental impacts of the FDM unit operations [1, CIAA, 2002]

Code	Emissions to air
S1	Odour
S2	Dust
S3	Organics*
S4	CO ₂
S5	NO ₂
S6	SO ₂
S7	NH ₃
M	Minor
N	None

* Organics covers emissions containing organic material at the actual processing conditions and is regardless of the vapour pressure of the individual components present in the emission

Table 3.5: Codes used for emissions to air
[1, CIAA, 2002]

Code	Emissions to water
E1	Soluble organic material (BOD/COD)
E2	Total suspended solids
E3	Acid/alkali
E4	FOG
E5	Nitrate, nitrite, ammonia, phosphate
E6	Dissolved solids
M	Minor
N	None

Table 3.6: Codes used for emissions to water
[1, CIAA, 2002]

Code	Solid outputs
W1	Organic, e.g. waste product/processing materials
W2	Oils/fats/greases
W3	Inorganic, e.g. soil, calcium carbonate and bleaching earth
W4	Solvent
W5	Metals, e.g. nickel catalyst
W6	Packaging from process operations, e.g. paper, cardboard or drums
M	Minor
N	None

Table 3.7: Codes used for solid outputs
[1, CIAA, 2002]

3.2.1 Materials handling and storage (A.1)

3.2.1.1 Water

The main release into water is caused by leakages. During the transport by water of solid raw materials, such as vegetables, roots and tubers, both organic and inorganic SS and soluble compounds are released to water. Cleaning of the various pipes and storage tanks also contributes to water usage and waste water load. The waste water may also contain acid/alkali solutions, FOG, nitrate, nitrite, ammonia and phosphate.

3.2.1.2 Air emissions

Emissions to air can occur from vessel vents during filling, and/or conveying by air. These emissions may include dust, VOCs and odours, which are usually minor in quantity and local in effect.

3.2.1.3 Solid output

Some solid residues can result from vessels or other material handling equipment and from packaging. They can be, e.g. re-used in the installation or elsewhere, sold as animal feed or may be disposed of as waste.

3.2.1.4 Energy

Materials handling is almost exclusively electrically driven. No significant heat is involved. The environmental issues are minor and relate to electrical consumption.

3.2.1.5 Noise

Short periods of noise may occur from certain types of vehicle-mounted blowers used to discharge solids and liquids from road vehicles into silos and other vessels.

3.2.1.6 Accidental release

Accidental releases can occur, e.g. during unloading when connecting or disconnecting hoses and during storage if valves are not fully closed or maintained.

3.2.2 Sorting/screening, grading, dehulling, destemming/destalking and trimming (A.2)

3.2.2.1 Water

Wet screening may result in a waste water stream containing soluble organic matter and SS.

3.2.2.2 Air emissions

When dry cleaning food/agricultural raw materials, dust may be produced. Odour may also be a problem. These emissions are minor in quantity and local in effect.

3.2.2.3 Solid output

Material that is sorted out, or removed, is usually recovered as far as possible and then often used as animal feed. If the material cannot be used, it is disposed of as waste.

3.2.2.4 Energy

Although sorting generally needs little energy, there are large variations in electrical energy consumption. For example, in vegetable processing, the sorting operation has an electrical energy consumption of 0 – 20 kWh_e/t frozen vegetable. [32, Van Bael J., 1998]

3.2.3 Peeling (A.3)

3.2.3.1 Water

In most peeling operations, a water spray is used to remove the peeled skin. Waste water is generated which contains SS. Conventional steam or hot water peeling uses large quantities of water, up to four times that required for caustic peeling, and produces waste water with high levels of product residue. At potato processing installations, the peels can contribute up to 80 % of the total BOD. In fruit processing, peeling waste water can account for as much as 10 % of the total waste water flow and 60 % of the BOD. Dry caustic peeling methods can greatly reduce the volume and strength of the waste water from this operation and allow for the collection of peel as a pumpable slurry. The use of caustic in peeling may lead to pH fluctuations in the waste water. Some produce, e.g. tomatoes, requires strong caustic solutions and the addition of wetting agents. Dry caustic peeling tends to have a lower caustic consumption than wet methods. In steam peeling, most of the peeled material is discharged with the steam; this results in the collection of a concentrated waste stream. Remaining traces are sprayed off with water. The process has a lower water consumption than other “wet” peeling methods.

3.2.3.2 Air emissions

When flame peeling is applied, some dust and odour emissions can occur.

3.2.3.3 Solid output

The peels are often recovered and used as animal feed, otherwise they are disposed of as waste.

Abrasion peeling has a significantly higher product loss than flash steam peeling, 25 % loss compared to 8 – 15 % loss, and considerably more waste water is produced. In caustic peeling, product loss is around 17 %. Dry caustic peeling reduces water consumption and produces a concentrated caustic paste for disposal.

3.2.3.4 Energy

Flash steam peeling, caustic peeling and flame peeling require heat; the other peeling operations use electrical energy.

3.2.3.5 Noise

Noise emissions may be a problem.

3.2.4 Washing (A.4) and thawing (A.5)

3.2.4.1 Water

Water is required and the waste water typically contains dissolved organic matter, SS and salts.

3.2.4.2 Solid output

The dirt and vegetable matter removed during the washing of, e.g. sugar beets and potatoes, is sent for landspreading or for landfilling.

3.2.4.3 Energy

The electricity consumption for washing operations heavily depends on the vegetable concerned. Washing spinach, for instance, is energy intensive.

During washing operations, hot water can be used to increase the speed and efficiency of the washing. Most companies do not heat the water. Sometimes hot residual water from the blanching system is used for washing [32, Van Bael J., 1998]

Thawing using hot air consumes energy.

3.2.5 Cutting, slicing, chopping, mincing, pulping and pressing (B.1)

3.2.5.1 Water

Waste water results mainly from the cleaning of equipment. It usually contains soluble organic material, such as small particles of meat, fruit and vegetables. In meat processing, the waste water may also contain soluble proteins, FOG and other solids, such as curing salts.

3.2.5.2 Solid output

The by-products generated depend on the raw material and process, e.g. in meat cutting, typical by-products are bones, fat and skin. These are usually used for other manufacturing processes, which might even be outside the FDM sector, such as soap manufacture. Other typical outputs include fruit and vegetable peelings.

3.2.5.3 Energy

Electrical energy is used for various equipment.

3.2.5.4 Noise

Some high-speed, power-operated equipment is used which can generate high noise levels, e.g. circular saws used to cut through bones and bowl cutters. However, this is usually not an issue, as the noise typically does not carry to off-site receptors.

3.2.6 Mixing/blending, homogenisation and conching (B.2)

3.2.6.1 Water

The use of water in this group of operations is normally restricted to cleaning the equipment. The amount used depends on the type of equipment. The resulting waste water contains soluble organic material, SS, FOG and may also contain nitrate, nitrite, ammonia and phosphate.

3.2.6.2 Air emissions

In operations where solid and volatile materials are treated, emissions to air can occur. Odour may be produced by operations which involve VOCs. Dust is emitted in operations involving solids such as solid/solid mixing.

3.2.6.3 Solid output

In operations where solid materials are processed, solid organic output may be generated when equipment is emptied for the next batch or for cleaning. Normally some losses occur during such operations. This solid waste can consist of raw materials or waste products. By careful operation and good housekeeping, the amount of solid output can often be reduced and any output resulting may be re-used or sold as animal feed.

3.2.6.4 Energy

These unit operations require mainly electrical energy input.

3.2.6.5 Noise

Homogenisation may be a source of noise.

3.2.7 Grinding/milling and crushing (B.3)

3.2.7.1 Water

Wet grinding consumes large quantities of water.

3.2.7.2 Air emissions

Dust is emitted in operations involving solids. VOCs may also be emitted.

3.2.7.3 Solid output

Solid organic output is generated when equipment is emptied for the next batch or for cleaning. Some losses occur during such operations. This solid output can consist of raw materials or waste products and can be reprocessed or sold as animal feed.

3.2.7.4 Energy

Grinding requires a significant energy input.

3.2.7.5 Noise

Grinding is a source of noise.

3.2.8 Forming/moulding and extruding (B.4)

3.2.8.1 Water

Waste water is generated during the cleaning of equipment and contains primarily soluble organic material and SS and may also contain nitrate, nitrite, ammonia and phosphate.

3.2.8.2 Air emissions

Extrusion at high temperatures may result in some air emissions of VOCs and odour.

3.2.8.3 Solid output

Some solid waste may be generated due to the loss of product at the beginning and end of the production process.

3.2.8.4 Energy

Typically, extruders are major users of electrical energy.

3.2.9 Extraction (C.1)

3.2.9.1 Water

Water usage is an issue when water is used as a solvent in the extraction process. Also, extraction equipment is cleaned periodically to ensure efficient and optimum operating conditions. The frequency of cleaning depends on the product and extractor design. This cleaning will generate waste water containing soluble and insoluble organic material and SS.

For example, in the extraction process of oil from oilseeds with hexane, cooling water is needed in an amount of 0.2 to 14 m³/t oilseed. Furthermore, a certain amount of waste water is generated, mainly from the hexane/water separation, which amounts to 0.2 to 0.5 m³/t oilseed; the load being of 0.1 to 1 kg COD/t oilseed. The amounts of water consumption and of pollution depend on the cooling water system, e.g. once-through or with recycling, and on the kind of oilseeds. The throughput rate of the toaster also has a major influence on these parameters. Water consumption for the pressing of oil is minimal.

3.2.9.2 Air emissions

Extraction with organic volatile solvents may cause emissions of VOCs. Council Directive 1999/13/EC [157, EC, 1999] includes provision for oilseed extraction, including VOC emission limit values for vegetable oil and animal fat extraction, and vegetable oil refining activities.

Extraction plants may also cause odour, due to the emission of H₂S and organic compounds. When extraction with water takes place, water vapour containing non-condensable VOCs may be released to the air.

3.2.9.3 Solid output

The solid output may be re-used as a product or co-product, or be disposed of. For example, after the removal of the adhering water, spent coffee grounds can be burned as fuel in steam boilers or used as raw material for further processing. The solid output may contain solvents.

3.2.9.4 Energy

Electrical energy and steam are required; the levels depend on the type of application. For example, energy consumption is of 170 – 390 kWh steam (600 to 1400 MJ) and 30 – 60 kWh_e/t oilseed (100 to 200 MJ). The energy consumption depends mainly on the kind of oilseed and of the type of cooling water circuit.

3.2.9.5 Noise

Possible sources of noise are cooling towers, fans and steam safety valves.

3.2.10 Deionisation (C.2)

3.2.10.1 Water

The regeneration of ion exchange columns produces water containing the chemicals used for regeneration, usually acids or alkalis and brine; ions removed from the product, minerals and impurities extracted from the used column. The pH of the waste water fluctuates. Regeneration starts with rinsing the ion exchange columns with water. This produces waste water containing soluble organic material and product residues, which depending upon their dilution, may be reprocessed.

3.2.10.2 Solid output

The only solid output is the ion exchange resin at the end of its useful life. This can be anything from 6 months to 10 years depending on the operation and product, and the type of ion exchange resin used.

3.2.11 Fining (C.3)**3.2.11.1 Water**

Waste water is produced which contains soluble organic material and SS.

3.2.11.2 Solid output

Solid output is produced which contains organic and inorganic material.

3.2.12 Centrifugation and sedimentation (C.4)**3.2.12.1 Water**

Water is used periodically to clean the separation equipment. The frequency of cleaning and the volumes of water used vary depending on the product and the equipment. Sometimes the water can be reprocessed. Waste water is produced from cleaning the equipment, as well as in the form of separated waste products from the operational process, which will contain dissolved organic material and SS.

3.2.12.2 Solid output

Centrifugal separator sludges may sometimes be re-used in the process or may otherwise have to be disposed of. The sludges produced contain organic and inorganic material.

3.2.12.3 Energy

Centrifugation uses significant amounts of energy. When sedimentation is used, electrical energy is required for pumping operations.

3.2.12.4 Noise

The operation of centrifuges may involve relatively high levels of noise in close proximity to the machines and, therefore, suitable control measures need to be put in place.

3.2.13 Filtration (C.5)**3.2.13.1 Water**

Depending on the end purpose of the filtration operation, the process may result in waste water containing dissolved organic material, SS and FOG.

3.2.13.2 Air emissions

The air discharge from the vacuum pump during vacuum filtration may contain dust. These emissions are minor in quantity.

3.2.13.3 Solid output

Filter residues arise and require a suitable method of recovery or disposal, e.g. bleaching earth in edible oil refining or diatomaceous earth in a brewery.

3.2.13.4 Energy

Pumping requires electrical energy.

3.2.14 Membrane separation (C.6)

3.2.14.1 Water

Water is used periodically to clean the separation equipment. The frequency of cleaning and the volumes of water used vary depending on the product and equipment. Waste water is produced from washing as well as in the form of separated waste products from the process, and contains dissolved organic material and SS.

3.2.14.2 Energy

Membrane separation is a pressure driven process, so electrical energy is required. In electro dialysis, electrical energy is required for the transport of ions.

3.2.15 Crystallisation (C.7)

3.2.15.1 Water

In crystallisation operations, water is used for cooling and is normally recirculated. Depending on the cooling requirements, water is recirculated via chilling units, cooling towers or cooling ponds. Waste water containing soluble organic material is generated after the removal of crystals.

3.2.15.2 Solid output

In the refinery process, active carbon is used if required. Spent active carbon is either regenerated or disposed of as waste.

3.2.15.3 Energy

Electricity is needed to power the pumps and drives. Energy is needed for the cooling system.

3.2.16 Removal of free fatty acids by neutralisation (C.8)

3.2.16.1 Water

The neutralisation process requires cooling water. The waste water that results from a combined neutralisation and soap-stock splitting has a temperature of about 100 °C, high acidity and contains salts of sodium sulphate or sodium chloride and sodium phosphate in high concentrations. If citric acid is used, this increases the BOD load of the waste water. The disposal of process waste water with high concentrations of sulphates (>2000 mg/l) into a MWWTP may cause corrosion of the concrete. Phosphorus levels may be high. The waste water may also contain FOG.

3.2.16.2 Air emissions

The soap-stock acidulation system may be a source of odour.

3.2.16.3 Solid output

Fatty acids are considered a by-product. The treatment of a neutralisation waste water can produce high amounts of sludge, due to the presence of phosphates and/or sulphates. The waste water may have high salt concentrations.

3.2.16.4 Energy

The steam generation required as the main source of energy for neutralisation and soap-stock splitting consumes significant amounts of energy.

3.2.17 Bleaching (C.9)**3.2.17.1 Air emissions**

There may be odour emissions.

3.2.17.2 Solid output

The solid output from bleaching is known as spent earth. Due to its high oil content, there is a risk of self-ignition. The spent earth of an oil refinery can be added to the meal formed by crushing to make a by-product. The spent earth used for bleaching hardened oils can also be added to the meal, as long as it does not contain nickel and/or activated carbon. Otherwise, as it has a high calorific value, it is used as an energy source, e.g. in the production of concrete or to produce biogas.

3.2.17.3 Energy

Steam is needed for oil recovery from the spent bleaching earth. The oil and spent bleaching earth are heated by steam during the bleaching process.

3.2.18 Deodorisation by steam stripping (C.10)**3.2.18.1 Water**

Water is used for cooling the condensers. The water from the barometric condensers may be polluted. In a once-through barometric condenser, the heat load to the surface water is equivalent to the steam consumption in the vacuum system. The waste water produced contains soluble organic material, SS and FOG.

3.2.18.2 Air emissions

Vacuum pumps release organic compounds that may cause odour problems.

3.2.18.3 Solid output

Fatty acids and distillates are produced by this process. These are, in most cases, considered as by-products.

3.2.18.4 Energy

For this processing technique, energy is needed in the form of steam and electricity. The electrical energy consumption ranges from 17 – 42 kWh/t product (60 – 150 MJ/t), and steam consumption from 115 – 310 kWh/t product (420 – 1120 MJ/t).

3.2.18.5 Noise

Noise issues may arise from the cooling tower fans.

3.2.19 Decolourisation (C.11)

3.2.19.1 Water

During start-up and shut-down, low volumes of aqueous product may be discharged which contain low quantities of solid matter. In some cases this discharge is reprocessed/re-used in the process. However, it is not always economical to concentrate this material, in which case it is discharged as waste water. This waste water may contain dissolved organic material, SS and dissolved solids.

3.2.19.2 Solid output

The decolourisation process produces a filter residue consisting of the active material, any filter aid used and some residual product. This solid output is sometimes sent to landfill or for landspreading/composting depending on its nature. Depending on the type of process/product, this solid output can also be used as animal feed.

3.2.19.3 Energy

Any heating of the product used to meet the optimum conditions for the operation can usually be recovered by normal heat recovery systems. The regeneration of activated carbon involves kilning at elevated temperatures in the absence of oxygen. This is mainly done off site by specialised companies.

3.2.20 Distillation (C.12)

3.2.20.1 Water

A residual liquid such as stillage, pot ale, spent lees and spent wash, is discharged from the stills. The waste water contains SS and very high BOD levels. Where recovery systems exist, a proportion of the stillage may be re-used.

3.2.20.2 Air emissions

Emissions to air include dust, VOCs and odour. There may be minor emissions of uncondensable volatiles, mainly carbon dioxide and ethanol from column stills. There are no issues for pot stills.

3.2.20.3 Solid output

Concentrated stillage or dried stillage may be used in animal feed, as a feedstock in sugar and grain-based production, sent for landspreading or otherwise disposed of as waste. Solid outputs are also used for methane production, the gas being used for energy production. This can improve the energy balance in the distillation process.

3.2.20.4 Energy

The distillation tower is heated by steam. For pot stills, 12 to 13 kWh per litre of pure alcohol is required.

3.2.20.5 Noise

Some of the production equipment may emit high noise levels, e.g. during the concentration of stillage or the dehydration of alcohol by molecular sieve adsorption.

3.2.21 Soaking (D.1)**3.2.21.1 Water**

For soaking, water is required and consequently some waste water containing dissolved organic material and SS is produced.

3.2.21.2 Solid output

Some dirt can be produced, although this is usually removed during soaking. Organic solid output may also be produced.

3.2.22 Dissolving (D.2)**3.2.22.1 Water**

Waste water is generated during cleaning. This waste water may contain product residues, e.g. powder and oil from rinsing, resulting in dissolved organic material, dissolved solids and SS in the waste water.

3.2.22.2 Air emissions

Dust emissions may occur during bag tipping. These emissions are typically minor and generally remain inside buildings.

3.2.22.3 Energy

During the dissolving process, steam and electricity are used.

3.2.23 Solubilisation/alkalising (D.3)**3.2.23.1 Water**

Waste water is generated from the cleaning of equipment and typically contains soluble organic material, SS and FOG.

3.2.23.2 Air emissions

Air emissions typically consist of water vapour containing low concentrations of VOCs and dust. Odour may also be a problem.

3.2.23.3 Energy

An example of the typical energy requirements per tonne of cocoa is shown in Table 3.8.

	Electrical power (kJ/kg)	Electrical power (kWh/kg)	Steam (kg/t)	Steam (kWh/t)
Liquid process	35 – 70	0.010 – 0.019	300 – 500	233 – 389
Nips alkalising	35 – 550	0.010 – 0.153	700 – 1000	548 – 778

Table 3.8: Typical energy requirement per tonne of cocoa
[1, CIAA, 2002]

3.2.24 Fermentation (D.4)

3.2.24.1 Water

Water is used for cooling the fermentation vessels. Usually, cooling water from the cooling towers or a dedicated once-through system is used. Waste water is generated from cleaning the equipment and vessels. This generally contains raw material and fermented product residues. Yeast, as an organic product, has a high COD and SS content and is a major contributor, along with the carrying liquid phase, to the COD load of the waste water.

3.2.24.2 Air emissions

Emissions to the air are alcohol and CO₂, which is a natural product of alcoholic fermentation. Within controlled fermentation processes, it is generally common practice to vent these emissions to the air, although recovery and re-use may also take place. Odour may also be a problem.

3.2.24.3 Solid output

Brewers' yeasts are a by-product, with common secondary uses as food products or animal feed.

3.2.24.4 Energy

Electrical energy is needed to circulate the cooling water.

3.2.25 Coagulation (D.5)

3.2.25.1 Water

Water is needed for curd washing. Waste water is generated during the cleaning of the equipment and contains dissolved organic material and SS.

3.2.25.2 Energy

Steam energy is needed for heat treatment and electricity is needed for cooling.

3.2.26 Germination (D.6)

3.2.26.1 Water

Some water is required for the humidification of air.

3.2.26.2 Air emissions

The air from the germination process is loaded with water vapour and minor amounts of VOCs, which may emit odour.

3.2.26.3 Energy

Energy is needed for conditioning and circulating the air.

3.2.27 Brining/curing and pickling (D.7)

3.2.27.1 Water

Brine that is discarded after use, or excess brine from immersion baths, is discharged as waste water. The quantity discharged depends on the method of brining or curing used. This waste water contains salt, curing salts and other ingredients, and also soluble product components, such as protein which is exuded from the product during brining. The cleaning of premises and equipment also generates waste water containing residual curing ingredients, product residues, dissolved organic material, dissolved solids and SS.

3.2.28 Smoking (D.8)

3.2.28.1 Water

The waste water generated during cleaning contains soluble organic material, residues from the chemical components of the vapour and the liquid phases of the smoke, as well as cleaning chemicals.

3.2.28.2 Air emissions

Strong odours are produced during the smoking and drying operations. Emission is much higher during the smoking stage than during the drying step. The vented smoke also contains VOCs. Some installations remove odours from the smoke before it is emitted to the air.

3.2.28.3 Solid output

Ashes from wood.

3.2.28.4 Energy

Energy is needed for smoke generation and for heating and drying.

3.2.29 Hardening (D.9)

3.2.29.1 Water

Water is used for cooling purposes because the end-product should not be warmer than 100 °C. Steam, from demineralised water, is necessary to heat the autoclaves and/or reactors. Water is also used for cleaning the installation. The water consumption is between 0.8 and 2 m³ of drinking water and/or demineralised water per tonne of product. This depends on the type of cooling system. Cooling water consumption is between 2 and 5 m³/t of product [109, CIAA-FEDIOL, 2002]. The cleaning water from these operations can contain traces of nickel that can accumulate in, and thus contaminate, the sludge of a WWTP. The waste water produced contains soluble organic material, SS and FOG.

3.2.29.2 Air emissions

Hydrogen emissions, e.g. in the case of installation breakdown, have an associated explosion/fire risk.

3.2.29.3 Solid output

The solid output contains the spent nickel and specialised companies can recycle this.

3.2.29.4 Energy

Energy is supplied as steam and electricity. Total energy consumption is between 110 to 280 kWh/t product (400 and 1000 MJ/t).

3.2.29.5 Noise

Noise issues may arise from cooling towers, compressors or vacuum systems.

3.2.30 Sulphitation (D.10)

3.2.30.1 Air emissions

A substance of environmental concern is SO₂, however, it is readily absorbed by the liquid to be treated, e.g. wine, and actual residual emissions are extremely low.

3.2.31 Carbonatation (D.11)

3.2.31.1 Air emissions

Excess CO₂ is vented to the air. If a limekiln is used, then there is CO emitted due to the inevitable incomplete combustion within the kiln. SO₂ and NO_x combustion products also occur and are vented to the air accompanied by small amounts of dust. Lime hydrators, used in conjunction with kilns, will also emit small quantities of dust. There is usually an over-pressure vent on the kiln. The normal kiln exhaust gases are washed before being introduced in the process. Exhaust gases and vapours from the carbonatation vessels contain NH₃, CO and other malodorous compounds.

3.2.31.2 Solid output

Any precipitate formed during the carbonatation is separated out from the sugar juice and is sometimes sent for landspreading. Residues from lime production and hydrating are sent to landfill or, e.g. used for road paving or road foundations.

3.2.31.3 Noise

If a limekiln is used, then the charging of limestone and coke may produce noise off site.

3.2.32 Carbonation (D.12)

3.2.32.1 Air emissions

There is risk of accidental releases of CO₂.

3.2.32.2 Energy

Energy is required to operate heat-exchangers and coolers.

3.2.33 Coating/spraying/enrobing/agglomeration/encapsulation (D.13)

3.2.33.1 Water

Waste water is produced from the cleaning of the equipment. This will contain product residues consisting of dissolved organic material, SS and FOG.

3.2.33.2 Air emissions

Odour is produced.

3.2.33.3 Solid output

Solid output is produced which contains organic and inorganic material.

3.2.34 Ageing (D.14)**3.2.34.1 Water**

Water is used for cleaning and this generates waste water which contains soluble organic material and SS.

3.2.34.2 Air emissions

Emissions to air include odour and VOCs.

3.2.34.3 Solid output

Solid output is produced which contains organic material. Waste from packaging may also be produced.

3.2.35 Melting (E.1)**3.2.35.1 Water**

Waste water is generated during cleaning. This waste water generally has a high BOD level and may contain SS and FOG.

3.2.35.2 Air emissions

Odour emissions may occur in the dry melting process of meat residues, for example.

3.2.35.3 Solid output

In some melting processes, a solid phase remains. This is considered to be a by-product.

3.2.35.4 Energy

In the melting process, the use of steam is the main energy component.

3.2.36 Blanching (E.2)**3.2.36.1 Water**

The leaching of sugars, starches and other soluble organic compounds from the raw fruit or vegetables into the blanching water results in high BOD, SS and dissolved solids levels. As blanching water is normally re-used/recycled, the volume of waste water from blanching is normally relatively small. However, this tends to concentrate pollutants in the waste water.

3.2.36.2 Air emissions

Steam/water vapour may be discharged to the air. Depending on the raw material being blanched, the exhaust air may contain low levels of VOCs, which may generate a low level of odour.

3.2.36.3 Solid output

Some solid organic material may accumulate in the bottom of the blanchers. This needs to be removed periodically.

3.2.36.4 Energy

Energy is used for heating the blanching water.

3.2.37 Cooking and boiling (E.3)

3.2.37.1 Water

Waste water is generated during processing and cleaning and contains product residues. The waste water produced also contains dissolved organic material, SS, FOG, dissolved solids and possibly nitrate, nitrite, ammonia and phosphate.

3.2.37.2 Air emissions

Emissions to air include odour and VOCs.

3.2.37.3 Solid output

Solid output containing organic material and FOG may result from the cleaning of cooking equipment.

3.2.37.4 Energy

Cooking and boiling uses energy to provide heat, e.g. for steam production.

3.2.38 Baking (E.4)

3.2.38.1 Water

Waste water is produced which contains soluble organic material, SS and FOG.

3.2.38.2 Air emissions

During baking, VOCs, odour and CO₂ are emitted to the air together with water vapour. An example bakery with a production capacity of 340 tonnes per day has an air emission from the ovens containing ethanol, at a concentration of approximately 1 g/Nm³. The proposed UK environmental benchmark for the annual average release of ethanol is 0.0192 g/Nm³ and the hourly mean benchmark is 0.576 g/Nm³ [102, UK, 2002].

3.2.38.3 Solid output

Solid output is produced which contains organic material. Some residues may result from dry cleaning.

3.2.38.4 Energy

Ovens are heated using either electrical energy or fuel in the form of natural gas or oil. For infrared ovens, special types of burners are applied. The energy usage for baking normally ranges from 0.125 – 0.167 kWh/kg of product (450 – 600 kJ/kg).

3.2.39 Roasting (E.5)

3.2.39.1 Water

Small amounts of water are used for quenching, e.g. roasted coffee, cereals and chicory. This water is partly evaporated and emitted into the air and partly absorbed by the product, e.g. coffee.

3.2.39.2 Air emissions

The outlet of both the roaster and the cooler contain odour components, CO₂, NO₂ and VOCs. The concentration of VOCs causing this odour is higher for the roaster outlet than for the cooler outlet. VOC levels are higher when the product is roasted to a higher degree, e.g. when the product temperature at the end of the roasting process is higher. The difference in emissions between a low roasted and a very high, i.e. very dark, roasted product can be as much as a factor 10. For batch roasters, the highest concentrations are emitted just before the end of the roasting process. In continuous roasters, the emissions are also continuous. The absolute level of VOCs depends on the product temperature at the end of the roasting; the amount of air used for roasting, which has a diluting effect; the product itself and the roasting time. The emissions of organic substances and the organic roasting losses result from the decomposition or chemical reaction of, e.g. chlorogenic acid, citric acid, oxalic acid, crude proteins and trigonellin. Nitrogen-based compounds, e.g. amines and sulphur-based compounds, e.g. mercaptans contribute considerably to the odours emitted by coffee roasting installations. In the raw gas, odorant contents of up to 300000 OU/Nm³ have been measured. TOC mass concentrations of up to 10000 mg/Nm³ are produced. Ammonia, nitrogen oxides, carbon dioxide and carbon monoxide are also produced. Dust emissions may also be a problem.

3.2.39.3 Solid output

Solid outputs include, e.g. the skins of coffee beans. For coffee, the solid output can be between 0.1 to 1.5 % of the amount of green coffee.

3.2.39.4 Energy

The actual energy consumption depends on the type of roaster being used and also on the layout of the flue-gas system.

3.2.40 Frying (E.6)

3.2.40.1 Water

Waste water arises from the cleaning of equipment and contains FOG, in the form of free fat and emulsified fat as well as other product residues. The waste water also contains SS, dissolved organic material and acid/alkali solutions.

3.2.40.2 Air emissions

The air above a fryer is extracted to prevent emissions into the working environment. This exhaust air may contain VOCs, such as the breakdown products of the edible oil. Odour may also be an issue associated with the exhaust.

3.2.40.3 Solid output

Oil which has reached the end of its useful life needs to be disposed of. Inorganic material may also be contained in the solid output.

3.2.40.4 Energy

The frying oven is usually oil-fired or steam heated.

3.2.41 Tempering (E.7)

3.2.41.1 Water

Water is used for the recirculating chilled water system for cooling. The waste water produced contains soluble organic material and SS.

3.2.41.2 Energy

Electricity is needed for the pumps and drives and for the cooling system.

3.2.42 Pasteurisation, sterilisation and UHT (E.8)

3.2.42.1 Water

Water or other chilling media are required for cooling after heat treatment. Cooling after UHT treatment can be performed in two steps, i.e. firstly, by flash cooling to atmospheric pressure in flash vessels, followed by cooling with water.

In the case of aseptic or hot filling, there are product losses of both organic and inorganic deposits from the heat transfer surface. These are later discharged in the waste water during the cleaning of the equipment. In the case of heat treatment after canning or bottling, chlorinated cold water is required. This results in waste water containing dissolved organic material and SS.

3.2.42.2 Energy

Energy, usually in the form of steam or hot water, is required for heat treatment. After heat treatment, energy can be recovered by heat-exchange in a recovery section. For the final cooling, a cooling medium is needed. Cooling can be accomplished by once-through cooling whereby the cooling water is cooled down in a cooling tower or with a recirculating chilled water system. The latter uses a mechanical refrigeration system, so energy is consumed.

3.2.43 Evaporation (liquid to liquid) (F.1)

3.2.43.1 Water

The removal of deposits during cleaning and product losses during start-ups and shut-downs contributes to the organic and inorganic load in the waste water. During evaporation, condensates from the product are also produced. Depending on their content, e.g. organic, inorganic and SS, these condensates can be re-used in the process or are treated in a WWTP. The final vapours are condensed in an open or closed condenser using cooling water. The waste water contains dissolved organic and inorganic matter and SS.

3.2.43.2 Air emissions

Sometimes non-condensable gases are vented to the air to ensure efficient heat transfer. The environmental effects arising depend on the gases being vented. Dust and odour may also be a problem.

3.2.43.3 Energy

Steam requirements for single-stage evaporators range from 1.1 to 1.2 tonnes of steam per tonne of evaporated water. Energy requirements may be reduced when using multi-effect evaporators. In the case of double or third effect, the steam requirement lowers respectively to 0.6 - 0.7 and 0.4 tonnes of steam per tonne of evaporated water. The steam consumption can also be reduced by applying mechanical or thermal vapour recompression (see Sections 4.2.9.2.1 and 4.2.9.2.2) Sometimes exhaust gases can be used to recover energy from other processes such as drying (see Section 3.2.44).

3.2.43.4 Noise

Noise is often produced from the evaporation processes, in particular from the thermal compressor, the mechanical compressor, the steam ejectors and the high velocity of the fluids in the pipework. This can usually be managed by applying appropriate acoustic insulation. Noise is also generated in pumps due to cavitation.

3.2.44 Drying (liquid to solid) (F.2)

3.2.44.1 Water

The use of water is normally restricted to cleaning the equipment. The amount used greatly depends on the type of equipment. During cleaning, waste water is generated containing soluble organic material and SS. When air scrubbers are used, a waste water stream containing organic material such as fine dust is generated.

3.2.44.2 Air emissions

In hot air drying, a gas/vapour is generated and exhausted into the air. This gas/vapour may contain dust and VOCs, which originate from the product. This may cause an odour problem which might require treatment prior to discharge. If drying is done using direct gas or fuel fired burners, the exhaust gases might contain CO₂, CO, SO₂, NO_x, depending on the heat source and burner type. Food safety requirements must be respected, especially when drying very sensitive products.

3.2.44.3 Solid output

A solid output may be generated when the equipment is emptied for a next batch or for cleaning. This solid output can consist of raw materials, product residues, and dust which has been recovered from the exhaust air. These solid products/dust can be recycled back into the process or sold as animal feed.

3.2.44.4 Energy

For the evaporation of water, theoretically 0.611 kWh/kg (2.2 MJ/kg) energy is required. In practice, due to energy losses in the process, the energy consumption for water evaporation ranges from 0.694 – 0.972 kWh/kg (2.5 to 3.5 MJ/kg).

3.2.44.5 Noise

Noise may arise from the air inlet and outlet of the driers. If sound baffles are used to reduce the noise at outlets, these baffles need to be checked periodically to remain effective.

3.2.45 Dehydration (solid to solid) (F.3)

3.2.45.1 Water

Water may be used in cleaning the equipment, with the resultant waste water containing dissolved organic material and SS. Kilns for the drying of malt are cleaned dry.

3.2.45.2 Air emissions

In the hot-air dehydration process, air, with water vapour containing VOCs and dust, is released. If dehydration is done using direct-fired burners, the exhaust gases might also contain CO₂, CO, SO₂, and NO_x, depending on the heat source and burner type. Depending on the type of raw material or product, the dust may be glutinous and wet, e.g. meal from oilseed processing. Dry dust can be filtered and wet dust can be recovered using cyclones. Odour may also be a problem.

3.2.45.3 Solid output

Solid organic material may be generated when equipment is emptied for a next batch or for cleaning. These outputs can consist of raw material, product residues and dust. These solid products/dust can be recycled back into the process or sold as animal feed.

3.2.45.4 Energy

For the evaporation of water, theoretically 0.611 kWh/kg (2.2 MJ/kg) energy is required. However, in practice, this very much depends on the type of drier used and can range from 0.556 – 1.08 kWh/kg (2.0 – 3.9 MJ/kg). Steam driers can have a considerably lower energy consumption if they consist of more effects (multiple effect evaporation). Sometimes exhaust gases from a combustion (CHP) plant are used to dry products, thereby reducing the direct energy consumption. The energy consumption for dehydration can be further reduced by increasing the dry substance content of the wet product. This can be achieved by pre-evaporation or by using special dewatering equipment.

3.2.45.5 Noise

Noise may arise from the air inlet and outlet of the driers.

3.2.46 Cooling, chilling and cold stabilisation (G.1)

3.2.46.1 Water

Water may be used as the cooling medium in a once-through system. When cooling water is recirculated, closed-circuit cooling towers can be used for heat removal.

3.2.46.2 Air emissions

In cryogenic cooling, emissions of gaseous N₂ or CO₂ occur. Leaking refrigeration equipment can lead to emissions of refrigerant.

3.2.46.3 Energy

Electrical energy is needed to drive the pumps circulating the cooling water or the fans in air cooling. Mechanical refrigeration systems generally require 0.3 – 1.0 kWh power per cooling effect. However, overall, their energy consumption is significantly less than the total energy required for the manufacture and use of liquid N₂ or CO₂.

3.2.46.4 Noise

Noise issues may occur from fans and cooling towers.

3.2.47 Freezing (G.2)

3.2.47.1 Water

Waste water, sometimes containing used brines may result from immersion freezing.

3.2.47.2 Air emissions

In cryogenic freezing, emissions of gaseous N₂ or CO₂ are produced.

3.2.47.3 Energy

Energy consumption is the major environmental issue. Electrical energy is needed for the fans for air circulation and the freezing system. For example, deep freezing is the most energy consuming step in the manufacture of deep frozen vegetables consuming 80 – 280 kWh_e/t of frozen vegetable. Energy amounting to about 0.003 kWh/m² (0.01 MJ/m²) floor surface of tunnel/hour of operation is also consumed in the form of hot water. The energy consumption of a freezing tunnel depends on various factors and the following list uses the deep freezing of fruit and vegetables to illustrate these [32, Van Bael J., 1998]. Energy consumption depends on, e.g:

- the type of food to be frozen, e.g. voluminous vegetables, such as cauliflower florets are more difficult to freeze than small vegetables such as peas or diced carrots
- the temperature of the food at the entrance to the freezing tunnel. The higher this temperature is, the more heat has to be removed from the food before it is frozen
- the mass flowrate of the food. The higher the flowrate, the higher the quantity of energy that needs to be removed, and the greater the demand for cold air in the tunnel
- the residence time, which also determines the demand for cold air in the freezing tunnel. The longer the residence time, the more chance the food has to freeze. The thickness of the layer of food is directly proportional to the required residence time
- the energy consumption which is determined by the airflow rates in the freezing tunnel. The higher the airflow rates, the better the heat-exchange between the evaporators and the air on one hand, and the air and the food on the other hand. Higher airflow rates lead to higher energy consumption by the fans and higher cooling loads for the freezing tunnel; the full output of the motors needs to be cooled
- the efficiency or the COP, which plays a role in the energy consumption of freezing tunnels. As explained earlier, the efficiency is mainly determined by the condensation and evaporator temperature.

The energy consumption per unit of weight of frozen product depends very much on the parameters set for the evaporator temperature, fan rating and product flowrate, and the condensation pressures and type of product being processed. Since many factors affect the specific energy consumption, it is, therefore, only possible to give broad ranges for consumption [32, Van Bael J., 1998].

3.2.47.4 Noise

Noise issues may occur from the operation of fans.

3.2.48 Freeze-drying/lyophilisation (G.3)

3.2.48.1 Water

The condensed water derived from the dried product is disposed of as waste water. The concentration depends on the original water content of the material and on the type of material that is being dried. The waste water contains dissolved organic material and SS.

3.2.48.2 Energy

For freeze-drying, mainly electrical energy is used.

3.2.49 Packing and filling (H.1)

3.2.49.1 Water

Releases occur due to product spills. Waste water is generated, e.g. by cleaning glass containers and kegs. If returned refillable bottles are used, the waste water will also contain residual contents. Installation and equipment cleaning also produces waste water, which typically contains dissolved organic material and SS.

3.2.49.2 Air emissions

Dust emissions may be a problem.

3.2.49.3 Solid output

Solid waste includes cast-offs due to, e.g. packaging machine faults/inefficiencies during filling, and capping process waste, especially during machine start-ups and shut-downs. Processes such as glass bottle blowing are usually completed off site by suppliers but waste can result from breakages *in situ*. Bottle blowing of PET may be carried out on site using either PET pellets or supplied pre-forms. This produces waste from off-cuts. Aluminium or steel can cylinders and aluminium can ends are pre-manufactured, off site. Laminated cartons and pouches are formed on site. This results in waste from off-cuts. Small amounts of solid waste are produced from inks and from the cleaning of printing equipment. The lubrication of equipment and the transport systems also produce waste. Some packaging is recycled.

3.2.49.4 Energy

Energy is consumed by filling/capping/packing equipment and other associated activities.

3.2.49.5 Noise

Noise emissions may be a problem along bottle filling lines.

3.2.50 Gas flushing and storage under gas (H.2)

3.2.50.1 Air emissions

Gas mixtures used in the above processes are all supplied to the packing installation either in premixed form or as individual gases that are mixed *in situ*. Gas emissions, e.g. CO₂, may occur during the process or as a result of accidents.

3.2.51 Cleaning and disinfection (U.1)

3.2.51.1 Water

Large quantities of water are required for cleaning and disinfection. In many installations, this is the main consumer of water, with the amount depending on the type and size of equipment to be cleaned and the materials processed. Cleaning and disinfection produces waste water. This typically contains soluble organic material, FOG, SS, nitrate, nitrite, ammonia and phosphate from product remnants and removed deposited soil. It also contains residues of cleaning agents, e.g. acid or alkali solutions. In principle, the cleaning and disinfection agents that are used are discharged via the waste water, either in their original state or as reaction products.

3.2.51.2 Solid output

Product residues may be recovered during cleaning.

3.2.51.3 Energy

Cleaning is commonly carried out at elevated temperatures, which, therefore, requires the use of energy to heat water and produce steam.

3.2.52 Energy generation and consumption (U.2)

3.2.52.1 Water

Boiler treatment chemicals, silica and other soluble minerals are concentrated within boilers. They are removed by blowing down the boiler at a rate of 1 % to more than 10 % of the steam production rate. The blowdown water is discharged and treated either in an on-site or off-site WWTP. Blowdown needs to take place to maintain the efficient, and ultimately safe, operation of the boiler.

3.2.52.2 Air emissions

The main products resulting from the combustion process are CO₂ and water vapour. CO₂ emissions from coal firing are almost twice as those from natural gas. The contaminants generated and emitted depend on the fuel type, combustion process and combustion plant design. These are SO₂, CO, NO_x and dust.

Emissions of SO₂ are a result of the sulphur content of the fuel. Gas has only trace amounts of sulphur. Gasoil has up to 0.1 % by weight of sulphur. Coal has between 0.5 % and 2.5 % by weight of sulphur. Fuel oil may have up to 3.5 % by weight of sulphur.

Emissions of NO_x depend, not only on the fuel, but also on the inherent design of the combustion unit and the flame temperature. Gas, generally, does not contain any significant amounts of nitrogen compounds but will produce NO_x from the oxidation of the nitrogen in the combustion air. Therefore, NO_x from gas combustion is the lowest of any fossil fuel. NO_x emissions may be reduced by steam injection into the burning chamber of the gas turbine or by using low NO_x burners.

When the product is heated by direct contact with combustion gases, VOCs and odours are released with the process air. The heat released at a chimney depends on the fuel type and plant design. The consumption of purchased electricity does not cause emissions at FDM installations as the emissions take place at the power station. Information about emissions at large combustion plants, i.e. those with a rated thermal input exceeding 50 MW, is available in the "Large combustion plants BREF" [220, EC, 2003].

3.2.52.3 Solid output

Ashes from solid fuel fired boilers and scale and inert soot deposits which are removed during periodic boiler maintenance and cleaning, are produced. They are sent for landfill.

3.2.52.4 Noise

Normal boiler operations do not give rise to noise outside the installation, but this depends on the measures taken to contain the noise and the proximity of neighbouring premises. During process interruptions, and during periods of testing and commissioning, there may be short periods when the boiler safety relief valve operates. This effect is likely to be local to the installation but could be a source of nuisance during that period. Large relief valves can be provided with silencers.

3.2.53 Water use (U.3)

3.2.53.1 Water

Waste water from water regeneration and residues from other processes are discharged to water. Minimisation of water consumption by process optimisation and water recycling can be applied.

3.2.53.2 Solid output

Mineral sludges and spent resins from water treatment processes need to be disposed of.

3.2.54 Vacuum generation (U.4)

3.2.54.1 Water

Water is used in water-ring type vacuum pumps for cooling and for sealing. To reduce water consumption, the water is normally recirculated in closed-circuit systems with a bleed off determined by the condensable matter. Waste water is produced which contains soluble organic material.

If steam jet ejectors are used for vacuum production, not only the media coming from the evacuated plant has to be condensed, but also the driving steam of the jet ejector. This is normally done in spray condensers. Here, water is used to condense the steam along with any volatiles carried over. For large installations, the volume of water used to condense the steam can be significant, i.e. during refining of sugar or edible oil. The volatile material carried over is condensed in the water thereby increasing the level of dissolved organic material. To reduce water consumption, water can be recirculated over cooling towers. In this case a bleed from the system is required for the condensed steam. This can lead to a concentration of the organic material condensed in the water. With indirect condensers or heat-exchangers, the volume of condensate is equivalent to the condensed live steam and other condensable matter, and will contain any organic volatiles carried over. With chilling or freezing systems, the volume of condensate is reduced further.

3.2.54.2 Air emissions

Depending on the material being processed, air evacuated by vacuum pumps may contain volatile material, which, if not properly controlled, may result in odour problems.

Non-condensable material may be discharged into the air with steam jet ejectors. Depending on the material being processed, this discharge may result in odour emissions. If condenser water is recirculated over cooling towers, the drift/mist from the towers may result in odour emissions. Indirect recirculation with heat-exchangers with two cycles may be used in this case. Heat-exchangers have to be cleaned regularly.

3.2.54.3 Energy

The energy usage will depend on the type of compressor used, the absolute pressure to be achieved and the size of the system. For large operations, the consumption can be reasonably high.

3.2.54.4 Noise

Noise may occur due to the operation of the fans associated with the cooling towers.

3.2.55 Refrigeration (U.5)

3.2.55.1 Water

Water consumption can be significant when water is used as the cooling medium for the condenser in a once-through system. Recirculating the cooling water over a cooling tower reduces water consumption. Accidental release of liquid ammonia needs to be prevented.

3.2.55.2 Air emissions

Refrigeration equipment which contains mainly NH₃ or (H)CFCs does not emit refrigerants, if properly operated and maintained, as the systems are closed. An accidental breakage or leakage could cause releases into the atmosphere, so the risk of an accident needs to be minimised.

3.2.55.3 Energy

Refrigeration equipment needs a high electricity input.

3.2.55.4 Noise

Noise produced by the compressors of refrigeration equipment may be a problem.

3.2.56 Compressed air generation (U.6)

3.2.56.1 Air emissions

Air emissions are generally minimised due to the use of filters to remove oil and other impurities to ensure that the compressed air is of food grade quality.

3.2.56.2 Energy

Energy is consumed in the compressor.

3.2.56.3 Noise

Noise emissions can be a problem.

3.3 Consumption and emission levels in some individual FDM sectors

Unit operations in specific sectors are described in Section 2.2.

Table 3.9 shows a summary of reported water consumption and waste water volumes for some of the FDM sectors. Some of the consumption and emission values are inconsistent.

Sector	Water consumption	Waste water volume	Unit	Source
Meat and poultry	2 – 20 m ³ /t	10 – 25 m ³ /t	**	[41, Nordic Council of Ministers, 2001, 89, Italian contribution, 2001]
Fish				
Herring filleting	3.3 – 10 m ³ /t	2 – 40 m ³ /t	**	[27, ATV, 2000, 28, Nordic Council of Ministers, 1997]
Mackerel	20 – 32 m ³ /t			
White fish	4.8 – 9.8 m ³ /t			
Shrimp processing	23 – 32 m ³ /t			
Fruit and vegetable¹				
Canned fruit	2.5 – 4.0 m ³ /t	11 – 23 m ³ /t	*	[5, Derden A Vercaemst P and Dijkmans R, 1999, 74, Greek Ministry for the Environment, 2001, 134, AWARENET, 2002, 140, World Bank (IBRD), et al., 1998]
Fruit juices	6.5 m ³ /t			
Canned vegetables	3.5 – 6.0 m ³ /t			
Frozen vegetables	5.0 – 8.5 m ³ /t			
Deep frozen vegetables	2.5 – 5.0 m ³ /t			
Preserved vegetables	5.9 – 11 m ³ /t			
Potato	2.4 – 9.0 m ³ /t			
Jams	6 m ³ /t			
Baby food	6.0 – 9.0 m ³ /t			
Starch				
Maize	1.7 – 3 m ³ /t	1.4 m ³ /t	**	[115, CIAA-AAC-UFE, 2002, 152, Austria, 2002]
Wheat	1.7 – 2.5 m ³ /t	1.8 m ³ /t		
Potato	0.7 – 1.5 m ³ /t	2 m ³ /t		
Dairy²		1 – 5 l/kg	**	[152, Austria, 2002]
Milk and yoghurt	0.6 – 4.1 l/l			[42, Nordic Council of Ministers, et al., 2001]
Cheese	1.2 – 3.8 l/l			
Milk powder, cheese and/or liquid products	0.69 – 6.3 l/l			
Milk and yoghurt	0.8 – 25 m ³ /t	0.9 – 25 m ³ /t		[160, European Dairy Association, 2002]
Cheese	1 – 60 m ³ /t	0.7 – 60 m ³ /t		
Milk powder, cheese and/or liquid products	1.2 – 60 m ³ /t	0.4 – 60 m ³ /t		
Beer	0.32 – 1 m ³ /hl	0.24 – 0.9 m ³ /hl	*	[69, Environment Agency of England and Wales, 2001, 199, Finland, 2003]
Sugar beet	0.23 ³ – 1.5 m ³ /t		**	[139, Nielsen E.H. Lehmann, 2002, 152, Austria, 2002]

Sector	Water consumption	Waste water volume	Unit	Source
Vegetable oil				

Crude oil production	0.2 – 14 m ³ /t	0.2 – 14 m ³ /t	**	[65, Germany, 2002, 74, Greek Ministry for the Environment, 2001, 109, CIAA-FEDIOL, 2002, 134, AWARENET, 2002, 140, World Bank (IBRD), et al., 1998, 182, Germany, 2003, 185, CIAA-FEDIOL, 2004]	
Chemical neutralisation	1 – 1.5 m ³ /t	1 – 1.5 m ³ /t	*		
Deodorisation	10 – 30 m ³ /t	10 – 30 m ³ /t			
Hardening	2.2 – 7 m ³ /t				
Chemical refining	0.25 – 0.8 m ³ /t	14 – 35 m ³ /t			
Olive oil production	5 m ³ /t				[142, IMPEL, 2002]
Traditional extraction		2 – 5 m ³ /t			[74, Greek Ministry for the Environment, 2001, 86, Junta de Andalucia and Agencia de Medio Ambiente, 1994]
Three-phase extraction		6 – 8 m ³ /t			
Two-phase extraction		0.33 – 0.35 m ³ /t			
Soft and alcoholic drinks	6 – 14 m ³ /m ³	0.8 – 3.6 m ³ /m ³			*
¹⁾ Not applicable for tomato processing					
²⁾ Not applicable for ice-cream processing					
³⁾ Excluding cooling water					
*Per unit of product					
**Per unit of raw material					
This table summarises the data reported in Section 3.3. Some water consumption and waste water volumes are inconsistent. Information on applied processes and techniques, operating conditions and sampling methods not provided.					

Table 3.9: Summary of water consumption and waste water volumes in the FDM sector

3.3.1 Meat and poultry

3.3.1.1 General information

3.3.1.1.1 Water

The main environmental impact of meat and poultry manufacturing is the production of waste water. Significant quantities of water are used for washing and thawing meat. The reported water consumption is about 3 – 5 m³/t. The water used for thawing can be recirculated in a closed-circuit and used again [182, Germany, 2003]. Some other major water consuming steps are, e.g. pasteurising, sterilising, cooling, cleaning and disinfection. Stringent hygiene measures are applied to the cutting and chilling of carcasses which lead to relatively large quantities of waste water arising from equipment and installation cleaning.

3.3.1.1.2 Air emissions

Air pollution is produced mainly due to the operation of boilers and smokers. Odour may be a nuisance. Refrigerants may leak causing air pollution.

3.3.1.1.3 Solid output

Cutting and deboning meat and poultry produces bones, fat and skin. The use of animal by-products is regulated by Regulation 1774/2002/EC [188, EC, 2002]. Bones and fat may be used for, e.g. producing glue and detergents, or for producing gelatine which can be used, e.g. in some cases in the food or pharmaceutical industries. Some animal by-products must be disposed of as waste. Solid output may also be produced in packing operations such as waste packaging. Table 3.10 shows the proportion of carcasses considered to be by-products.

	By-products in cutting/deboning (% of carcass weight)		
	Beef	Pig	Poultry
Bones	12	5 – 9.5	1 – 2
Fat		3 – 6	6
Skin			1 – 2

Table 3.10: By-products in cutting and deboning meat
[134, AWARENET, 2002]

3.3.1.1.4 Energy

A considerable amount of thermal energy is used in processes involving heat treatments such as boiling, cooking, pasteurising, sterilising drying and smoking. Other large energy consuming operations are chilling, freezing, thawing, and cleaning and disinfection.

3.3.1.2 Meat and poultry production

3.3.1.2.1 General information

This category covers a wide range of products and processing techniques, which are not practicable to consider individually.

All lines, equipment and process areas that are not in designated dry areas require wet cleaning, which generates waste water contaminated with the product, raw materials and cleaning chemicals. If scraps are washed down the drain, this will increase the COD, fat and SS content of the waste water. Cooking methods that involve direct contact between water or steam and product, produce waste water, as do cooling, chilling, freezing and filling operations.

Ingredients added to the meat may enter the waste water stream as a result of equipment washouts and spillage. Those used in large quantities, e.g. batter, breadcrumbs and cooking oil, can make a significant contribution to the BOD, TSS and FOG levels of the waste water.

It is reported that in the UK, fresh meats, especially poorer quality beef, are often treated with enzymes of plant or fungal origin to improve tenderness. The meat is either dipped in or sprayed with enzymes in solution. Enzymes are complex organic structures and unless operators ensure that the discharge of the enzyme solutions is kept to a minimum, they will carry a BOD contribution and may potentially affect the biology of a WWTP [13, Environment Agency of England and Wales, 2000]. Italy reports that the technique is not used there [184, Italy, 2003].

Table 3.11 summarises reported consumption and emission levels expressed per tonne of finished product in the Italian meat industry for cooked ham manufacturing. A flow sheet for cooked ham and shoulder production is given in Figure 2.4.

Cooked ham						
Unit operation		Water consumption	Waste water load	Solid output	Electrical energy	Thermal energy
No.	Description	(m ³ /t)	(kg COD/t)	(kg/t)	(kWh/t)	(kg steam/t)
A.1	Materials handling and storage			** (plastic, cardboard)	*	
A.2	Sorting/screening, grading, dehulling, destemming/destalking and trimming			*(meat)	*	
A.4 A.5	Washing and thawing	0 – 15	**	** (fat)	*	**
B.1	Cutting, slicing, chopping, mincing, pulping and pressing			** (meat)	**	
B.2	Mixing/blending, homogenisation and conching			*(meat)	*	
B.4	Forming/moulding and extruding			*(meat)	*	
D.7	Brining/curing and pickling	0.5	*	** (salt)	*	
D.8	Smoking			*(ash)		**
D.13	Coating/spraying/enrobing/agglomeration/encapsulation			*(dust)		
E.3	Cooking and boiling	2.5	***		*	**
E.5	Roasting			*(dust)		**
E.6	Frying					**
E.7	Tempering					
E.8	Pasteurisation, sterilisation and UHT	*			*	**
F.3	Dehydration (solid to solid)			*(dust)	*	***
H.1	Packing and filling			*(plastic)	**	
U.1	Cleaning and disinfection	**	**		*	*
U.2	Energy generation and consumption	0.25	*		**	
U.3	Water use			*(resins)	*	
U.4	Vacuum generation	*			*	
U.5	Refrigeration		**		**	
	Overall totals of typical installations (all unit operations are not undertaken at each installation, so the totals are not the sum of the levels for each unit operation)	4 – 18¹	10 – 21			

¹⁾ The higher value is valid for thawing with water
 *low consumption/emission
 **medium consumption/emission
 ***high consumption/emission

Table 3.11: Consumption and emission levels for cooked ham manufacturing in Italy [89, Italian contribution, 2001]

3.3.1.2.2 Salami and sausage production

The main environmental factors relating to sausage manufacture concern the smoking and cooling processes. Wood smoke contains many compounds, which are of concern from a health point of view. They are, e.g. PAH, phenols, nitrite and N-nitroso compounds plus CO. Effective ventilation and exhaust is, therefore, necessary for kilns and rooms.

The smoke can produce odour problems in the surroundings. The odour strength in the emissions from a smoking kiln depends on the smoking process and the ventilation and drying conditions. Typical odour strength in untreated air is 5000 – 20000 OU/m³. A wet scrubber for cleaning the emissions from a smoking kiln will typically have an efficiency of 50 – 70 %, measured in OU/m³.

A carbon content of 1000 ppm has been measured in the exhaust from a modern warm smoking and cooking unit. After thermal oxidation at 815 °C and cooling to 26 °C, 5 ppm carbon was measured.

In a Norwegian investigation, the following levels for pollution from smoking were given per tonne of product: 0.3 kg CO, 0.15 kg inorganic particles, and 0.2 kg TOC. Furthermore, when examining a cooking/smoking cabinet, the following emissions were found after thermal oxidation of the smoke gases: 7 mg TOC/m³ or 0.2 mg TOC/t of sausages. The gas did not contain CO.

Soot and tar compounds are deposited in the kilns and on smoking sticks and frames. This must be removed and this is often carried out with powerful alkaline detergents. Waste water from the smoking department can, therefore, contain a large number of chemical compounds.

Only very limited information is available about the use of resources and pollution from the manufacturing of salami and Vienna sausages. One reason is that a meat processing installation or a slaughterhouse may have many other activities than those mentioned here and that the companies do not have sufficient separation of the figures for consumption or emission levels for each product line. Table 3.12 shows reported specific consumption of water and energy, and emissions of waste water in salami and sausage production.

Product	Unit*	Salami	Salami	Various	Various sausages
Country		DK	DK	SE	NO
Water	m ³ /t	7.5	5.3	7.7	10
Electricity	kWh/t	unknown	1000	750	1300
Heat	kWh/t	1240	900	1000	450
Recuperation	kWh/t	unknown	230	250	unknown
Total energy	kWh/t	unknown	2130	2000	1750
BOD	kg/t		4.7	15	8 – 10
N	g/t		300		
P	g/t		140		

* t refers to tonnes of finished product

Table 3.12: Specific consumption of water and energy and emissions of waste water in salami and sausage production
[41, Nordic Council of Ministers, 2001]

Table 3.13 summarises consumption and emission levels expressed per tonne of finished product reported for the Italian meat industry for preserved meat products manufacturing.

Preserved products, e.g. sausages, dressed pork, ham, bacon, etc						
Unit operation		Water consumption	Waste water load	Solid output	Electrical energy	Thermal energy
No.	Description	(m ³ /t)	(kg COD/t)	(kg/t)	(kWh/t)	(kg steam/t)
A.1	Materials handling and storage			** (plastic, cardboard)	*	
A.2	Sorting/screening, grading, dehulling, destemming/destalking and trimming			*(meat)	*	
A.4 A.5	Washing and thawing	*	***	**(fat)	*	**
B.1	Cutting, slicing, chopping, mincing, pulping and pressing			**(meat)	**	
B.2	Mixing/blending, homogenisation and conching			*(meat)	*	
B.4	Forming/moulding and extruding			*(meat)	*	
D.7	Brining/curing and pickling			**(salt)	*	
D.8	Smoking					**
F.3	Dehydration (solid to solid)			*(dust)	***	***
H.1	Packing and filling			*(plastic)	**	
U.1	Cleaning and disinfection		**		*	*
U.2	Energy generation and consumption		*		**	
U.3	Water use			*(resins)	*	
U.4	Vacuum generation				*	
U.5	Refrigeration		**		**	
	Overall totals of typical installations (all unit operations are not undertaken at each installation, so the totals are not the sum of the levels for each unit operation)	10 – 20¹	20 – 25	35 – 50	2500 – 4000²	
¹⁾ The higher value is valid for thawing with water ²⁾ Thermic + electric (1300 – 1400 kWh/t + 150 – 180 m ³ methane/t) * low consumption/emission ** medium consumption/emission *** high consumption/emission						

Table 3.13: Consumption and emission levels for preserved meat products manufacturing in Italy [89, Italian contribution, 2001]

3.3.1.3 Meat and poultry preservation

3.3.1.3.1 Freezing

The only waste water generated from freezing is the overflow from the cooling system and freezer defrost water. See also Section 3.2.47.

3.3.1.3.2 Curing

Salting and curing can introduce NaCl and Na₂NO₃ into the waste water. Operators need to minimise over production of brine and also production out of specification brine. Not only would this constitute discharge of raw material, but excess/waste brine that would also have a detrimental effect on the WWTP if discharged in large quantities. Chloride brine is not reduced through a biological WWTP, apart from dilution. Traditional dry curing is practised by a number of small highly specialised companies. The process liberates small quantities of cooking waste water only.

Table 3.14 summarises consumption and emission levels expressed per tonne of finished product reported for the Italian meat industry for cured ham manufacturing. A flow sheet for cured ham production is given in Figure 2.5.

Cured ham						
Unit operation		Water consumption	Waste water load	Solid output	Electrical energy	Thermal energy
No.	Description	(m ³ /t)	(kg COD/t)	(kg/t)	(kWh/t)	(kg steam/t)
A.1	Materials handling and storage			** (plastic, cardboard)	*	
A.2	Sorting/screening, grading, dehulling, destemming/destalking and trimming			*(meat)	*	
A.4	Washing	*(** ¹)	***	** (fat)	*	**
A.5	Thawing	*(** ¹)	***	** (fat)	*	**
B.1	Cutting, slicing, chopping, mincing, pulping and pressing			** (meat)	**	
B.2	Mixing/blending, homogenisation and conching			*(meat)	*	
B.4	Forming/moulding and extruding			*(meat)	*	
D.7	Brining/curing and pickling			** (salt)	*	
D.8	Smoking (<i>Spek and Hungarian salami</i>)			*(ash)		*
F.3	Dehydration (solid to solid)	***		*(dust)	***	***
H.1	Packing and filling			*(plastic)	**	
U.1	Cleaning and disinfection	**	**		*	*
U.2	Energy generation and consumption	*	*		**	
U.3	Water use				*	
U.4	Vacuum generation				*	
U.5	Refrigeration		**	*(resins)	**	
	Overall totals of typical installations (all unit operations are not undertaken at each installation, so the totals are not the sum of the levels for each unit operation)	2 – 20¹	20 – 25	35 – 50	2500 – 4000²	

¹) The higher value is valid for thawing with water
²) Thermic + electric (1300 – 1400 kWh/t + 150 – 180 m³ methane/t)
* low consumption/emission
** medium consumption/emission
*** high consumption/emission

Table 3.14: Consumption and emission levels for cured ham manufacturing in Italy [89, Italian contribution, 2001]

3.3.1.3.3 Smoking

Smoking is most often carried out on cured meat, however, it can be used on fresh meat products that are cooked before serving. Traditional smoking techniques rely on smouldering wood or sawdust and do not generate waste water. The mass production alternative is to use liquid smoke, prepared by the destructive distillation of wood and applied by spraying, dipping or atomisation. Contaminated waste water is produced when containers or equipment that have been in contact with liquid smoke are cleaned.

During the application of smoke to the meat products, a portion of the smoking ingredients condenses on the walls of the chambers. These tar-like layers are removed with hot water by an alkaline cleaning solution. This water is highly contaminated and should be disposed of separately; it has a COD level of 20000 – 100000 mg/l, pH of 12 – 14, phenol index of 20 - 480 mg/l, and PAH level of 1 – 5 mg/l.

3.3.1.3.4 Drying

Dried meats are produced by curing, followed by drying at low humidity. Unless odour abatement considerations make it necessary to condense water vapour from the drier flue-gases, no waste water is generated.

3.3.1.3.5 Canning

The use of hot water or direct steam heating for cooking, prior to canning produces waste water contaminated with fat, protein and fragments of meat. After canning, the meats must be heat-processed to achieve pasteurisation and shelf stability. Can cleaning, both before and after filling, and can cooling use considerable quantities of water.

Table 3.15 summarises consumption and emission levels expressed per tonne of finished product reported for the Italian meat industry for canned meat manufacturing. A flow sheet for canned meat production is given in Figure 2.3.

Canned meat manufacturing						
Unit operation		Water consumption	Waste water load	Solid output	Electrical energy	Thermal energy
No.	Description	(m ³ /t)	(kg COD/t)	(kg/t)	(kWh/t)	(kg steam/t)
A.1	Materials handling and storage			18 ¹	1 – 2	
A.4 A.5	Washing and thawing	6 – 12	1 – 2		0.5 – 1.5	
B.1	Cutting, slicing, chopping, mincing, pulping and pressing					
E.8	Pasteurisation, sterilisation and UHT	1.5 – 3.5			2 – 4	800 – 900
G.1	Cooling, chilling and cold stabilisation	1.5 – 3.5				
H.1	Packing and filling		1 – 2	0.7 ²	100 – 120	
U.1	Cleaning and disinfection	0.5 – 2.0	20		5 – 10	
U.2	Energy generation and consumption	1 – 2				
U.3	Water use			1 ³		
U.4	Vacuum generation					
U.5	Refrigeration					
Overall totals of typical installations (all unit operations are not undertaken at each installation, so the totals are not the sum of the levels for each unit operation)		10 – 18	20 – 25	20 – 30	150 – 400	800 – 900
¹) Plastic, cardboard ²) Cans ³) Sludge, resins						

Table 3.15: Consumption and emission levels for canned meat in Italy [89, Italian contribution, 2001]

3.3.2 Fish and shellfish

Major environmental impacts associated with fish processing operations are the high consumption of water, consumption of energy and the discharge of a waste water with a high organic concentration due to the presence of oils, proteins and SS. Waste water can also contain high levels of phosphates, nitrates and chloride. Noise, odour and solid wastes may also be concerns for some installations. In addition to this, due to its highly perishable nature when compared to other FDM products, if not properly refrigerated, product yield decreases and product losses contribute to the solid and liquid waste loads. These solids may be used in fish-meal production.

3.3.2.1 Water consumption

To meet quality and hygiene standards, the fish sector uses high quantities of water. It is mainly consumed for cleaning operations and washing, cooling, and transportation of fish. Fish canning and fish filleting consume large quantities of water, e.g. to clean and lubricate the filleting machinery. Typical figures for fresh water consumption are for thawing, about 1 m³/t fish; for filleting 5 to 11 m³/t fish, and for canning, 15 m³/t fish. Water is used for transporting fish and viscera, for cleaning the installation and the equipment, for washing raw materials and products, and for thawing. Reported water consumption and specific COD loads for traditional fish processing are summarised in Table 3.16.

Production	Water consumption (m ³ /t raw fish)	COD (kg/t raw fish)
Herring filleting	3.3 – 10	Up to 95
Mackerel		
Cleaning and head cut	20	270
Thawing included	26 – 32	
White fish processing		
Fresh fish	4.8	5 – 36
Thawing included	9.8	
Shrimp processing	23 – 32	100 – 130

Table 3.16: Specific water consumption and organic load in Nordic countries [28, Nordic Council of Ministers, 1997]

3.3.2.2 Waste water

Most of the water consumed during fish processing becomes waste water. The process related waste water is produced in different processing steps, e.g. thawing, washing, head cutting, filleting, skinning and trimming, and in cleaning the equipment and the installation.

When frozen fish is used as a raw material, a thawing step is needed. The organic pollution of the waste water is relatively small. Scaling normally takes place in rotating perforated drums. Scales are flushed away using large amounts of water – 10 to 15 m³/t fish. Large volumes of waste water and organic pollution are generated. If the fillets are to be skinned, scaling is not necessary. In automated filleting and eviscerating processes, water is used to lubricate fish while passing through the machine. For some species such as mackerel, a warm caustic bath is necessary to remove the skin and the waste water needs to be neutralised before it is discharged.

Water is used for washing and rinsing the fish, giving rise to waste water carrying fish scraps and viscera. Viscera from oily fish contain high levels of oil and soluble matter, thus waste waters from their filleting normally have higher COD levels (3000 – 60000 mg/l) than those from white fish filleting (2000 – 6000 mg/l). The highly polluted waste water is generated due to the time that solid wastes are in contact with the water which contains blood and fat. In automated skinning, the fillet is pulled over a freezing drum. Water is used to clean and lubricate the machine. The skinning of fatty fish releases large quantities of oil to the waste water. The skinning process contributes about one third of the overall organic pollution in the waste water of filleting installations.

As the evisceration of fatty fish takes place at the processing installation, and white fish are eviscerated at sea, this also adds to the reason for the waste water having higher COD and TSS levels. Table 3.17 shows the reported waste water characteristics from fish filleting.

Parameter	Filleting of herring		Filleting of cod	
	Average (kg/m ³)	Range (kg/m ³)	Concentration (kg/m ³)	Load (kg/t fish)
BOD ₇	10000	5000 – 20000	600 – 1300	8 – 19
Fat	12000	2500 – 16000	50 – 70	0.3 – 1.4
Dry matter	20000	5000 – 28000		
Protein	6000			
Total nitrogen			100 – 600	0.3 – 3.1
Suspended solids				1.6 – 11.3
Water consumption (m ³ /t)		5		

Table 3.17: Waste water from fish filleting
[134, AWARENET, 2002]

In precooking, water is re-used several times and recovery can be made. About 3 – 4 g oil/kg fatty fish, protein and pieces of fish are released into the water with oil forming a layer on the surface. If the fish is made in brine, there is a high salt concentration in the waste water. Skin is removed from some species, such as mackerel, with the help of a warm caustic bath. Waste water is consequently alkaline and is treated by neutralisation.

The waste water contains blood, flesh, guts, soluble protein and waste material and is high in BOD, COD, TSS, FOG, and phosphates, as well as detergents and other cleaning agents.

Waste water production rates and characteristics depend highly on the production lines. Data for Germany are presented in Table 3.18.

Production	Waste water production (m ³ /t)	SS (mg/l)	BOD ₅ (mg/l)	Fats* (mg/l)
Herring	17 – 40	220 – 1520	2300 – 4000	190 – 450
Fresh fish	About 8	170 – 3650	1000 – 6250	46 – 2500
Smoking of fish	About 8	14 – 845	1000 – 1700	24 – 180
Salting of salmon	About 35			
Deep frozen fish	2 – 15			
Thawing		0 – 70	30 – 1800	4 – 46
*expressed as petrolether extract				

Table 3.18: Typical waste water production rates and characteristics for fish processing in Germany
[27, ATV, 2000]

3.3.2.3 Solid output

The solid wastes generated during fish processing range between 20 – 60 % of the catch, comprising skin, guts, bones, heads, cephalopods, feathers and shells. For example, when the fish quality is poor, soft fillets can get caught in the skinning knife. This decreases the yield and increases the production of by-products and waste.

Part of the waste water and almost all of the solid output may be used for different purposes. Fatty acids and flavours may be recovered from cooking water. Rejected fish are used in animal feed or for production of fish-meal and fish-oil and used afterwards in foodstuff, animal feed and coatings.

By-products from the filleting, skinning, cutting and canning steps are used for:

- production of foodstuffs, e.g. fish-meal, ingredients, surimi, polyunsaturated fatty acids, gelatine and collagen
- production of animal feed, e.g. fish protein, fish silage, fish protein hydrolysate, petfood, fish-oil and solubles
- production of fertilisers such as fish solubles and fish protein hydrolysate
- production of pharmaceuticals such as gelatine and collagen
- production of coatings, e.g. fish-oil and pearl essence, and adhesives such as fish glue
- production of leather.

Fluid lost from the fish may be treated anaerobically to produce biogas. Heads, shells, intestines and scraps have different applications, such as:

- production of animal feed, e.g. fish-meal, crustacean meal for cats and astaxanthin for aquaculture
- production of foodstuff, e.g. fish-meal, chitin and chitosan
- production of flocculants for waste water treatment, e.g. chitin and chitosan
- production of pharmaceuticals, e.g. chitin and chitosan.

Figure 3.3 shows consumption and emission levels of the process steps in fish canning.

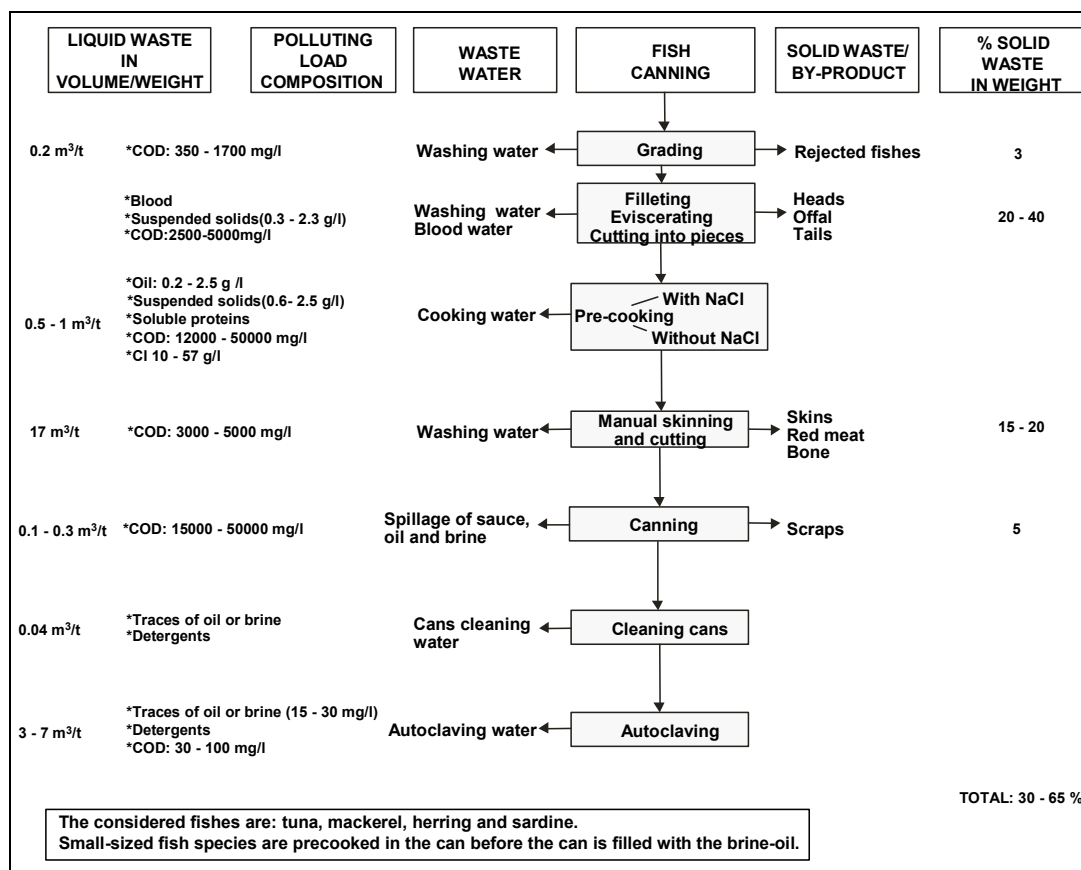

Figure 3.3: Consumption and emission levels of the process steps in fish canning [134, AWARENET, 2002]

Solid by-products of the filleting, curing, salting and the smoking of fish have similar uses as mentioned above for the canning of fish. Ash from shavings is generally disposed of with municipal solid waste. Figure 3.4 shows the consumption and emission levels of the process steps in filleting and preserving fish.

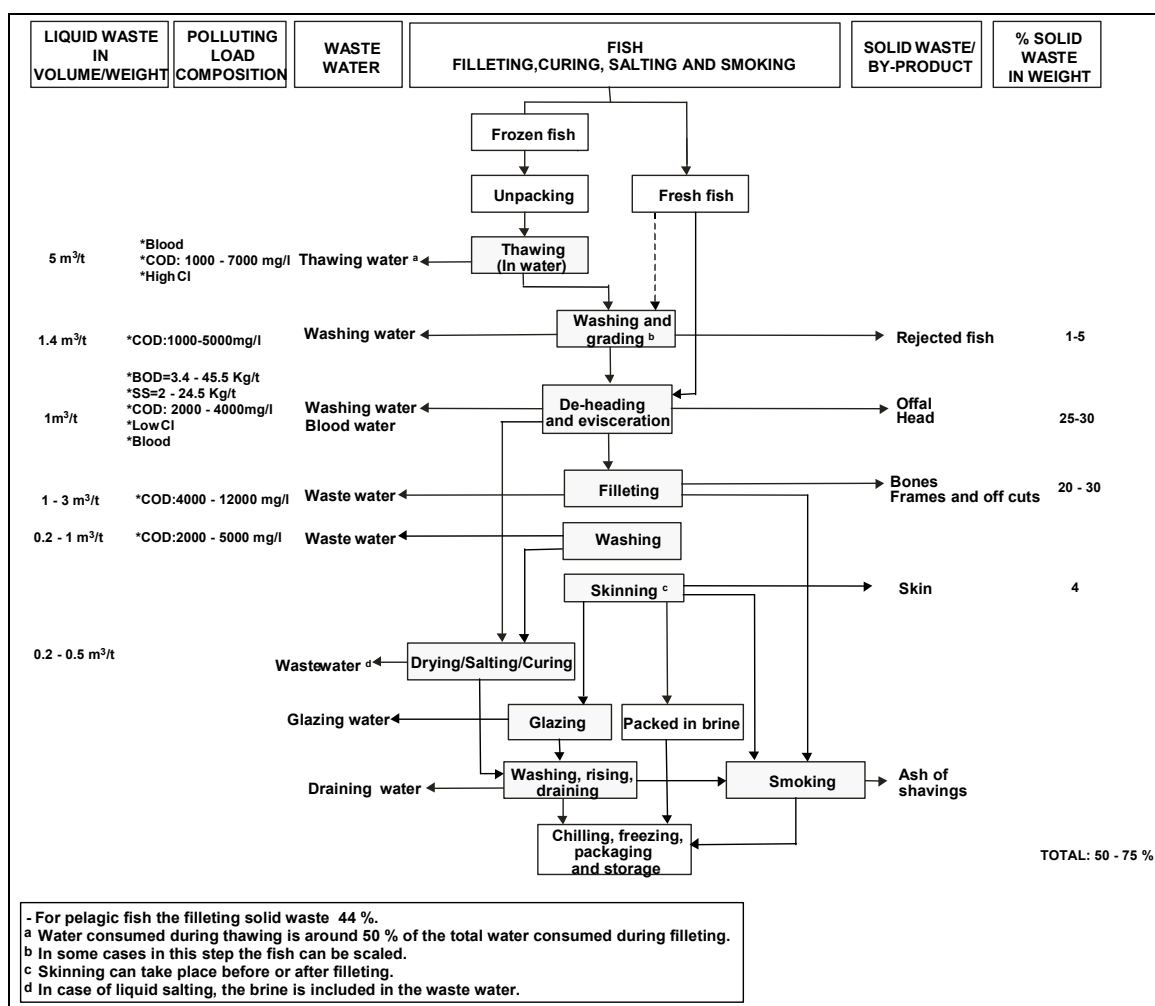

Figure 3.4: Consumption and emission levels of the process steps in filleting and preserving fish [134, AWARENET, 2002]

The main crustaceans processed and consumed in Europe comprise shrimps, prawns, lobsters, crayfish crabs and crabs. The main processing steps together with consumption and emission levels are presented in Figure 3.5.

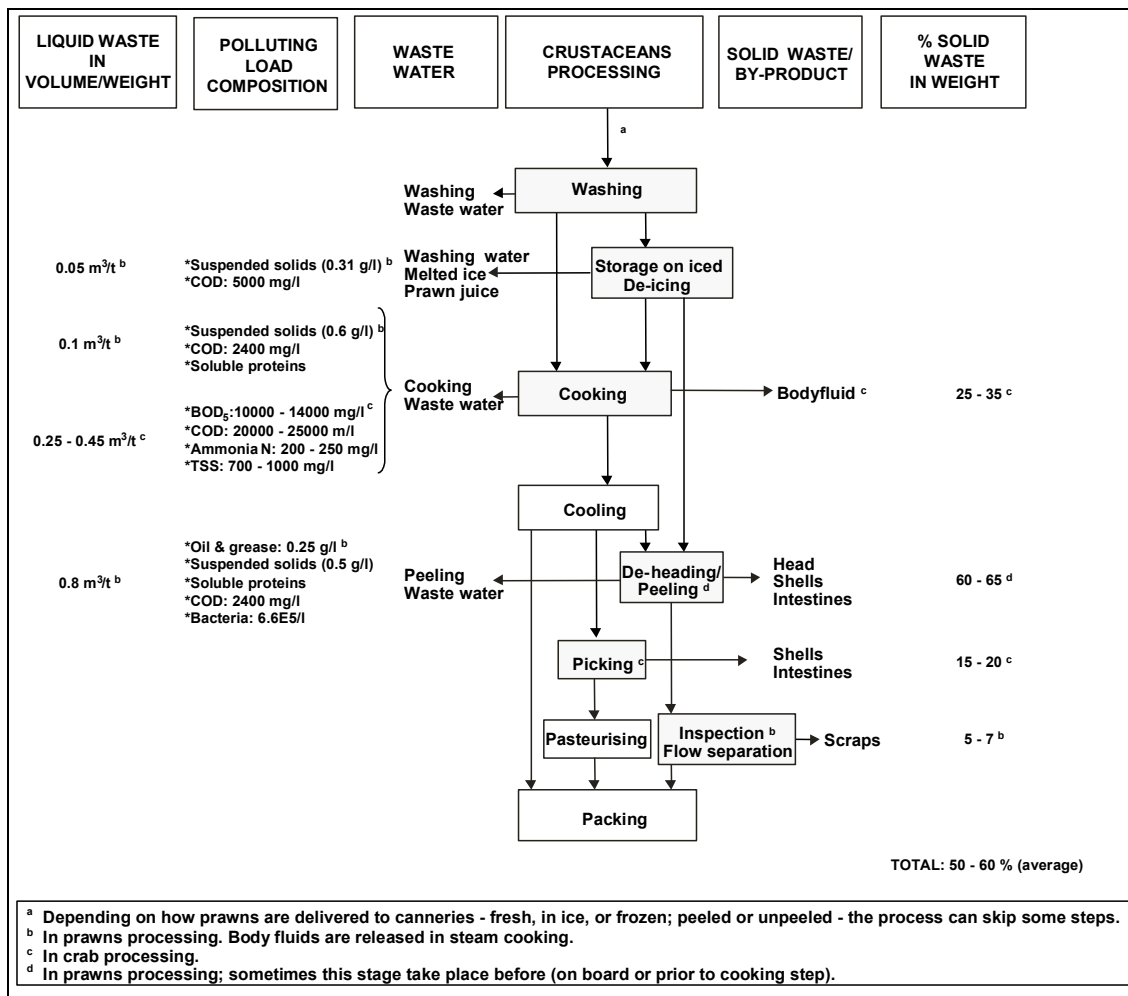

Figure 3.5: Consumption and emission levels of the process steps in crustaceans processing [134, AWARENET, 2002]

Sand and shell particles generated during the shell removal and washing steps of mollusc processing are used in the production of chemicals such as plastics and paints, construction materials and fertilisers. Fluid lost from the fish, e.g. clam juice, may be used in foodstuffs. Figure 3.6 shows the consumption and emission levels of the process steps in mollusc processing.

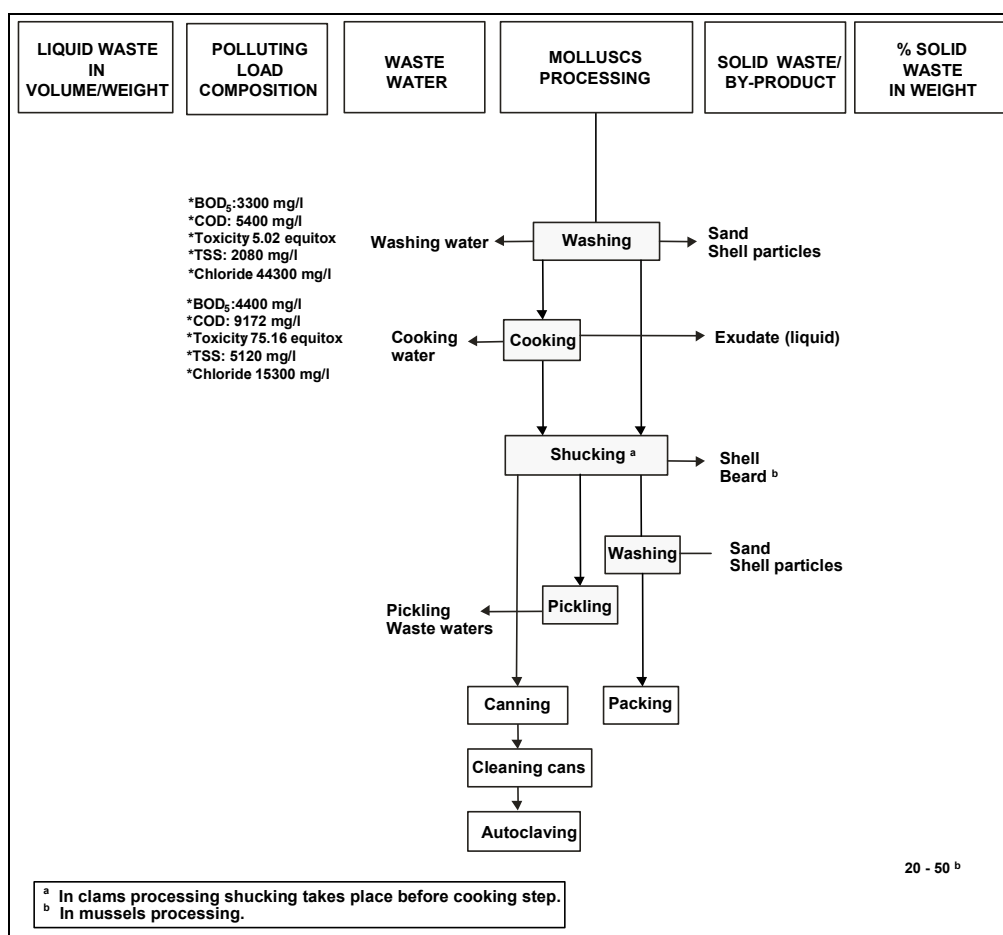

Figure 3.6: Consumption and emission levels of the process steps in mollusc processing [134, AWARENET, 2002]

3.3.2.4 Energy

The consumption of energy depends on the installation, the equipment and the fish manufacturing processes that take place. Processes, e.g. canning, that involve heating, cooling, production of ice, drying, evaporation and oil production consume more energy than those that do not, e.g. filleting, where energy consumption is low. On average, filleting consumes 65 - 87 kWh/t of fish and canning consumes 150 - 190 kWh/t of fish.

3.3.3 Fruit and vegetables

3.3.3.1 Water consumption

Water is used mainly during washing. It is also used during peeling and blanching. The fruit and vegetable canning industry in Greece consumes 7 - 15 m³ water per tonne of product. Table 3.19 shows water consumption levels reported by, and achieved in, fruit and vegetable installations. Water consumption levels reported for some processes in the fruit and vegetable sector are shown in Table 3.20.

Product category	Water consumption (m ³ /t product)
Canned fruit	2.5 – 4.0
Canned vegetables	3.5 – 6.0
Frozen vegetables	5.0 – 8.5
Fruit juices	6.5
Jams	6.0
Baby food	6.0 – 9.0

Table 3.19: Water consumption levels achieved in fruit and vegetable installations [140, World Bank (IBRD), et al., 1998]

Type of processing	Water consumption (m ³ /t finished product)
Deep frozen vegetables	2.5 – 5.0
non-peeled products, e.g. leeks, onions, aubergines, cabbage, blanched celery, rhubarb and courgettes	2.6
beans, peas, cauliflower, sprouts and flageolets	3.0
blanched leaf vegetables, e.g. spinach	5.1
peeled products, e.g. carrots, celery and potatoes	3.8
Preserved vegetables (range)	7 – 11
well managed	5.9
Potato processing (range)	4.5 – 9.0
well managed	5.1
Potato peeling company (well managed)	2.4

Table 3.20: Water consumption for some processes in the fruit and vegetable sector [5, Derden A Vercaemst P and Dijkmans R, 1999, 134, AWARENET, 2002]

Tomatoes are one of the most processed raw materials. Italy is the second largest producer in the world after the US, and the largest exporter of tomato products. Reported figures for water and energy consumption together with waste water and solid waste production in the different processing steps for canned peeled tomatoes and tomato juice are summarised in Table 3.21 and Table 3.22.

Canned peeled tomatoes (whole and cut)						
Unit operation		Water consumption	Waste water load	By-products/solid wastes	Electrical energy	Thermal energy
No.	Description	(m ³ /t)	(kg COD/t)	(kg/t)	(kWh/t)	(kg steam/t)
A.1	Materials handling and storage	0.2	1.5	10 – 15	1	
A.2	Sorting/screening, grading, dehulling, destemming/destalking and trimming	1	0.1	0.2	1.5	
A.3	Peeling (refining)	0.5 – 2	3 – 5	25 – 30	2.5	100
A.4	Washing	2	2	0.2	0.5	
B.1	Cutting, slicing, chopping, mincing, pulping and pressing		1			
B.2	Mixing/blending, homogenisation and conching					
C.5	Filtration		1			
E.2	Blanching		0.5		4 - 5	60
E.8	Pasteurisation, sterilisation and UHT	15 – 25 ⁽¹⁾			2	450 – 500
	Cans and bottles					200 – 300
F.1	Evaporation (for juice)	10 – 12 ⁽¹⁾			7 – 8	150 – 200
H.1	Packing and filling			0.5	1.5	
U.1	Cleaning and disinfection	1.5	1	0.2 – 1		
U.4	Vacuum generation	0.5			1 - 2	
	Overall totals of typical installations (all unit operations are not undertaken at each installation, so the totals are not the sum of the levels for each unit operation)	35 – 40	7 – 10	25 – 35	19 – 24	750 – 850
			6 – 8⁽²⁾			

⁽¹⁾Not discharged, but recycled
⁽²⁾Waste water – m³/t

Table 3.21: Consumption and emission levels for canning tomatoes [89, Italian contribution, 2001, 184, Italy, 2003]

Tomato juice, puree and paste (28 – 30 °Brix puree ⁽¹⁾)						
Unit operation		Water consumption	Waste water load	By-products/solid wastes	Electrical energy	Thermal energy
No.	Description	(m ³ /t)	(kg COD/t)	(kg/t)	(kWh/t)	(kg steam/t)
A.1	Materials handling and storage	5	6	12	0.4	
A.2	Sorting/screening, grading, dehulling, destemming/destalking and trimming	10	2		1.5	
A.3	Peeling (refining)			150 – 200	8 – 12	
A.4	Washing	15	5			
B.1	Cutting, slicing, chopping, mincing, pulping and pressing				2.5	
B.2	Mixing/blending, homogenisation and conching					
E.2	Blanching				15 – 25	700 – 900
E.8	Pasteurisation, sterilisation and UHT				0.5	60 – 80
F.1	Evaporation (liquid to liquid)	100 – 150 ⁽²⁾			60 – 80	1500 – 1800
F.2	Drying (liquid to solid)					
H.1	Packing and filling			1.5	3.5	10
U.1	Cleaning and disinfection		1			
U.4	Vacuum generation	1			4 - 5	
	Overall totals of typical installations (all unit operations are not undertaken at each installation, so the totals are not the sum of the levels for each unit operation)	130 – 180⁽²⁾	10 – 12	160 – 210	90 – 125	2300 – 2800
			60 – 80⁽²⁾			

⁽¹⁾ All figures are referred to 1 t of 28 – 30 °Brix tomato puree. Conversion coefficients for other final products: 7 – 12 °Brix puree – multiply by 0.3; 20 – 22 °Brix puree – multiply by 0.7, 36 – 40 °Brix puree – multiply by 1.3
⁽²⁾ Without cooling towers

Table 3.22: Consumption and emission levels for manufacturing of tomato juice, puree and paste [89, Italian contribution, 2001, 184, Italy, 2003]

3.3.3.2 Waste water

Waste water characteristics are affected by various factors. These include the raw material being processed, seasonal and source variations, unit operations, production patterns and operator practice. Table 3.23 shows data reported for canning fruits and vegetables in the US.

Parameter	Fruit	Vegetables
Waste water volume (m ³ /t raw material)	10.86	22.91
BOD ₅ (kg/t raw material)	11.8	13.0
TSS (kg/t raw material)	2.2	6.6

Table 3.23: Average waste water and water pollution generated in the US canning industry in 1975 [74, Greek Ministry for the Environment, 2001]

Typically, waste water is high in SS, sugars and starches. Residual pesticides that are difficult to degrade during waste water treatment may be a concern, especially with produce from countries with less stringent controls on pesticide use.

Reported levels of BOD and TSS in the waste water arising from the processing of various fruits and vegetables, are shown in Table 3.24 and Table 3.25.

BOD <500 mg/l		BOD 500 – 1000 mg/l		BOD 1000 – 2000 mg/l	
Product	TSS mg/l	Product	TSS mg/l	Product	TSS mg/l
Citrus	130	Apple juice	104	Frozen potatoes	1716
Asparagus	43 – 114	Strawberries	96 – 210	Dried potatoes	981
Broccoli	100 – 455	Baby foods	101 – 533	Apricots	33 – 387
Brussel sprouts	29 – 1680	Peeled tomatoes	280 – 1280	Mushrooms	33 – 467
Cauliflowers	18 – 113	Tomato products	512 – 1180	Peaches	164 – 1020
Dehydrated vegetables	168 – 778			Plums	60 – 187
Leafy greens	19 – 419				
BOD 2000 – 3000 mg/l		BOD 3000 – 5000 mg/l		BOD >5000 mg/l	
Product	TSS mg/l	Product	TSS mg/l	Product	TSS mg/l
Carrots	262 – 1540	Dried fruit	8 – 568	Beetroots	367 – 4330
Grape juice	216 – 228	Jams, jellies, preserves	404 – 711	Whole potatoes	1660 – 24300
Peas	79 – 673	Pears	84 – 702	Sweetcorn	131 – 2440
Potato crisps	1450 – 3910				

Table 3.24: BOD and TSS concentrations in waste water from fruit and vegetable processing [140, World Bank (IBRD), et al., 1998]

Type of operation	SS (mg/l)	COD (mg/l)	BOD ₅ (mg/l)	N _{tot} (mg/l)	P _{tot} (mg/l)
Vegetables, frozen vegetables, preserves, fruit and vegetable juices	700	5000	3000	150	30
Potato processing	700	10000	3000	150	200
Potato peeling	1100	6000	2500	200	30
Fruit and vegetable juices ¹					
Apples	33 ²	5500	2500	26.5	21
Apples (without pressing)	16.5 ²	5100	2500	27	23
Sour cherries	9 ²	4000	2300	15	
Blackcurrants	24 ²	4900	2600	13.5	12.5
Blackcurrants without pressing	21 ²	4600	2100	–	9
Carrots	24 ²	8600	2700		
¹) Rounded average figures					
²)Settleable solids after two hours, ml/l					

Table 3.25: Waste water characteristics from some fruit and vegetable processing [5, Derden A Vercaemst P and Dijkmans R, 1999, 65, Germany, 2002]

Specific waste water generation and pollution loads are presented in the next two tables. Table 3.26 shows reported loads per unit production that can be achieved by implementing pollution reduction measures, such as procuring clean raw fruit and vegetables, and the use of countercurrent systems for washing and recycling process water, although the specific techniques used for each example and the unit of product are not identified. Table 3.27 shows the waste water volume and water pollution per unit of product generated in the processing of some fruit.

Product	Waste water volume (m ³ /U)	BOD ₅ (kg/U)	TSS (kg/U)
Asparagus	69.0	2.1	3.4
Broccoli	11.0	9.8	5.6
Brussels sprouts	36.0	3.4	11.0
Carrots	12.0	20.0	12.0
Cauliflowers	89.0	5.2	2.7
Maize			
Canned	4.5	14.0	6.7
Frozen	13.0	20.0	5.6
Dehydrated onions and garlic	20.0	6.5	5.9
Dehydrated vegetables	22.0	7.9	5.6
Dry beans	18.0	15.0	4.4
Lima beans	27.0	14.0	10.0
Mushrooms	22.0	8.7	4.8
Onions, canned	23.0	23.0	9.3
Peas			
Canned	20.0	22.0	5.4
Frozen	15.0	18.0	4.9
Pickles			
Fresh packed	8.5	9.5	1.9
Process packed	9.6	18.0	3.3
Salting stations	1.1	8.0	0.4
Pimentos	29.0	27.0	2.9
Potatoes			
All products	10.0	18.0	16.0
Frozen products	11.0	23.0	19.0
Dehydrated products	8.8	11.0	8.6
Cabbage			
Canned	3.5	3.5	0.6
Cut	0.4	1.2	0.2
Snap beans			
Canned	15.0	3.1	2.0
Frozen	20.0	6.0	3.0
Spinach			
Canned	38.0	8.2	6.5
Frozen	29.0	4.8	2.0
Squash	5.6	17.0	2.3
Sweet potatoes	4.1	30.0	12.0
Tomatoes			
Peeled	8.9	4.1	6.1
Products	4.7	1.3	2.7
Unit of production (U) is not defined in [140, World Bank (IBRD), et al., 1998]			

Table 3.26: Waste water volume and water pollution per unit of product generated in the processing of some vegetables
[140, World Bank (IBRD), et al., 1998]

Product	Waste volume (m ³ /U)	BOD ₅ (kg/U)	TSS (kg/U)
Apricots	29.0	15.0	4.3
Apples			
All products	3.7	5.0	0.5
All except juice	5.4	6.4	0.8
Juice	2.9	2.0	0.3
Cranberries	5.8	2.8	0.6
Citrus	10.0	3.2	1.3
Sweet cherries	7.8	9.6	0.6
Sour cherries	12.0	17.0	1.0
Bing cherries	20.0	22.0	1.4
Cranberries	12.0	10.0	1.4
Dried fruit	13.0	12.0	1.9
Grapefruit			
Canned	72.0	11.0	1.2
Pressed	1.6	1.9	0.4
Peaches			
Canned	13.0	14.0	2.3
Frozen	5.4	12.0	1.8
Pears	12.0	21.0	3.2
Pineapples	13.0	10.0	2.7
Plums	5.0	4.1	0.3
Raisins	2.8	6.0	1.6
Strawberries	13.0	5.3	1.4
Unit of production (U) is not defined in [140, World Bank (IBRD), et al., 1998]			

Table 3.27: Waste water volume and water pollution per unit of product generated in the processing of some fruit
[140, World Bank (IBRD), et al., 1998]

Up to this point in this section, general data on water pollution from fruit and vegetable processing have been reported. In the following paragraphs, there is a breakdown of all unit operations that generate waste water. A reported typical process showing the waste water which arises from the major unit operations is shown in Figure 3.7.

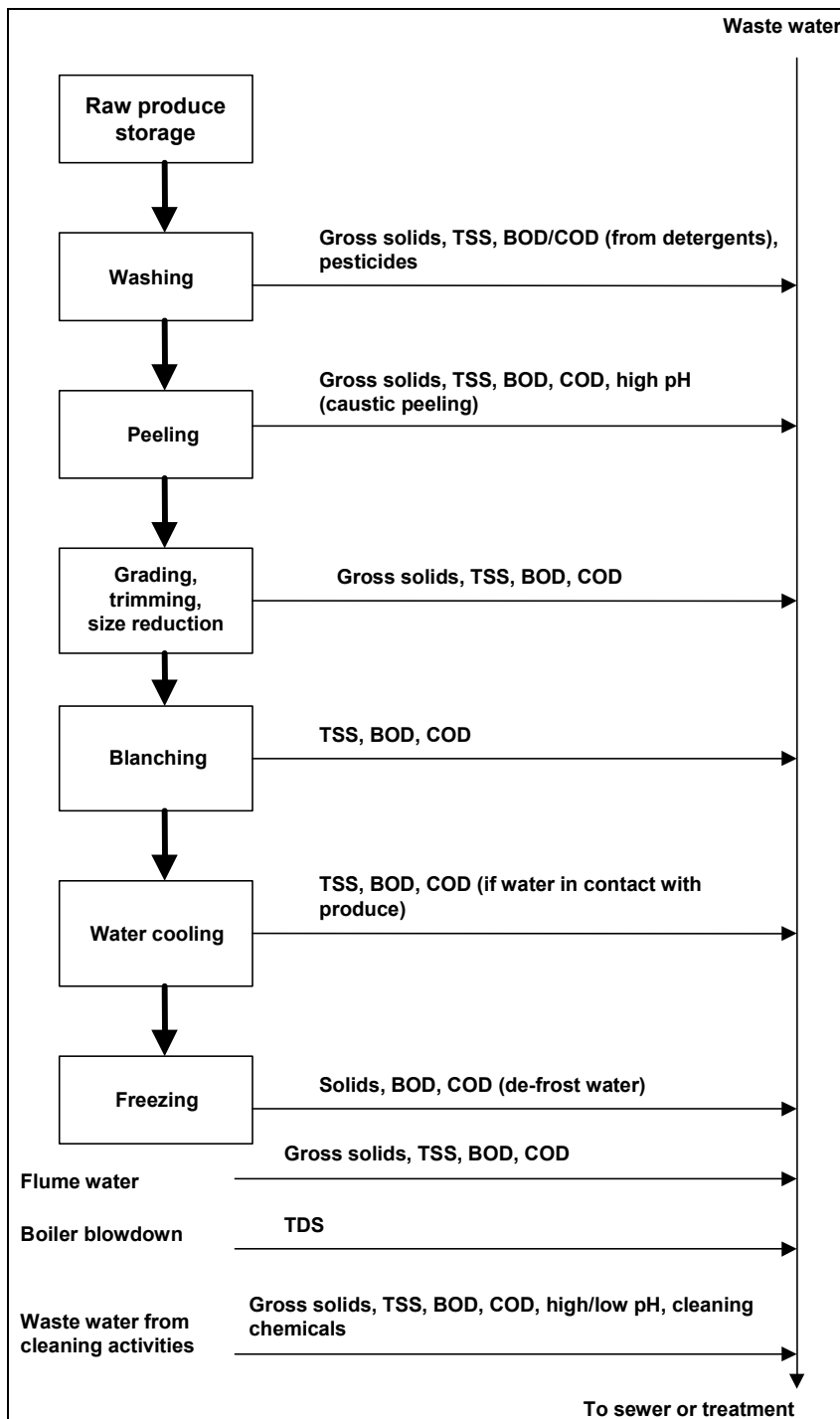

Figure 3.7: Waste water produced in fruit and vegetable processing
[13, Environment Agency of England and Wales, 2000]

The incoming produce is washed in chlorinated water to remove residual soil, stones and other debris and to reduce the microbial population. Large volumes of chlorinated water are required, especially for root vegetables which carry a lot of earth, and leafy vegetables which have a large surface area. Mechanical or air flotation techniques are used to aid soil removal and reduce the quantity of water used. Some recirculation or re-use of water from other operations is common. Waste water from pre-washing mainly contains field debris and soil particles with small fragments of the fruit or vegetables. If detergents are used to increase cleaning efficiency, they contribute to the COD of the waste water.

Most processes involve some type of grading, trimming and size reduction. Sometimes density graders containing brines of different strength are used. Discharge of significant quantities of brine can adversely affect any biological WWTP. Washing of the produce after these operations creates waste water containing soluble starch, sugars and acids. The use of water fluming to convey both the product and waste material causes additional leaching of these substances. Waste water from citrus fruit processing also contains pectic substances that can interfere with the sedimentation of SS.

All lines, equipment and process areas that are not in designated dry areas require wet cleaning, which generates waste water contaminated with raw material, product and cleaning chemicals. There are generally fewer requirements for aggressive chemicals in this sector than in others, unless oil or fat is used in processing.

3.3.3.3 Solid output

Large amounts of solid wastes are produced. These are organic materials, including fruit and vegetables discarded during selection, and those from processes such as peeling or coring. These typically have a high nutritional value and can be used as animal feed. Undesired materials discarded from the first processing steps include soil and extraneous plant material, spoiled food stocks, and some trimmings, peels, pits, seeds and pulp.

When caustic agents are used for peeling fruit and soft vegetables, a highly alkaline or salty solid waste is produced. High moisture content solid wastes can be generated by wet cleaning and re-use operations in which the dissolved solids or SS are concentrated and separated from the waste water.

Up to 50 % of fruit and typically 10 to 30 % of raw vegetable materials are wasted during processing. Part of the waste goes to the waste water and significant amounts of solid wastes are also generated. Some reported figures are shown in Table 3.28.

Raw material processed	Solid waste produced per tonne of product (kg)
Maize	40
Peas	40
Potatoes	40
Strawberries	60
Apples	90
All vegetables	130
Peaches	180
Broccoli	200
Carrots	200
Frozen peaches*	200
*Product	

Table 3.28: Solid waste produced during fruit and vegetable processing
[140, World Bank (IBRD), et al., 1998]

The reported types and amount of wastes produced in processing and preservation of fruit and vegetables are shown in Figure 3.8.

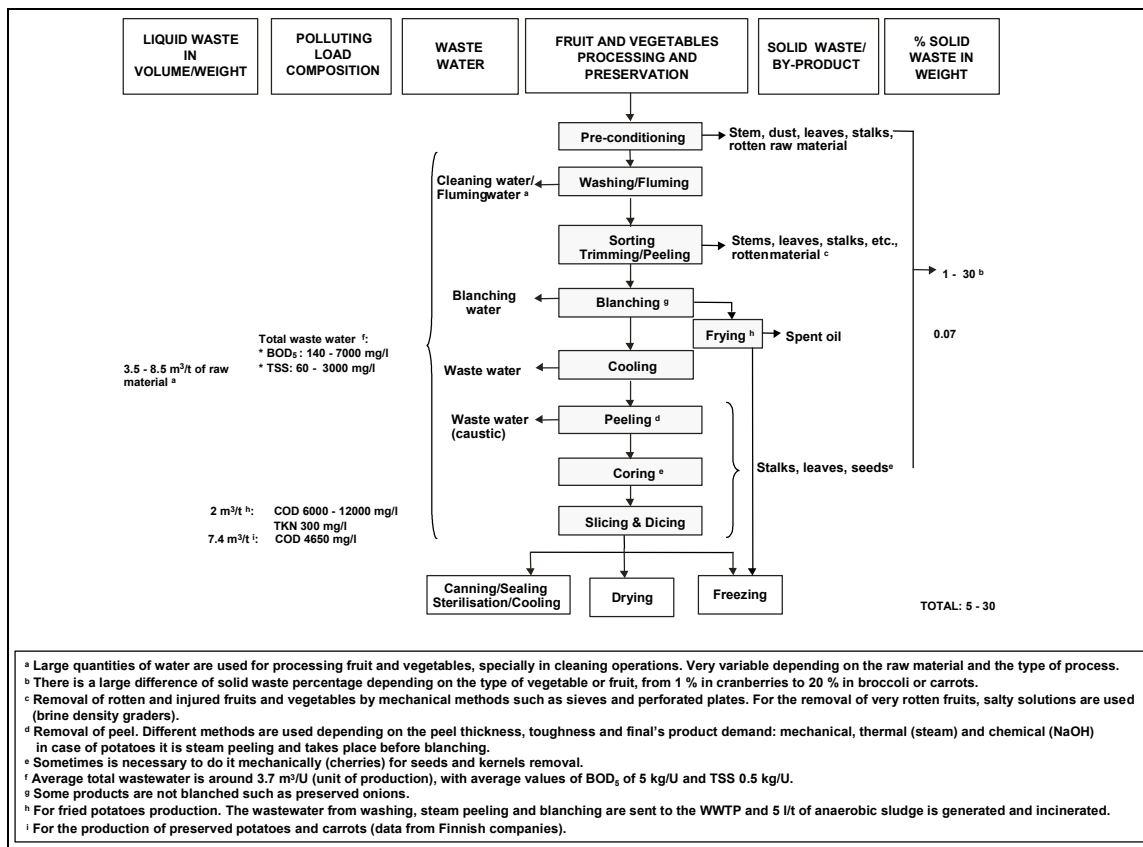

Figure 3.8: Type and amount of wastes produced in fruit and vegetable processing and preservation [134, AWARENET, 2002]

Some reported figures for producing fruit and vegetable juices are shown in Figure 3.9.

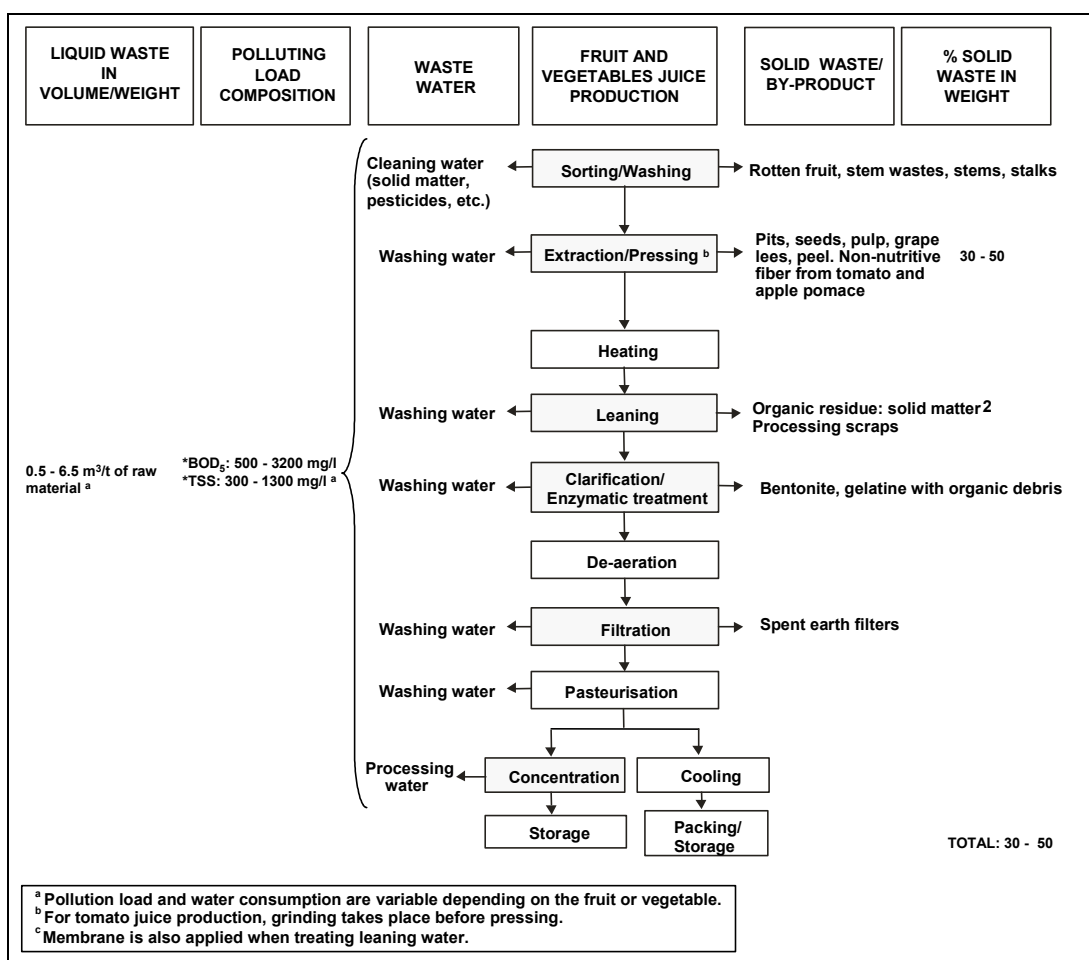

Figure 3.9: Type and amount of wastes produced in fruit and vegetable juice manufacturing [134, AWARENET, 2002]

If fruit and vegetables are treated with enzymes during juice manufacturing, less waste is produced. Table 3.29 shows the effects of apple and tomato processing in Hungary.

Raw materials	Type of pretreatment	Amount of waste (%)
Apple	With enzyme	8 – 18
	Without enzyme	10 – 25
Tomato	With enzyme	2 – 6
	Without enzyme	4 – 8

Table 3.29: Fruit and vegetable wastes in juice manufacturing in Hungary [134, AWARENET, 2002]

Solid wastes are normally used for the production of animal feed and organic fertilisers. They may also be used for producing food or other marketable products, or disposed of in waste water or to land. Possible re-use and disposal routes for the different solid wastes produced are as follows:

- non-nutritive fibre from apple pomace, dried citrus peel and lecithin from soybeans, may be used for the production of foods such as fermented foods, drinks, oils and proteins, or for the development of biopolymers for elaboration of biodegradable packing and construction material. Pectin is extracted from apples. Citrus is extracted during juice production
- citrus wastes, grape lees, grapes and potato processing wastes, may be used for biosynthesis of natural chemicals such as furfural, xylitol, alcohol, organic acids and polysaccharides, and pharmaceuticals such as hycogenin, antibiotics and vitamins. This option is growing as more opportunities are identified

- production of animal feed from sugar beet pulp, apple and tomato pomace and citrus pulp pellets, without or after treatment (physical, chemical, microbial, ensilage, production of microbial biomass). This use is limited by several factors, including shipping, putrefaction during storage and transport, and the presence of undesirable constituents such as alkalis or salt. Water content is the major contributor to shipping costs and to some extent to the putrefaction rates. Putrefaction reduces the shelf-life and value of the solid wastes and limits its use as animal feed
- peach and olive pits, rice hulls and straw, may be burnt directly, or converted to produce biogas or alcohol. Incineration is a viable option for solid wastes with a relatively low (<10 %) water content. Catalytic gasification or pyrolysis may also be applied
- composting and land application of organic waste is limited because of odour and possible soil contamination by leaching organics and salts.

Within the unit operations used in the fruit and vegetables sector, peeling is one of the major solid output and waste water producers.

Steam peeling is generally used for large quantities of potatoes, carrots and other tubers. Pre-processing includes the washing and the separation of mud and stones. This solid waste has no value for bioconversion. The waste produced in peeling has solids, mainly peel, which are separated by sedimentation from the aqueous phase, dried and may be composted. They may be further treated to recover minerals, fibre and phenolics. The aqueous phase goes for waste water treatment together with waste water from other processes. Its pollution, before discharge to MWWTP, expressed in COD is about 4000 mg/l. Soluble vitamins, starch, fibre and tissue fluid may be recovered from this waste water.

Mechanical peeling is used for small quantities of potatoes, carrots, apples, pears, etc. or when vegetables are used for catering or in institutional kitchens. The peeling is often performed outside the main processor. There are numerous peeling companies with varying capacity and equipment. The unit operations are basically the same as in steam peeling. The processing starts with the separation of mud and stones similar to the step for the steam peeling process.

The peeling consists of three consecutive steps: mechanical pre-peeling, using, e.g. carborundum; knife peeling and then washing. Waste water is produced in all three steps. After sedimentation, the aqueous phase goes for waste water treatment. Its pollution expressed in COD is about 5000 mg/l. The separated solid phase is normally composted. Vitamins, starch, fibre and minerals may be recovered.

Knife peeling produces a similar output as steam peeling and it can be used similarly, either directly as animal feed or for recovery of its components. About 60 % of the total organic solid waste produced comes from pre-peeling, by abrasion peeling and the rest is from knife peeling. After cutting, defective pieces which are, e.g. too dark or too small, are separated and used as animal feed. However, especially in carrot processing, several valuable substances such as vitamin C, fibre, phenolic compounds and carotenoids, can be recovered from this by-product. The next step is rinsing, and in the case of potato processing, this is usually combined with the addition of browning inhibitors or sulphites before transporting the peeled product to the main processing facility.

Data comparing outputs from processes using either steam peeling or a combination of abrasion peeling and knife peeling is shown in Figure 4.50 and Figure 4.51.

3.3.3.4 Energy

Processes involving heating, cooling, drying, evaporation, sterilisation, pasteurisation and blanching consume significant energy.

Almost every process step requires electricity. For steam production, natural gas boilers can be used. The frozen vegetable sector is a large consumer of electricity and natural gas. Deep freezing is the process which uses the most electricity.

During deep freezing, cooling to a very low temperature level, i.e. -30 to -40 °C, is necessary. During this process, energy is consumed at a rate of 80 to 280 kWh_e/t of frozen vegetables. Other processes, e.g. washing, require less electrical energy, a maximum of 28 kWh_e/t of frozen product.

Deep freezing carrots consumes ±8 kWh_e/t and freezing salsifies consumes ± 20 kWh_e/t and these require a lot of electrical energy for sorting. Washing spinach for deep freezing consumes ± 4 kWh_e/t and is electricity intensive. The mechanical processing of frozen beans and salsifies consumes ± 6 kWh_e/t and ± 9 kWh_e/t respectively, i.e. much more electricity compared with other vegetables.

The electricity consumption of the belt blancher with air cooling, which produces 7 to 30 kWh_e/t of frozen product, is significantly higher than that of the belt blancher with water cooling, which produces 2 to 9 kWh_e/t of frozen product, or the drum blancher with countercurrent water cooling, which produces 1 to 2.6 kWh_e/t of frozen product. Spinach requires most electricity for intermediate processes such as packing or making of portions

Steam is used for peeling and blanching. Steam peeling uses approximately five times more steam than caustic peeling. Belt blanching with water cooling consumes approximately half the energy of belt blanching with air cooling or drum blanching with countercurrent water cooling. For storage, electricity consumption is between 20 and 65 kWh_e/m³ of storage space/year.

3.3.3.5 Data for some fruit and vegetable products

3.3.3.5.1 Fresh-pack

Fresh-pack fruit and vegetables require minimal processing. Water consumption is mainly for produce washing, transport flumes and line cleaning. Processing installations are often close to growing areas, creating opportunities for the use of waste water in irrigation. Some fresh-pack vegetables require peeling.

3.3.3.5.2 Preserved fruit and vegetables

Fruit and vegetables that are to be preserved undergo further processing. The most common types are discussed below.

Many vegetables and some fruits require **peeling**, which can be a major source of BOD and TSS and represent a substantial proportion of the total waste water volume. Peeling is usually followed by washing.

Conventional steam peeling uses large quantities of water and produces waste water with high levels of product residue. At potato processing installations, the peelings can contribute up to 80 % of the total BOD. In fruit processing, peeling waste water can account for as much as 10 % of the total waste water flow and 60 % of the BOD. Water cooling in steam peeling increases water consumption.

Caustic peeling causes higher solubilisation of material and consequently a higher COD, BOD and SS load than mechanical peeling, which is a combination of knife and abrasion peeling. Furthermore, the use of caustic in peeling may lead to pH fluctuations in the waste water. Dry caustic peeling tends to have a lower caustic consumption than wet methods and can greatly reduce the volume and strength of the waste water from this operation and allows for the collection of peel as a pumpable slurry.

Blanching is used in most vegetables destined for canning, freezing or drying. Typically, it is carried out using hot water or steam. If the produce is to be frozen, blanching is followed by water or air cooling.

Both water and steam blanching produce waste water high in BOD; in some cases, over half of the total BOD load. The volume of waste water is less with steam blanching than with water blanching. The quantity of waste water from steam blanching can be reduced by steam recycling, effective steam seals and equipment designs that minimise steam consumption. Waste water can be completely eliminated by microwave blanching, which is used in Europe and Japan.

For fruit and vegetable products which can be microbiologically sterilised at temperatures not higher than 100 °C, sterilising, which, in this case, is generally named **pasteurisation**, can be carried out in installations using hot water or steam at atmospheric pressure. The most traditionally used low temperature process is the open bath. These are metallic cylindrical or parallel piped baths, containing water heated by direct steam injection with a nozzle placed on the bottom. These baths are not generally equipped with automatic thermostats. The operating temperature is the boiling point of water at atmospheric pressure with a continuous flow of excess steam. The packs to be sterilised are loaded into large baskets; the baskets, by means of pulleys, are immersed in the baths and treated by boiling water for the required time. **Cooling** does not generally take place in the sterilising bath itself, which is thus ready to receive a new load, but in another bath containing cold running water.

For products **packaged** in glass containers, linear tunnels are used, including the phases of feeding, preheating, heating, precooling, cooling and drying. Heating is by means of saturated dry steam or hot water coming down on the packs from the top from a series of nozzles or by simple percolation from a perforated ceiling. The water is then recovered in recycling baths equipped with direct or indirect steam heating. **Cooling** is also carried out by sprinkling with water. Precooling water is partially recycled, thus keeping it at around 60 °C. The **drying** step is indispensable for the prevention of marks on the cap and above all to enable labelling and secondary online packaging. It is carried out by means of hot or cold air blowers. To sterilise low acidity products, which require temperatures greater than 100 °C, various means of heating can be used, although autoclaves are predominantly used. All high temperature sterilisers operate at pressure higher than atmospheric.

Single-phase acid products or products with small pieces, such as fruit juices, vegetable juices and purees, tomato purees, jams, marmalades and jellies, can be hot-filled. Heat sterilisation may be carried out before packaging because of the low pH and/or a_w of these products. The hot product itself sterilises the metal or glass container, so that only the caps and necks of bottles, and lids of small containers, need to be sterilised separately. Filling and hermetic closure of the container need to be carried out before the product cools down. The filling temperatures must be kept between 85 – 92 °C. In all cases, the subsequent cooling is undertaken with sterilised chlorinated water.

Finally, **aseptic packaging** is undertaken. It is a combination of sterilising plants for the product and for the containers of various types, with an isolated system of filling and sealing. The aseptic packaging of liquid products involves the following sequence of operations: heating at pre-fixed temperatures; transfer to a holding section; cooling at a temperature of around 35 °C; filling of the pre-sterilised pack, opening and kept in conditions of perfect asepsis; and closure of the pack. The type of heat-exchanger is selected according to the rheological properties of the fluid. They can be tubular of the circular crown type or scraped-film exchangers for products with high Re values and tube-in-tube-in-tube exchangers or plate exchangers for products with low Re values [124, Italy, 2002].

Pickling is also an important operation for the preservation of fruit and vegetables. The following process phases produce brine; fresh brine after slashing and salting (100 – 150 kg/t of white cabbage) and sour brine in the course of lactic fermentation (150 – 180 kg/t of white cabbage). The blanching process is carried out in sour brine, which produces blanching brine. Table 3.30 shows the waste water values of brine during the production of cabbage.

Brine	pH	Concentration in waste water		
		BOD ₅ (mg/l)	COD (mg/l)	Chloride (mg/l)
Fresh brine	6.0 – 6.2	10000 – 30000	15000 – 40000	12000 – 15000
Fermentation brine	3.8 – 4.2	17000 – 50000	25000 – 75000	2500 – 20000
Blanching brine	3.8 – 4.0	40000 – 55000	65000 – 85000	–

Table 3.30: Waste water values of brine during the production of Sauerkraut

3.3.3.5.3 Frozen vegetables

Materials handling and storage (A.1)

In manufacturing frozen vegetables, transportation and storage operations require energy as follows [32, Van Bael J., 1998]:

- the transportation of frozen vegetables requires 2 – 14 kWh_e/t frozen vegetables. For most production lines, the electrical rating of the belts is between 5 – 30 kW_e
- the storage of vegetables needs 20 – 65 kWh_e/m³ storage/year electricity and about 26.389 kWh/m² (95 MJ/m²) storage/year is needed in the form of hot water.

Data from the literature show that the average energy balance is made up as follows [32, Van Bael J., 1998]:

- 11 % for the evaporator fans
- 5 % for the condenser fans
- 7 % for peripheral equipment
- 77 % for compressors, of which 21 % is used for heat input via doors/hatches, 48 % used due to losses via the building shell, and 8 % through the product.

Sorting/screening, grading, dehulling, destemming/destalking and trimming (A.2)

The sorting operation has an electrical energy consumption of 0 – 20 kWh_e/t frozen vegetables [32, Van Bael J., 1998]. Table 3.31 shows the electricity consumption during the sorting of vegetables.

Product	Electricity consumption (kWh _e /t frozen vegetables)
Spinach	0
Cauliflowers	1
Peas	4
Sprouts	4
Beans	5
Carrots	8

Table 3.31: Electricity consumption during the sorting of vegetables [32, Van Bael J., 1998]

Peeling (A.3)

In frozen vegetable processing, salsifies and carrots are peeled before being mechanically processed. Caustic peeling and steam peeling are two methods used. Caustic peeling needs less energy, both in terms of electricity consumption and steam consumption, than steam peeling, but creates more load for the WWTP [32, Van Bael J., 1998]. Table 3.32 shows the energy carrier and consumption for the caustic peeling of vegetables and Table 3.33 shows the energy carrier and consumption for the steam peeling of vegetables.

Energy carrier	Approximate consumption
Hot water (kWh/t frozen vegetables)	0
Steam (t/t frozen vegetables)	0.16
Steam pressure (bar)	7
Electricity (kWh/t frozen vegetables)	2

Table 3.32: Energy carrier and consumption for the caustic peeling of vegetables [32, Van Bael J., 1998]

Energy carrier	Approximate consumption
Hot water (kWh/t frozen vegetables)	0
Steam (t/t frozen vegetables)	0.9
Steam pressure (bar)	4 – 15
Electricity (kWh/t frozen vegetables)	3.5

Table 3.33: Energy carrier and consumption for the steam peeling of vegetables [32, Van Bael J., 1998]

Washing (A.4)

Washing, as used in the production of frozen vegetables, needs 0 – 5 kWh_e/t frozen vegetables. Certain vegetables, e.g. sprouts and cauliflowers, do not require any washing and thus do not consume energy [32, Van Bael J., 1998]. Table 3.34 shows the electricity consumption for the washing of vegetables.

Product	Electricity consumption (kWh _e /t frozen vegetables)
Sprouts	0
Cauliflowers	0
Beans	0.5
Carrots	2.5
Salsifies	3
Peas	3
Spinach	5

Table 3.34: Electricity consumption for the washing of vegetables [32, Van Bael J., 1998]

Cutting, slicing, chopping, mincing, pulping and pressing (B.1)

Some vegetables are cut before deep freezing. The electrical energy consumption is up to 9 kWh/t frozen vegetables. Table 3.35 shows the electricity consumption of mechanical processing of vegetables before freezing.

Product	Electricity consumption (kWh _e /t frozen vegetables)
Peas	0
Sprouts	0
Spinach	0
Carrots (sliced)	1
Carrots (diced)	2.5
Salsifies	6
Beans	9
Peas	0

Table 3.35: Electricity consumption of mechanical processing of vegetables before freezing [32, Van Bael J., 1998]

Carrots, salsifies and beans require a reasonable amount of electrical energy for mechanical processing. Other vegetables examined do not require any electricity at all [32, Van Bael J., 1998].

Blanching (E.2)

Drum and belt blanchers are used in manufacturing deep frozen vegetables. Energy consumption depends on, not only the type of blanching device, but also the type of subsequent cooling step. Typical energy consumption levels are shown in Table 3.36 and Table 3.37.

Energy carrier	Approximate consumption
Hot water (kWh/t frozen vegetables)	0
Steam (t/t frozen vegetables)	0.16
Steam pressure (bar)	7
Electricity (kWh _e /t frozen vegetables)	0.5 – 1.3

Table 3.36: Energy source and consumption for drum blanching in the deep freezing of vegetables [32, Van Bael J., 1998]

Energy carrier	Approximate consumption
Hot water (kWh/t frozen vegetables)	0
Steam (t/t frozen vegetables)	0
Steam pressure (bar)	0
Electricity (kWh _e /t frozen vegetables)	0.5 – 1.3

Table 3.37: Energy source and consumption for countercurrent water cooling of vegetables processing [32, Van Bael J., 1998]

Furthermore, the electricity consumption for the production of ice-water is included in the electricity consumption shown for deep freezing. For example, in terms of energy consumption, the belt blancher with water cooling has the lowest total consumption. The heat released by the cooling of the product in the cooling zone is used to preheat the vegetables. In this way, less steam is necessary for blanching. Table 3.38 shows the energy carrier and consumption for belt blancher with water cooling in vegetable processing and Table 3.39 shows the energy carrier and order of magnitude indicators of the belt blancher with air cooling in vegetable processing.

Energy carrier	Approximate consumption
Hot water (kWh/t frozen vegetables)	0
Steam (t/t frozen vegetables)	0.09
Steam pressure (bar)	7
Electricity (kWh _e /t frozen vegetables)	2 – 9

Table 3.38: Energy carrier and consumption for a belt blancher with water cooling in vegetable processing [32, Van Bael J., 1998]

Energy carrier	Order of magnitude indicators
Hot water (kWh/t frozen vegetables)	0
Steam (t/t frozen vegetables)	0.16
Steam pressure (bar)	7
Electricity (kWh _e /t frozen vegetables)	7 – 30

Table 3.39: Energy carrier and order of magnitude indicators of a belt blancher with air cooling in vegetable processing [32, Van Bael J., 1998]

With regard to electricity consumption, the drum blancher for countercurrent water cooling has the lowest consumption. The water consumption for such an installation is rather high. The use of heavy duty fans (60 kW_e) in the belt blancher with air cooling, make the electricity consumption high for this type of operation [32, Van Bael J., 1998].

3.3.3.5.4 Juices

Energy is consumed when the juice is concentrated by evaporation and during pasteurisation. Waste water is produced from the condensate during evaporation and during start-up, product change-over and cleaning of pasteurisers. Solid wastes are produced during the pressing of fruit and vegetables. For example, 2 % of tomatoes and 30 % of citrus fruits may be lost as solid wastes during pressing [184, Italy, 2003].

3.3.3.5.5 Other products

Jams, jellies and preserves are based on the production of fruit gels, that come from extracted juices, purees or the whole fruit respectively. Fruit gels are composed of pectin, acid, sugar and water. The use of sugar and additional cooking tends to increase the BOD of waste water compared with most other fruit processing. The presence of natural or added pectin in the waste water may have an adverse effect on solids settling.

3.3.4 Vegetable oils and fats

3.3.4.1 Water consumption

The processes with the most significant water consumption are crude oil production; chemical neutralisation and subsequent oil washing and deodorisation [182, Germany, 2003]. The water consumption depends on the type of process, e.g. water consumption for pressing-only is minimal, on the type of cooling and vacuum installation, and on the type and age of oilseeds, e.g. soft seeds like rapeseed require different amounts of water than soybeans [109, CIAA-FEDIOL, 2002, 182, Germany, 2003].

During crude oil production, 0.2 – 14 m³ water/t oilseed are consumed for cooling purposes. Chemical neutralisation of crude oil consumes water at a rate of 1 – 1.5 m³/t of product. Deodorisation of neutralised and bleached oil and bleached edible fat consumes 10 – 30 m³/t product. The water consumed during the hardening of vegetable oil is mainly used for cooling and vacuum purposes and ranges from 2.2 – 7 m³/t oil.

In the chemical refining of edible oil, the following substances are used:

- demineralised water: 0.1 – 0.3 m³/t oil
- drinking water: 0.05 – 0.3 m³/t oil
- cooling water: 0.1 – 0.2 m³/t oil
- H₂SO₄: 50 – 250 kg/t soap.

3.3.4.1.1 Olive oil

Olive oil producers use about 12 million tonnes of water per year [142, IMPEL, 2002], corresponding to about 5 m³ water/t olive oil produced.

3.3.4.2 Waste water

Seed dressing and edible oil processing can generate as much as 10 – 25 m³ of waste water/t product [140, World Bank (IBRD), et al., 1998]. Specific waste water production is generally in the range of 3 – 5 m³/t feedstock. The amount of waste water highly depends on the type of oil source and the technology used. For example, rapeseed crude oil production uses pressing and solvent extraction and results in 2.5 – 3.0 m³ waste water/t rapeseed (7 – 12 m³/m³ crude oil), where the production of refined oil from rapeseed may result in 10 – 12 m³ waste water/t rapeseed [134, AWARENET, 2002].

Waste water characteristics of vegetable oil manufacturing, from several sources, reported using various units, are shown in Table 3.40, Table 3.41 and Table 3.42.

Production sector	Unit	Waste water volume
Production of crude vegetable oils/fats		
Seed processing		
Waste water	(m ³ /t seed)	0.2 – 0.5
Cooling water	(m ³ /t seed)	0.2 – 14
Refining of crude vegetable oils/fats		
Acid water from soap splitting in classic oil neutralisation	(m ³ /t) *	1 – 1.5
Waste water from installation cleaning	(m ³ /t) *	up to 0.5
Condensed vapours from deodorisation	(m ³ /t) *	0.01 – 0.1
Condensed vapours if steam ejectors (boosters) are used for vacuum generation for deodorisation	(m ³ /t) *	0.02 – 0.4
Barometric falling water from vacuum end stages of distillative neutralisation and from deodorisation (without recirculation)	(m ³ /t) *	10 – 30
Waste water from other vacuum equipment	(m ³ /t) *	approximately 1.5
Margarine production		
Rinsing and cleaning processes	(m ³ /t finished product)	0.75 – 2
Water input for evaporation	(m ³ /t finished product)	0.1**
* In relation to finished refined oil		
** For a refrigeration capacity of 15 – 20 kW/t finished product		

Table 3.40: Waste water production in vegetable oil manufacturing steps [65, Germany, 2002, 109, CIAA-FEDIOL, 2002]

Process/unit operation	Parameter	Level
Crude oil production (seed processing)	COD load	0.1 – 1.0 kg/t seed processed
Chemical neutralisation and soap splitting	Waste water volume	1 – 1.5 m ³ /t refined product
	COD load	≤5 kg/t refined product
Deodorisation	Waste water volume	10 – 30 m ³ /t refined product (once through system)
	COD load	≤7 kg/t refined product
Conventional chemical refining of edible oil	Waste water volume	25 – 35 m ³ /t refined product
	COD load	<15 kg/t refined product
Combined edible oil production and processing	COD/BOD ₅ ratio of waste water	1.5 – 2 (normally)

Table 3.41: Waste water characteristics in vegetable oil processing [182, Germany, 2003, 185, CIAA-FEDIOL, 2004]

Source	Volume m ³ /t ¹	BOD ₅ mg/l	COD mg/l	FOG mg/l	SS mg/l
Neutral oil washing	0.1	1000	15000	100 - 500	n.d. ³
Neutralisation reaction pH = 10 – 12	2.1 ²	4300	7200	670	2900
Barometric condensers pH = 6.5 – 7.5	2	140 – 200	500 – 600	20 – 200	40 – 100
Steam boiler	10 % of steam	20	40	–	100
Water softening	5 % of steam	20	40	–	100
Floor and equipment cleaning	0.1	1500	2000	n.d.	300

¹per t of crude oil ²per t of ffa ³n.d. = no data

Table 3.42: Reported untreated waste water characteristics in vegetable oil refining (cornflower, cottonseed and sunflower)

[74, Greek Ministry for the Environment, 2001]

3.3.4.2.1 Olive oil

Traditional olive oil production, also called pressing, generates about 2 to 5 litres of waste water per litre of oil produced, the three-phase continuous olive oil extraction generates about 6 to 8 litres of waste water per litre of oil produced, whereas the two-phase continuous olive oil extraction generates only about 0.33 – 0.35 litres of waste water per litre of oil produced. Table 3.43 shows the characteristics of olive oil waste water using different extraction techniques.

Technology	Waste water volume (m ³ /t olive oil)	BOD ₅ (mg/l)	COD (mg/l)	TSS (mg/l)	pH
Traditional extraction (pressing)	2 – 5	22000 – 62000	59000 – 162000	65000	4.6 – 4.9
Three-phase extraction	6 – 8	13000 – 14000	39000 – 78000	65000	5.2
Two-phase extraction	0.33 – 0.35	90000 – 100000	120000 – 130000	120000	4.5 – 5.0

Table 3.43: Characteristics of olive oil mill waste water

[74, Greek Ministry for the Environment, 2001, 86, Junta de Andalucia and Agencia de Medio Ambiente, 1994]

3.3.4.3 Air emissions

Dry dust is generated during seed delivery, silo storage, seed cleaning, seed preparation, meal shipment and indoor transportation/conveying. Wet dust can arise during seed preparation, meal drying and cooling, and indoor transportation/conveying.

If solvent extraction is applied, leakages and transportation can cause losses to the air. Following the extraction step, emissions of solvent (hexane) may occur during drying, cooling, storage and the transportation of meal and crude oil. Air emission levels for hexane, associated with various seed feedstocks, are shown in Table 3.44.

Feedstock	Hexane output (kg hexane/t raw seed)
Soy beans	0.5 – 1.0
Rapeseed	0.5 – 1.2
Sunflowerseed	0.5 – 1.2
Linseed	about 2.0
Castor	>3.0

Table 3.44: Hexane emission to air

[65, Germany, 2002]

In some seeds, e.g. rapeseed, the sulphur content may be high. Enzymatic and biological processes may convert sulphur compounds into hydrogen sulphide. No emission data have been reported yet during storage but significant hydrogen sulphide concentrations have been detected in the exhaust air of extractors [65, Germany, 2002]. Air emission types during the manufacture of crude vegetable oils are shown in Table 3.45.

Degumming	Neutralisation	Bleaching	Deodorisation	Hardening
	Volatile compounds	Odour	Ffa Volatile compounds Odours	

Table 3.45: Summary of air emissions in the manufacturing of crude vegetable oils [10, Environment Agency of England and Wales, 2000, 74, Greek Ministry for the Environment, 2001]

Odour is produced in all steps where heating is involved. It results from the volatile fatty acids, organic nitrogen compounds and, in the case of rapeseed, hydrogen sulphide and organic sulphur compounds.

3.3.4.4 Solid output

Depending on the type of vegetable, i.e. oilseed or oilfruit, the raw materials for vegetable oil production can almost completely be converted into products, e.g. vegetable oil, protein rich meal, fatty acids and lecithin, or by-products, e.g. for human food, animal feed and pharmaceutical products.

Solid waste, e.g. leaves, wood, pieces of metal and stones, is generated in the raw material's primary treatment step (cleaning and hulling). This is separated during the cleaning of the raw material by wind sifters, magnet separators and sieves. In oilseed production, this fraction is less than 1 % of the processed seed. Metals are sent for recycling or disposal and the remainder, such as stones and sand, is disposed of. Dust may be incinerated. In the pressing/centrifuging step, used filter clothes from seed pressing are produced and are also disposed of [161, Verband Deutscher Oelmuehlen, 2003].

In the case of chemical refining, soap stock is produced during the neutralisation of crude oil. This consists mainly of NaOH saponified ffa, but also contains phosphatides, proteins and other compounds. Normally, it is further processed in the refinery by splitting the soaps and regaining the fatty acids (acid oil). In some countries, it is possible to mix the soap stock from the chemical refining of vegetable oil with other ingredients for the production of low quality soaps or for use in meal for animal feed.

The production of solid wastes from vegetable oil refining and processing is dependent on the specific site. In bleaching operations, spent bleaching earth containing 20–40 % fat is produced. This makes the waste prone to spontaneous combustion. In production installations, which exclusively refine and modify edible oil, the spent bleaching earth is utilised by third parties for energy production by co-fermentation to produce biogas or to make bricks [182, Germany, 2003]. The spent catalyst is recycled to third parties for regeneration.

In mixed production installations, which produce crude oil and meal, and refine/modify the edible oil, there are further opportunities for utilisation of components of the raw material and of wastes. For example, utilisation of phospholipids in meal and utilisation of spent bleaching earth in meal, both as animal feed. The precondition for the latter example is the absence of nickel catalyst residues [161, Verband Deutscher Oelmuehlen, 2003].

Deodoriser distillate, collected from the steam distillation of refined edible oils, has a variable composition depending on the raw material and the refining process. When arising from physical refining, if the pesticide content is low, it can be used in the feed industry. Otherwise, it can be sold as a source of technical fatty acids. Those from chemical refining have higher values due to their higher tocopherol content. They are an attractive feedstock for the production of vitamin E. Due to the increasing interest in natural antioxidants, such as tocopherol, and the use of phytosterols in the food and pharmaceutical industry, the importance of this distillate will probably increase.

The types of solid/liquid output from different vegetable oil processing unit operations, are shown in Table 3.46.

	Degumming	Neutralisation	Bleaching	Deodorisation	Hardening
Solid/liquid output	Mucilage	Soapstock and spent acids/alkalis	Spent earth containing gums, metals and pigments	None	Spent catalysts and spent filtering aid

Table 3.46: Summary of key solid/liquid emissions and by-products in the manufacturing of crude vegetable oils
[10, Environment Agency of England and Wales, 2000, 74, Greek Ministry for the Environment, 2001]

A comparison between the solid output from olive oil production and seed oil production is given in Table 3.47.

Type of production	Raw material pretreatment	Conditioning of raw material	Pressing/ centrifugation	Solvent extraction
Waste from olives	Extraneous material, e.g. leaves and stones	None	Used filter cloths, pressed cake, olive stones	Extracted cake, meal and filter debris
Waste from oilseeds	Extraneous material, e.g. leaves and stones	None	Used filter cloths	None

Table 3.47: Summary of solid output from manufacturing crude vegetable oils
[10, Environment Agency of England and Wales, 2000, 185, CIAA-FEDIOL, 2004]

Types and quantities of wastes and by-products are summarised in Figure 3.10.

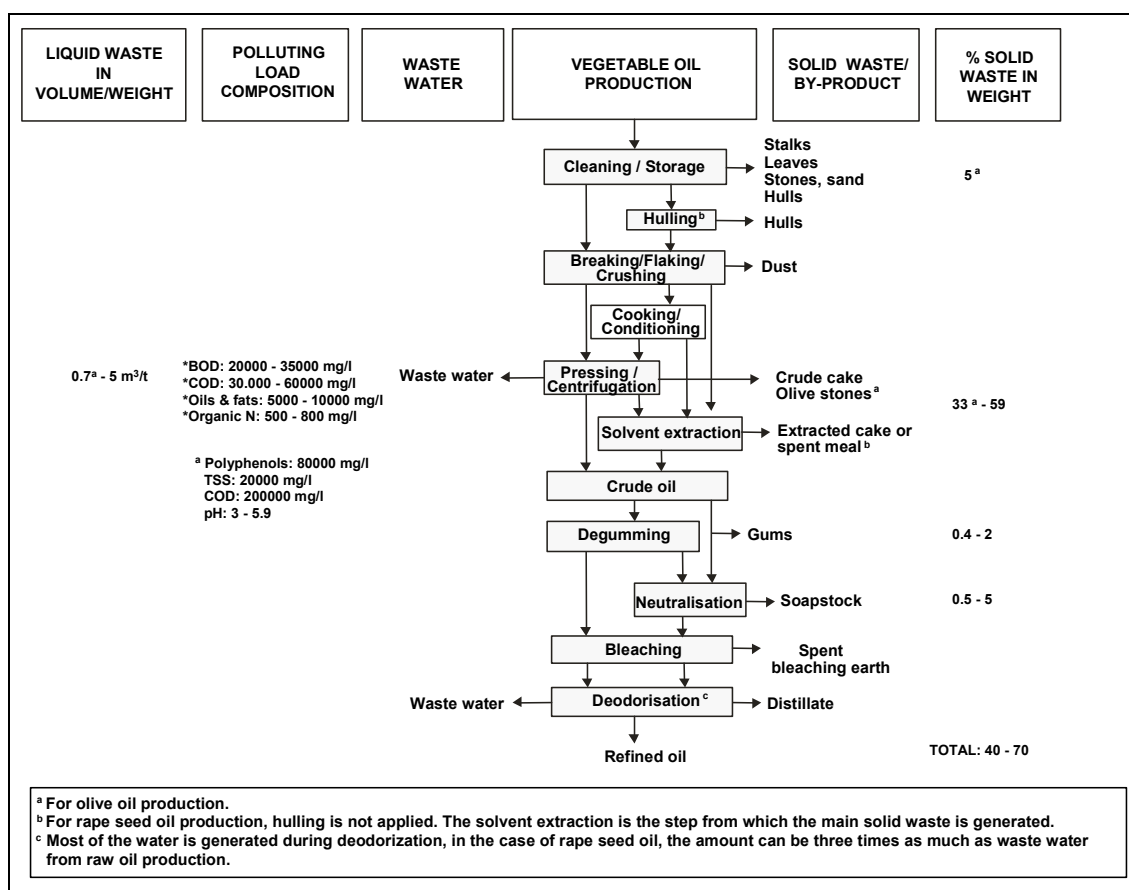

Figure 3.10: Types and quantities of wastes and by-products generated in vegetable oil processing [134, AWARENET, 2002]

3.3.4.4.1 Oilseed

Typically the yield from oilseed processing is almost 100 %. Products from oilseed processing and vegetable oil refining are mainly vegetable oil, protein rich meal, lecithin and ffa (acid oil). Ffa may contain tocopherol, a natural antioxidant. They can be used as a feedstock for the production of vitamin E. By-products may either be used as animal feed or burnt as fuels [182, Germany, 2003, 185, CIAA-FEDIOL, 2004].

Chemical refining produces soap stock during the neutralisation of crude oil. This consists mainly of the sodium salts of the separated ffa, but also includes triacylglycerols, phosphatides, proteins, pigments and other compounds. Normally soap stock is further processed in the refinery by splitting the soaps and regaining the ffa. It is possible to mix the soap stock from the chemical refining of vegetable oil with other ingredients to produce low quality soaps or for use in meal for animal feed [182, Germany, 2003, 185, CIAA-FEDIOL, 2004].

Crude cake and spent meal are either incinerated or used in the production of fuels and other products such as kernel oil and activated carbon. They can also be used in animal feed. Exhausted cake, which has an oil content lower than 1 %, is usually formed into pellets or briquettes and its main application is animal feed, but it may also be composted or burnt.

Lecithin is an edible by-product consisting of a mixture of phosphatides with minor quantities of glycolipids and oligosaccharides. It is known to have outstanding functional characteristics, such as emulsification properties, spreadability and wetting ability. After a very simple and inexpensive purification, it can be used in a number of applications in food, cosmetics and pharmaceuticals. Soybean oil is the most important source of lecithin, although other vegetable oils such as maize, sunflower or ground-nut oil also yield suitable lecithin.

In oilseed processing, 0.7 – 0.8 tonnes of solid output per tonnes of raw material are generated. The major part of it is of vegetable origin, e.g. cake and meal. This is either further treated to extract the residual oil content, which may be as high as 10 – 20 %, used in animal feed, sent for heat recovery, or used without or after composting as a soil conditioner.

3.3.4.4.2 Olive oil

In crude olive oil production, the traditional system, i.e. pressing, and the three-phase system produce a press cake and a considerable amount of waste water while the two-phase system, which is mainly used in Spain, produces a paste-like waste called “alperujo” that has a higher water content and is more difficult to treat than traditional solid waste. The water content of the press cake, composed of crude olive cake, pomace and husk, is about 30 % if it is produced by traditional pressing technology and about 45 – 50 % using decanter centrifuges. The press cake still has some oil that is normally recovered in a separate installation. The exhausted olive cake is incinerated or used as a soil conditioner on olive groves.

3.3.4.5 Energy

The energy consumption during the production of crude vegetable oil depends on the type of raw material, the equipment and the manufacturing processes. Heating, cooling, drying, milling, pressing, evaporation and distillation are the major energy consuming steps. Cold pressing, without heat conditioning of the raw material, which is especially used for olive oil production, needs twice as much energy as the pressing of heat conditioned oilseeds. Steam consumption is in the range 200 – 500 kg steam/t processed seed (155 – 390 kWh/t) and the electricity need is in the range 25 – 50 kWh/t processed seed (90 – 180 MJ/t) [109, CIAA-FEDIOL, 2002, 182, Germany, 2003, 185, CIAA-FEDIOL, 2004]. Table 3.48 shows energy and steam consumption for some processes in crude vegetable oil refining in German installations. Further energy consumption figures for some processes are given in techniques described in Sections 4.7.4.2, 4.7.4.3, and 4.7.4.4.

Processing step	Total energy consumption	Steam consumption ¹	Electricity Consumption
	(MJ/t final product)	(MJ/t final product)	(MJ/t final product)
Neutralisation	145 – 330	112 – 280	22 – 44
Soap splitting	620 – 2850*	560 – 2800*	11 – 36*
Deodorisation	510 – 1350	420 – 1120	60 – 150
Hardening	400 – 1000	n.d.	n.d.
Bleaching	n.d.	n.d.	n.d.
	(kWh/t final product)	(kWh/t final product)	(kWh/t final product)
Neutralisation	40 – 92	31 – 78	6 – 12
Soap splitting	172 – 792*	156 – 778*	3 – 10*
Deodorisation	142 – 375	117 – 311	17 – 42
Hardening	111 – 278	n.d.	n.d.
Bleaching	n.d.	n.d.	n.d.

¹ Calculated using 2.8 x kg steam/t = MJ/t
 *MJ/t soap or kWh/t soap
 n.d. (no data available)
 Final product = refined vegetable oil

Table 3.48: Energy consumption in crude vegetable oil refining [65, Germany, 2002, 109, CIAA-FEDIOL, 2002]

3.3.4.6 Chemicals used

Ideally, the extraction solvent should only dissolve glycerides and leave undesirable components such as colouring matter, gums, and phospholipids. The solvents must not contain toxic components, and should be recoverable with minimum loss, be safe in handling, and be readily removable from the extracted material. For these reasons, aliphatic hydrocarbons, especially hexane, are used almost exclusively. Technical hexane with a boiling point range of 55 – 70 °C has proved to be the optimum solvent. Hexane can be readily removed from the oil at temperatures below 100 °C under vacuum and can be stripped from the meal with steam. The solubility of hexane in the condensed water is only 0.1 %.

Alcohols like ethanol, isopropanol, methanol, butanol, and furfural are especially suited to the extraction of relatively wet materials. The extraction of oilseed with alcohols leads to relatively high concentrations of phosphatides, glycolipids, carbohydrates, and similar constituents in the crude oil, although the glycerides can, in principle, be concentrated by cooling or extraction of the alcoholic solutions. Alcohols are generally not used as primary extraction solvents. However, they are occasionally used as secondary extraction solvents to remove gossypol from cottonseed meal, thioglycosides from rapeseed meal, sugars from soybean meal (to produce protein concentrates), and alkaloids from bitter lupine meal. A new technology is oil supercritical propane or carbon dioxide extraction, where extraction takes place under high pressure. This process is reserved for special products of high intrinsic value because of the high equipment costs involved [87, Ullmann, 2001].

Chemicals are used in the chemical neutralisation of crude oil. 1 – 6 kg/t oil NaOH and 0.1 - 2 kg/t oil is used depending on the function of the type of oil and the ffa content of the pre-degummed or not, crude oil. If phosphoric acid is used, 0.1 – 2.0 kg/t oil is consumed. Alternatively, citric acid may also be used, its consumption is 0.1 – 1.0 kg/t oil. Sulphuric acid used in soap-stock splitting amounts to 100 – 250 kg H₂SO₄/t soap [109, CIAA-FEDIOL, 2002].

3.3.5 Dairy products

3.3.5.1 Water

3.3.5.1.1 Water consumption

Water consumption is mainly associated with cleaning operations. The factors affecting water consumption in European dairies are [160, European Dairy Association, 2002]:

- availability of surface and groundwater for cooling
- time and amount of water used for rinsing
- characteristics of CIP programmes
- maintenance, e.g. repair of leaks.

A reasonably efficient consumption of water is reported to be around 1 – 5 l/kg milk [134, AWARENET, 2002], however, it is reported that a water consumption of 0.8 – 1.0 l/kg milk can be achieved by using advanced equipment and a good operation [74, Greek Ministry for the Environment, 2001]. According to a German survey, 132 dairies used, on average in 1999, 2.06 l/kg of milk [39, Verband der Deutschen Milchwirtschaft (German Dairy Association), 2001]. Table 3.49 shows water consumption in European dairies. Table 3.50 shows water consumption for some Nordic dairies.

Product	Water consumption* (l/kg processed milk)	
	Min	Max
Market milk and yoghurt	0.8	25
Cheese and whey	1.0	60
Milk powder, cheese and/or liquid products	1.2	60

*Cooling water is included

Table 3.49: Water consumption in European dairies
[160, European Dairy Association, 2002]

Product	Water consumption (l/l processed milk)			
	Sweden	Denmark	Finland	Norway
Market milk and yoghurt	0.96 – 2.8 (8)	0.60 - 0.97 (3)	1.2 – 2.9 (8)	4.1 (1)
Cheese and whey	2.0 – 2.5 (4)	1.2 – 1.7 (5)	2.0 – 3.1 (2)	2.5 – 3.8 (2)
Milk powder, cheese and/or liquid products	1.7 – 4.0 (7)	0.69 – 1.9 (3)	1.4 – 4.6 (2)	4.6 – 6.3 (2)

Figures in brackets show the number of dairy installations in each category

Table 3.50: Water consumption for some Nordic dairies
[42, Nordic Council of Ministers, et al., 2001]

In the UK dairy industry, there is a wide variation in the water consumption/amount of milk processed ratio, compared to the volume of the milk received for processing per installation, as shown in Figure 3.11.

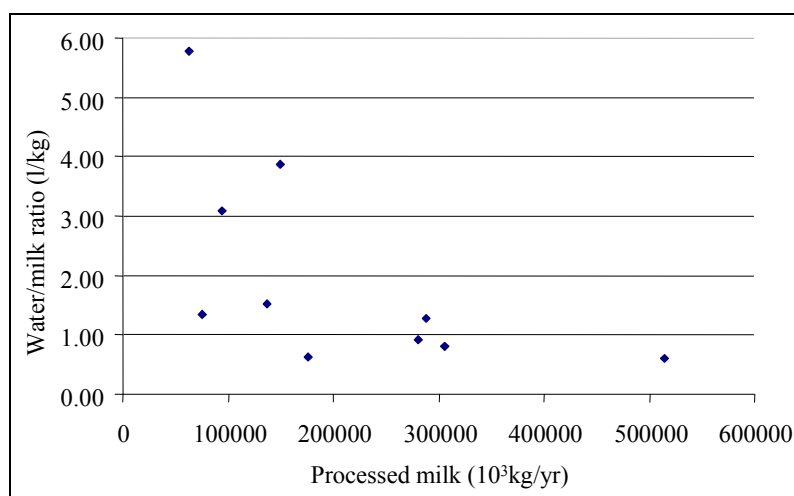

Figure 3.11: Water consumption/processed milk ratio as a function of the quantity of processed milk
[94, Environment Agency of England and Wales, 2002]

Seven ice-cream installations in Nordic countries have reported a water consumption in the range 3.6 – 10.3 l/kg of produced ice-cream [42, Nordic Council of Ministers, et al., 2001]. For ice-cream installations where no water recycling is applied in the cooling system, a water consumption of 10 – 325 l/kg of product has been reported [118, CIAA-EDA, 2002].

3.3.5.1.2 Waste water

Waste water is the main environmental issue in the dairy sector. The sector uses a vast amount of water, and generates a huge amount of waste water in maintaining the required level of hygiene and cleanliness. Data reported for specific waste water discharge for dairy activities in Austria are shown in Table 3.51. Waste water volume in a well managed installation is reported to be about 1 – 2 l/kg of milk processed.

Type of product	Waste water volume (l/kg of milk processed)
“White” products, e.g. milk, cream and yoghurt	3
“Yellow” products, e.g. butter and cheese	4
“Special” products, e.g. concentrates of milk or whey and dried milk products	5

Table 3.51: Approximate volumes of waste water in dairy activities [152, Austria, 2002]

In the UK, around 14 million m³ of milk is produced for processing each year. It is reported that a new dairy in the UK is achieving a 1:1 volume of milk processed:waste water volume ratio, i.e. one litre of waste water for each litre of milk processed and that a 1.5:1 ratio is achievable in existing dairies. A comparison is reported between a dairy generating 2 litres of waste water per litre of milk processed. This would produce around 28 million m³/year of waste water for disposal to a WWTP. If this waste water is considered to have an average COD strength of 3000 mg/l, then the total loading would be around 84000 t COD/yr, equivalent to the waste of more than two million people. Also, if 1 m³ of milk is released into a watercourse, its oxygen depleting potential, in terms of BOD₅ load, is equivalent to the daily raw sewage of 1500 – 2000 people.

Untreated dairy waste waters have an average BOD load ranging from 0.8 to 2.5 kg BOD/t milk. Other significant pollutants present in the waste water are phosphorus, nitrogen and chloride. Individual waste water streams of a wide pH range are produced. The temperature of the waste water streams may also need to be considered. The waste water may contain pathogens from contaminated materials or production processes [140, World Bank (IBRD), et al., 1998]. Table 3.52 gives data on the typical untreated waste water from dairy processing.

Component	Range
SS	24 – 5700 mg/l
TSS	135 – 8500 mg/l
COD	500 – 4500 mg/l**
BOD ₅	450 – 4790 mg/l
Protein	210 – 560 mg/l
Fat	35 – 500 mg/l
Carbohydrate	252 – 931 mg/l
Ammonia -N	10 – 100 mg/l**
Nitrogen	15 – 180 mg/l
Phosphorus	20 – 250** mg/l
Sodium	60 – 807 mg/l
Chloride	48 – 469 (up to 2000*) mg/l
Calcium	57 – 112 mg/l
Magnesium	22 – 49 mg/l
Potassium	11 – 160 mg/l
pH	5.3 – 9.4 (6 – 10*)
Temperature	12 – 40 °C
Actual levels will depend on the use of in-process techniques to prevent water contamination (not reported)	
* CIAA comments [83, CIAA, 2001]	
** German comments [99, Germany, 2002]	

Table 3.52: Reported untreated dairy waste water contamination levels [13, Environment Agency of England and Wales, 2000]

Volume and pollution levels of dairy waste water in Europe are shown in Table 3.53. The typical BOD of various milk products is shown in Table 3.54.

Product	Waste water volume (l/kg)	Parameters (mg/kg of processed milk)		
		COD	Total N	Total P
Market milk and yoghurt	0.9 – 25	2.0 – 10	0.05 – 0.14	0.01 – 0.02
Cheese	0.7 – 60	0.8 – 13	0.08 – 0.2	0.01 – 0.05
Milk and whey powder	0.4 – 60	0.5 – 6	0.03 – 0.3	0.01 – 0.2
Ice-cream	2.7 – 7.8			

Table 3.53: Volume and pollution levels of dairy waste water in Europe [42, Nordic Council of Ministers, et al., 2001, 160, European Dairy Association, 2002]

Product	BOD ₅ (mg/kg of product)
Whole milk	104000
Skimmed milk	67000
Double cream	399000
Yoghurt	91000
Ice-cream	292000
Whey	34000

Table 3.54: Typical BOD levels of various milk products [13, Environment Agency of England and Wales, 2000]

The largest proportion of waste water is cleaning water. This is used for equipment cleaning, e.g. line purging at product change-over, start-up, shut-down and change-over of HTST pasteurisation units as well as some product washing. Product loss during milk manufacture can be as high as 3 – 4 %, with normally 0.5 – 1.5 % of product being wasted. These milk losses can occur during cleaning; the run-off during the start-up, shut-down or change-over of an HTST unit; or from accidental spills. Product losses to waste water can contribute greatly to the COD, nitrogen and phosphorous content. Typical milk losses are shown in Figure 3.12.

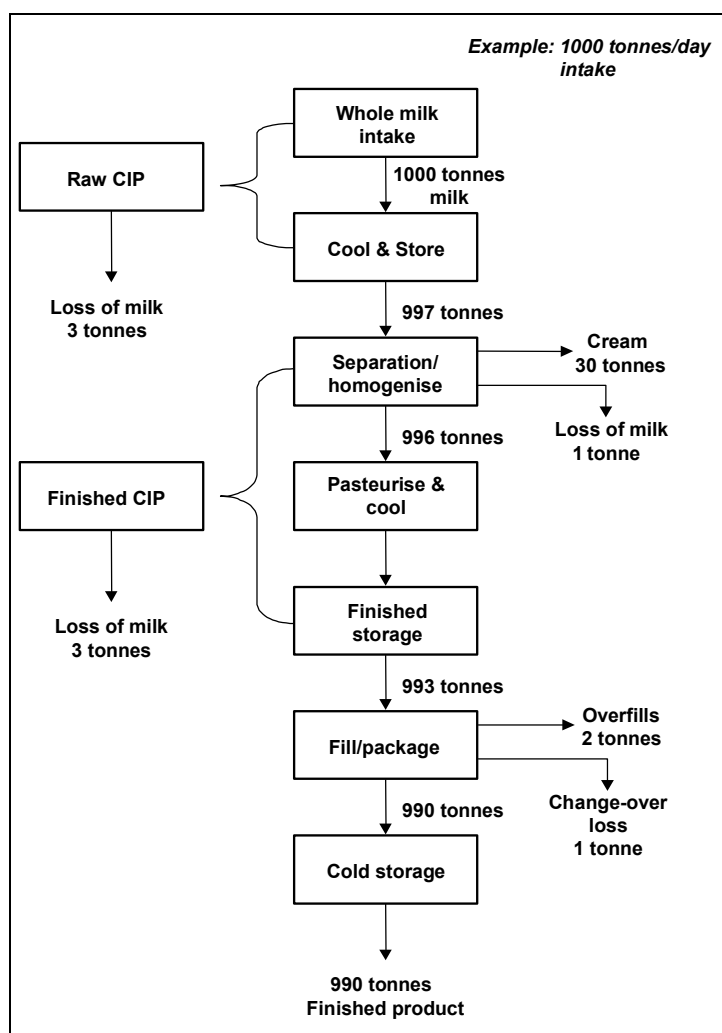

Figure 3.12: Typical losses of milk in the dairy industry
 [11, Environment Agency of England and Wales, 2000]

Although CIP operations contribute to saving water, energy and chemicals, they still generate large volumes of waste water, which may have a high or low pH due to the use of acid and alkaline cleaning solutions. The use of phosphoric and nitric acids will increase the phosphate and nitrate content of the waste water. Badly designed CIP systems and inadequate product removal prior to the start of the CIP cycle cause large quantities of product to enter the cleaning water. Some UK dairy sites have achieved a reduction of 40 – 65 % in their waste water COD as a result of improvements in this area [43, Envirowise (UK) and Entec UK Ltd., 1999]. Waste water with high concentrations of dissolved solids is produced by the regeneration of ion exchange resins and from membrane backwashing.

Large evaporators are used in the production of milk concentrate, which is the first stage in the production of milk powder, and dried whey. The evaporated water is condensed, giving rise to large quantities of condensate. Normally this is clean, but vacuum leaks on the condensers can lead to contamination with product. Condensate may be used in other processes, such as preheating incoming milk or as cleaning water after suitable treatment, e.g. RO followed by disinfection.

There are smaller contributions to the waste water from the non-dairy ingredients used in some of the products and from lubricants. SS are associated with coagulated milk, particles of cheese curd and non-dairy ingredients.

For cheese manufacturing, about 90 % of the milk used ends up as whey. Sweet whey is often recovered and used as a food grade additive. Salt whey, produced after salt has been added to the curd to remove additional liquid, is not suitable for this application unless the salt is removed by RO. The RO permeate is highly saline. Unless whey is processed quickly it becomes acidic due to lactic acid formation. If acid whey is discharged to a WWTP, it may cause low pH levels.

This waste water has an extremely variable composition, depending on the technology applied and whether whey is segregated. The characteristics of a typical waste water from cheese manufacturing are shown in Table 3.55.

Parameter	Installation with whey recovery	Installation without whey recovery
	mg/l	
BOD ₅	2397	5312
COD	5312	20559
Fats	96	463
N _{total}	90	159
P _{total}	26	21

Table 3.55: Composition of cheese manufacturing waste water
[134, AWARENET, 2002]

3.3.5.2 Air emissions

Many dairies produce thermal energy on site. Emissions of carbon dioxide, sulphur dioxide and nitrogen oxides derive from the energy production in the boiler plants and are not discussed here. Many dairies still use halogenated compounds in their cooling systems, mostly HCFCs, but small amounts of CFCs are still used in some countries. The interaction of halogen refrigerants with ozone in the air has resulted in the progressive prohibition of the placing on the market and use of ozone depleting substances and of products and equipment containing those substances [202, EC, 2000]. There is currently a proposal for a Regulation of the European Parliament and of the Council on certain fluorinated greenhouse gases [246, EC, 2003].

Ammonia used in cooling systems may leak or accidental releases may occur which also result in odour complaints. Odour problems are usually related to waste water treatment operations. Dairy installations situated in urban areas usually receive complaints regarding noise, e.g. associated with vehicle movements, refrigeration and UHT installations.

Bag filters can be used to reduce dust emissions to <5 mg/Nm³. Filters use significantly less energy than cyclones and produce less noise. If filtering installations suitable for CIP are used for outgoing air, it is not necessary to use cyclones allowing huge energy savings and noise reductions to be achieved. The filter powder of food quality can be used for other purposes.

3.3.5.3 Solid output

Packaging waste such as paper, wooden pallets, big bags and plastic films, and other wastes need to be re-used or disposed of. Wastes are also produced in fat traps, and in flotation and biological WWTPs. As well as these wastes, major solid or liquid wastes and by-products are also produced, e.g. whey residues, non-conforming products, sludge from separation during milk clarification and filtration, product loss on the heat transfer surface and discharged in the waste water during the cleaning of the equipment, curd waste, and small pieces of cheese. Whey may be segregated and processed to make further useful products. The non-conforming products are used as animal feed or sent for landfill and the sludge produced in the WWTP is sent for landfill.

Product losses in the dairy industry, expressed as a percentage of the volume of milk or fat or whey processed, are summarised in Table 3.56.

Type of processing	Product losses (%)		
	Milk	Fat	Whey
Butter/transport of skimmed milk	0.17	0.14	–
Butter and skimmed milk powder	0.60	0.20	–
Cheese	0.20	0.10	1.6
Cheese and whey evaporation	0.20	0.10	2.2
Cheese and whey powder	0.20	0.10	2.3
Consumer milk	1.9	0.7	–
Full-cream milk powder	0.64	0.22	–

Table 3.56: Product losses in some processes in the dairy industry
[140, World Bank (IBRD), et al., 1998]

Reported solid outputs per tonne of processed milk are shown in Table 3.57.

	Solid output (kg)	WWTP sludges
Liquid milk and yoghurt	1.7 – 45.0	0.2 – 18.0
Cheese	1 – 20	0.2 – 24
Milk and whey powder	0.5 – 16	3 – 30

Table 3.57: Solid output per tonne of processed milk
[160, European Dairy Association, 2002]

The main sources of wastes produced in milk, yoghurt and cheese processing are indicated in Figure 3.13, Figure 3.14, and Figure 3.15.

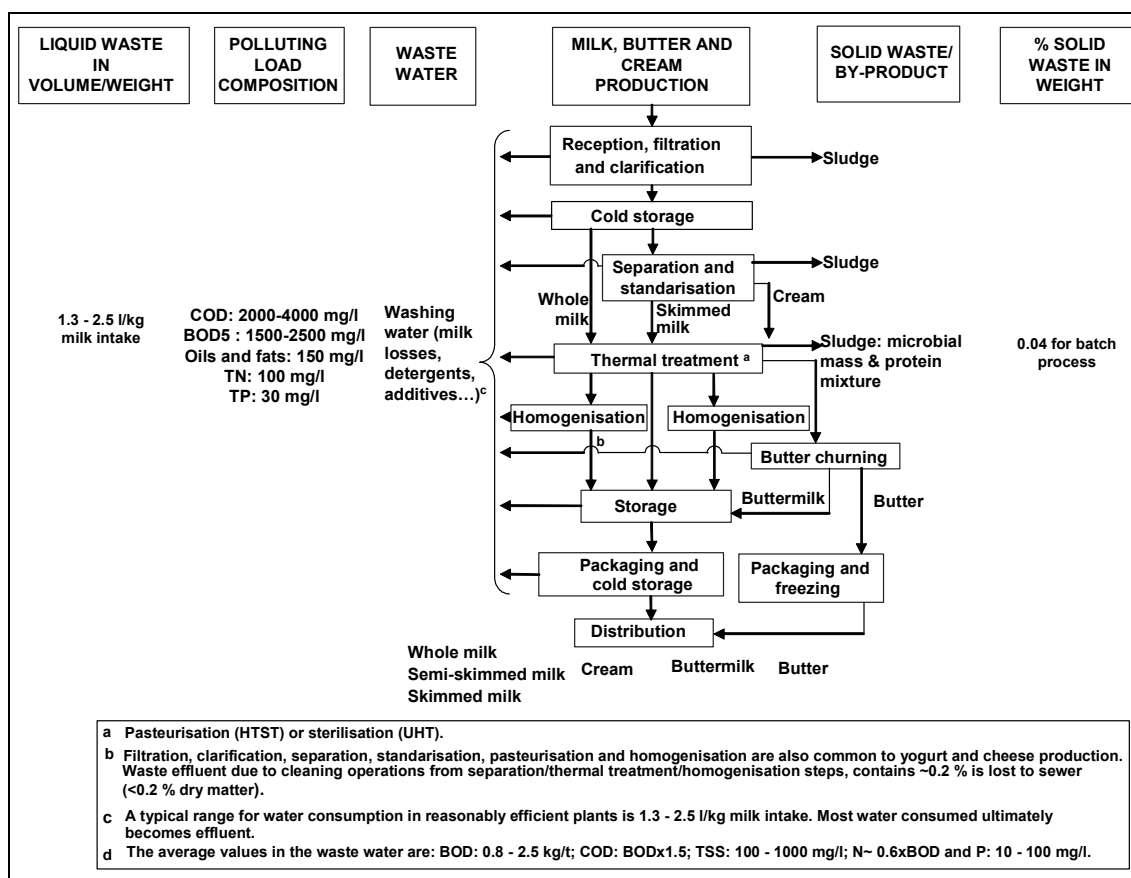

Figure 3.13: Type and amount of wastes produced in milk processing
[134, AWARENET, 2002]

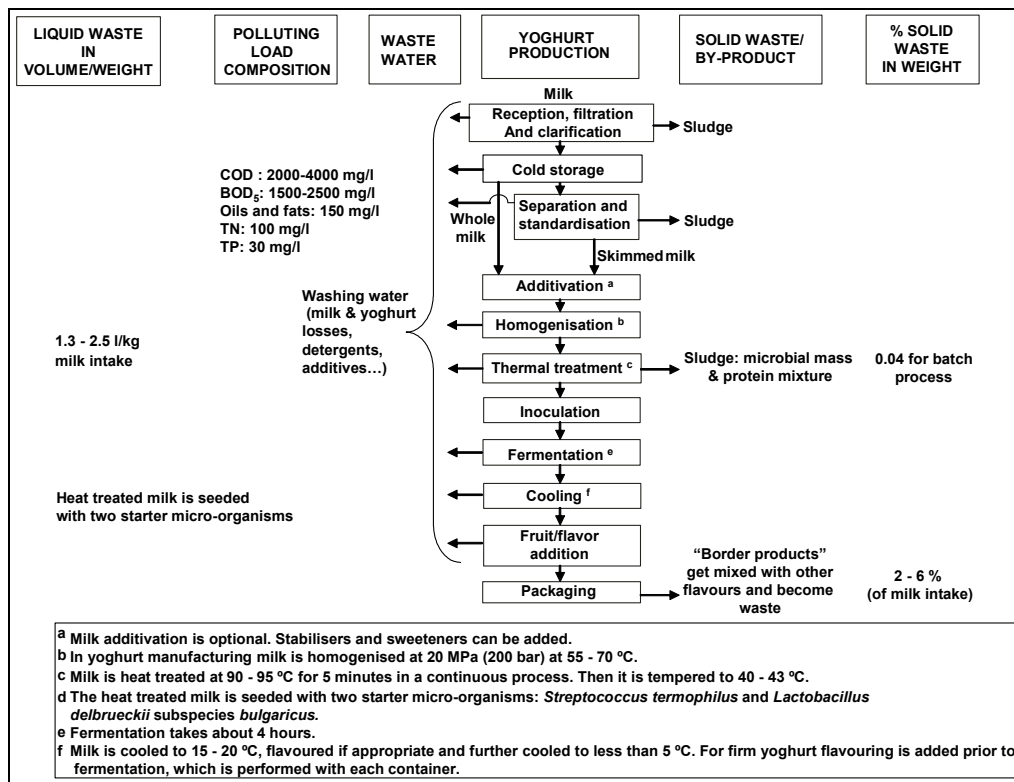

Figure 3.14: Type and amount of wastes produced in yoghurt processing [134, AWARENET, 2002]

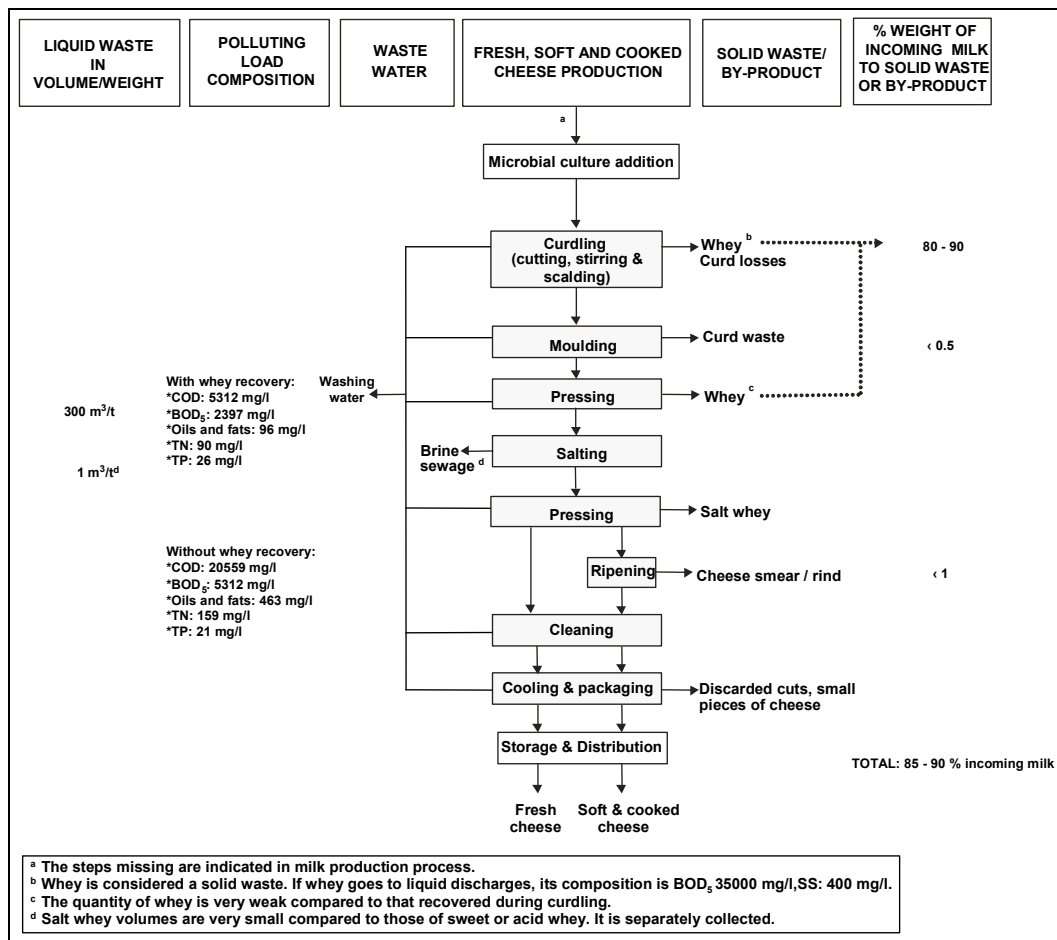

Figure 3.15: Type and amount of wastes produced in cheese processing [134, AWARENET, 2002]

Table 3.58 gives the reported total amounts of waste produced in Nordic dairy installations and their disposal. The figures do not include waste that is intended for animal feed. Non-conforming products sent for landfilling are included.

Products	Total solid waste (kg/1000 l)	Of which			
		Recycled	Incinerated	Composted	Sent for landfilling
Market milk, cultured products	1.7 – 14 (13)	5 – 41 %	0 – 48 %	0 – 14 %	14 – 95 %
Cheese, whey, powder	0.5 – 10 (17)	1 – 91 %	0 – 80 %	0 – 2 %	9 – 88 %
Ice-cream (kg/1000 kg)	35 – 48 (4)	4 – 33 %	0 – 6 %	0 %	67 – 95 %

* The figures in brackets show the number of dairy installations in each category

Table 3.58: Production and disposal of solid wastes from some Nordic dairies
[42, Nordic Council of Ministers, et al., 2001]

The overall solid output for ice cream manufacturing reported for Europe is in a wider range, i.e. 30 – 150 kg/t product [118, CIAA-EDA, 2002].

3.3.5.4 Energy

Dairies have a significant energy consumption. Around 80 % of the energy is consumed as thermal energy from the combustion of fossil fuels to generate steam and hot water. It is used for heating operations and cleaning. The remaining 20 % is consumed as electricity to drive machinery, refrigeration, ventilation, and lighting. The most energy consuming operations are the evaporation and drying of milk [42, Nordic Council of Ministers, et al., 2001]. In pasteurisation, e.g. significant energy is also needed for the heating and cooling steps. Recovery of heat by heat-exchangers can be applied. Evaporation is normally combined with vapour recompression. A wide range of energy consumption data has been reported for the European dairy industry. Figures are included in Table 3.59.

Products	Energy consumption (GJ/t processed milk)		Remarks
	Electricity	Fuel	
Market milk and yoghurt	0.15 – 2.5	0.18 – 1.5	Minimum for liquid milk, maximum for specialities
	0.09 – 1.11*		
Cheese	0.08 – 2.9	0.15 – 4.6	Depends on the type of cheese and production run. Maximum fuel for whey evaporation
	0.06 – 2.08*		
Milk and whey powder	0.06 – 3.3	3 – 20	Maximum fuel for whey products
	0.85 – 6.47*		

* approximate kWh/l (assuming milk has a density of 1 kg/l)

Table 3.59: Energy consumption in European dairies
[160, European Dairy Association, 2002]

Similar figures are reported for Nordic dairies, as shown in Table 3.60.

Products	Total energy consumption from electricity and fuel oil (kWh/l processed milk)			
	Sweden	Denmark	Finland	Norway
Market milk and cultured products	0.11 – 0.34 (8)*	0.07 – 0.09 (3)	0.16 – 0.28 (8)	0.45 (1)
Cheese and whey	0.15 – 0.34 (4)	0.12 – 0.18 (4)	0.27 – 0.82 (3)	0.21 (1)
Milk powder, cheese and/or liquid products	0.18 – 0.65 (7)	0.3 – 0.71 (3)	0.28 – 0.92 (2)	0.29 – 0.34 (2)

* Figures in brackets show the number of dairy installations in each category

Table 3.60: Total energy consumption for some Nordic dairies
[42, Nordic Council of Ministers, et al., 2001]

More energy is used in dairies where butter, as well as drinking milk, is produced and where the production of powdered milk is greater. Four installations of the ice-cream industry in Nordic countries have reported to have a total energy consumption in the range 0.75 - 1.6 kWh/kg of ice-cream produced [42, Nordic Council of Ministers, et al., 2001]. Other reports show an energy consumption of 2 – 10 GJ/t ice-cream produced [118, CIAA-EDA, 2002].

3.3.5.5 Consumption of chemicals

Most of the chemicals are used for the cleaning and disinfection of process machinery and pipelines. Fresh product dairies mainly use caustic and nitric acid and some disinfectants, such as hydrogen peroxide, peracetic acid and sodium hypochlorite. Disinfection agents are also used in a range of 0.01 – 0.34 kg/t processed milk [160, European Dairy Association, 2002]. Table 3.61 shows the consumption of cleaning agents used in European dairies. Of the total chemical consumption in Nordic dairies, 55 % is caustic and 30 % nitric acid. Table 3.62 shows the consumption of cleaning chemicals used in some Nordic dairies.

Products	Consumption of cleaning agents (kg/t processed milk)		
	NaOH, 100 %	HNO ₃ , 100 %	Detergents
Market milk and yoghurt	0.2 – 10	0.2 – 5.0	*
Cheese	0.4 – 5.4	0.6 – 3.8	0.1 – 1.5
Milk and whey powder	0.4 – 5.4	0.8 – 2.5	*

Values vary with the length and capacity of production runs
*Not applicable

Table 3.61 Consumption of cleaning agents used in European dairies
[160, European Dairy Association, 2002]

Product	Caustic as NaOH, 100 %	Nitric acid as HNO ₃ , 100 %
	kg/m ³ of processed milk or tonne of ice	
Market milk and yoghurt	0.2 – 0.9 (13)	0.1 – 1.0 (13)
Cheese/milk and whey powder	0.4 – 5.4 (14)	0.6 – 3.8 (14)
Ice-cream	0.5 – 4.5 (7)	0.2 – 2.5 (7)

Figures in brackets show the number of dairy installations in a category

Table 3.62: Consumption of cleaning chemicals used in some Nordic dairies
[42, Nordic Council of Ministers, et al., 2001]

Whey processing involving electro dialysis, ion exchange, ultra and nanofiltration, requires large amounts of phosphoric, sulphuric and hydrochloric acid as well as potassium hydroxide and sodium hypochlorite. Chelating agents are widely used in dairy cleaning operations and are discussed in Sections 4.3.8.2 to 4.3.8.2.5.

3.3.5.6 Noise

Noise is caused by the movement of milk tankers and distribution lorries; evaporators, spray driers, and cooling condensers [42, Nordic Council of Ministers, et al., 2001]. Bag filters use significantly less energy than cyclones and produce less noise. If filtering installations suitable for CIP are used for outgoing air, it is not necessary to use cyclones allowing huge energy savings and noise reductions to be achieved.

3.3.6 Dry pasta

The basic raw material for the production of high quality pasta products is semolina from durum wheat. 1.04 – 1.05 tonnes semolina are used to produce 1 tonne of pasta. Water and other ingredients are added to make a stiff dough containing approximately 31 % water. The dough is forced under pressure through dies of an extrusion auger. The major environmental issue in this sector is energy consumption as all pasta manufacturing processes involve drying.

3.3.6.1 Water

Water consumption is between 22 – 30 m³/t product. Water is mainly used as an ingredient. The production of process related polluted waste water is reported to be insignificant [117, CIAA-UNAFPA, 2002].

3.3.6.2 Emissions to air

Thermal energy is obtained in boilers generally using natural gas. Superheated water, of 130 - 160 °C and 4 – 7 bar as measured in a hydraulic air vessel, is used to dry pasta. Typical air emission values are shown in Table 3.63.

Parameter	Range
Carbon dioxide	130 – 160 kg CO ₂ /t product
Carbon monoxide	Lower than 100 mg/Nm ³ *
NO _x	Lower than 350 mg/Nm ³ *
* At 3 % O ₂ concentration	

Table 3.63: Air emissions from pasta manufacturing
[117, CIAA-UNAFPA, 2002, 150, Unione Industriali Pastai Italiani, 2002]

3.3.6.3 Energy

The drying step utilises about 85 – 90 % of the thermal energy and 50 – 60 % of the electricity consumption of the installation. These figures may even be higher for lines producing special products such as nests or lasagne. Air conditioning of the workspace needs 35 – 50 kWh/t energy.

In evaluating energy consumption in the sector, the results of a study on pasta factories with a production capacity of over 75 t/d led to the estimated consumption of electricity, expressed in kWh/t of product, and of thermal energy, expressed in kWh/t and MJ/t shown in Table 3.64.

Estimated energy consumption	Range
Electricity	140 - 220 kWh/t
Thermal energy (measured at the boiler)	0.417 – 0.527 kWh/t
	1.5 – 1.9 MJ/t

Table 3.64: Energy consumption in the Italian pasta industry
[117, CIAA-UNAFPA, 2002, 150, Unione Industriali Pastai Italiani, 2002]

3.3.7 Starch

Starch is manufactured from basically three major raw materials in Europe: maize, wheat and potatoes. The specific average consumptions are as follows: 1.85 tonnes of maize, 2.35 tonnes of wheat or 6.6 tonnes potatoes are used to produce 1 tonne starch [115, CIAA-AAC-UFE, 2002, 152, Austria, 2002].

3.3.7.1 Water consumption

Water consumption also depends on the starch and starch derived products produced on a particular site. The water consumption also differs according to the raw material used. Due to the higher water content of potatoes, the potato starch process requires less water than the cereal starch process. During the last 20 years, the starch industry has realised substantial savings, up to 20 %, in fresh water consumption through process integrating measures, internal recycling of process water and optimisation of the cooling water system. Nevertheless, due to product applications, e.g. food and pharmacy, and to quality requirements, process water recycling is not always possible. Table 3.65 shows the water consumption in the starch sector.

Raw material	Water consumption (m ³ /t raw material used)	
	Min	Max
Maize	1.7	3
Wheat	1.7	2.5
Potato	0.7	1.5

Table 3.65: Water consumption in the starch industry
[115, CIAA-AAC-UFE, 2002]

3.3.7.2 Waste water

Specific waste water discharge from starch production in Austria is at 1.4 m³/t of processed potato, i.e. average of a processing campaign, 1.8 m³/t of processed maize, i.e. yearly average, and 2.0 m³/t of processed wheat, i.e. yearly average [152, Austria, 2002].

3.3.7.3 Air emissions

Dust emission from starch driers is between 10 – 80 mg/Nm³ [115, CIAA-AAC-UFE, 2002].

3.3.7.4 Solid output

There are many factors that affect the amount of sludge after waste water treatment. It is reported that the type and the efficiency of the manufacturing process used is the most important. Also, practically no sludge is generated if there is anaerobic waste water treatment before discharging to the MWWTP. Some by-products, e.g. gluten produced in starch manufacturing, can be used in other food or animal feed processes, or sent for landspreading. Table 3.66 shows the solid outputs from the starch industry.

Parameter	Solid output (kg/t raw material used)	
	Min	Max
Stones*	1	10*
Soil	8	60*
Organic matters	0.5	4
Sand*	1.5	7*
Waste water sludge**	0	3
*The highest values are for potato processing		
**Data are expressed in dry substance		

Table 3.66: Solid outputs from the starch industry
[115, CIAA-AAC-UFE, 2002]

3.3.7.5 Energy

The energy consumption depends on the starch and starch derived products produced on the site, i.e. on the techniques and processes involved in the starch production and co-products management. However, the main use of energy in starch production is thermal energy for the evaporation and drying processes. The energy used to produce starch slurry is low in comparison to the final production of dry products. More energy is consumed at sites where evaporation and/or drying processes are used for co-products such as fibre, solubles and proteins than at sites where solubles are landspread and fibre is sold as wet cattle feed. The general consumption of energy in the starch sector is given in the Table 3.67.

Energy	Raw material	Min	Max
	(kWh/t raw material used)		
Electrical energy	Maize	100	200
	Wheat	200	500
	Potato	40	80
Thermal energy	Maize	200	500
	Wheat	800	1300
	Potato	50	250

Table 3.67: Energy consumption in the starch industry
[115, CIAA-AAC-UFE, 2002]

3.3.8 Sugar

Most of the information in this sector comes from the “Guide to Establishing BAT in the Sugar Industry; Comité Européen des Fabricants de Sucre (June 2001)” [61, CEFS, 2001], unless otherwise stated.

3.3.8.1 Sugar beet

3.3.8.1.1 Water consumption

The water requirement for fluming is about 500 – 800 % of the amount of beet. For washing, 150 – 200 % is needed, and for a single stone catcher 70 – 100 % water is needed based on the amount of beet. The mechanically clarified water is re-used for fluming and washing, thus only 25 – 30 % beet based industrial water needs to be added during the last rinsing of the beets after washing.

Smaller losses are caused by evaporation of the cooling water and by discharging by-products and wastes containing water. However, the root body consists of about 75 – 78 % water, therefore, the beets carry sufficient water into the processing, which accumulates as condensate. Thus, an installation producing sugar is a net water producer, because the water contained initially in the beet becomes available as surplus cooling water [134, AWARENET, 2002].

While the overall water used is about 15 m³/t sugar beet processed, the consumption of fresh water is 0.25 – 0.4 m³/t sugar beet processed, or even less in modern sugar factories. Water consumption depends on the activities of each installation, e.g. more water is consumed in an installation that extracts and refines sugar beet, than one that does only one of those activities. In Austria, the consumption of water is of 1.5 m³/t of sugar beet processed, equivalent to 9 m³/t produced sugar, was reported [152, Austria, 2002]. Table 3.69 shows the water consumption in Danish sugar factories.

Parameter	Specific value per tonne of beet processed		Specific value per tonne of sugar produced	
	Average	Range	Average	Range
Water (m ³)	0.37	0.23 ^a – 0.50 ^b	2.39	1.56 ^a – 3.21 ^b
^a Excluding cooling water (two factories)				
^b Including cooling water (two factories)				

Table 3.68: Water consumption in Danish sugar factories
[139, Nielsen E.H. Lehmann, 2002]

3.3.8.1.2 Waste water

Sugar beet is 75 % water, and the extraction process, by definition, aims to release a high proportion of water contained in the beets. Approximately half of this water is lost due to evaporation or inclusion in various product streams. The remainder is, after usage for washing and fluming, a source of high strength waste water.

The beets are floated through the cleaning stage where stones, weeds and other gross contaminants are removed. The transport water pumped off with the soil sludge can be up to 70 % of the beet. It has a high organic contamination due to the soil and sugar from damaged beets. Its COD is 5000 – 20000 mg/l.

The beets then enter the installation, where they are washed before being sliced into cosettes to maximise the surface area for the extraction process. The condensate from the evaporation and crystallisation stages is partly used as process water in several process stages, including beet washing. Process waste water is deemed to be the excess condensate from the concentration and crystallisation stages. This surplus condensate is high in ammonia and relatively low in COD content. Waste water with high BOD levels is produced in large volumes [13, Environment Agency of England and Wales, 2000] and is cleaned in a WWTP.

3.3.8.1.3 Solid output

During the reception and fluming of the sugar beet, soil, stones, sand and vegetable matter, e.g. seeds, beet tails and leaves, are removed. The amount of the earth adhering to the beet may vary greatly depending on, e.g. the weather conditions during harvesting and the design and operation of the harvester. In the annual processing of 500000 tonnes of beets, an average of 60000 tonnes of soil accumulates [87, Ullmann, 2001]. The soil arriving at the installation is removed in settling ponds. The sediment may be re-applied to arable land or may be used for other purposes, such as horticulture or civil engineering works. The vegetable matter is separated from the fluming water for sale as animal feed or fertiliser.

The sugar content of the beets does not vary greatly, e.g. 18.4 % in Austria and 13.9 % in Greece [87, Ullmann, 2001]. The efficiency of sugar extraction is about 90 %. There are other substances either in the wastes or by-products, such as beet pulp. After sugar is taken out, the extracted beet pulp is pressed. The wet pulp may then be dried. Beet pulp is normally sold as sweet feed for cattle. Another by-product is carbonation lime. Juice purification is done using lime. It may be pressed and sold to de-acidify or balance the pH of soil.

Sugar beets contain some soluble non-sugar substances, 30–40 % of which are eliminated during purification of the juice with Ca^{2+} precipitable anions, pectins and proteins. The remainder is left in the juice and prevents the complete crystallisation of the sugar, leaving a final syrup, called molasses. This is the major single loss of sugar in the process. 10–18 % of the sugar content of the beet is in molasses. About 38 kg molasses per tonne of sugar beet is generated. Molasses is about 80 % solid material and 20 % water.

In a study of Danish sugar factories, approximately 49 % of the total production was reported to be primary products such as sugar, molasses and feed pills. While the remaining by-products such as lime, beet pulp and weeds were sold or re-used [139, Nielsen E.H. Lehmann, 2002].

Figure 3.16 shows a typical process flow diagram for a sugar beet processing installation and the production of waste water, wastes and by-products [134, AWARENET, 2002].

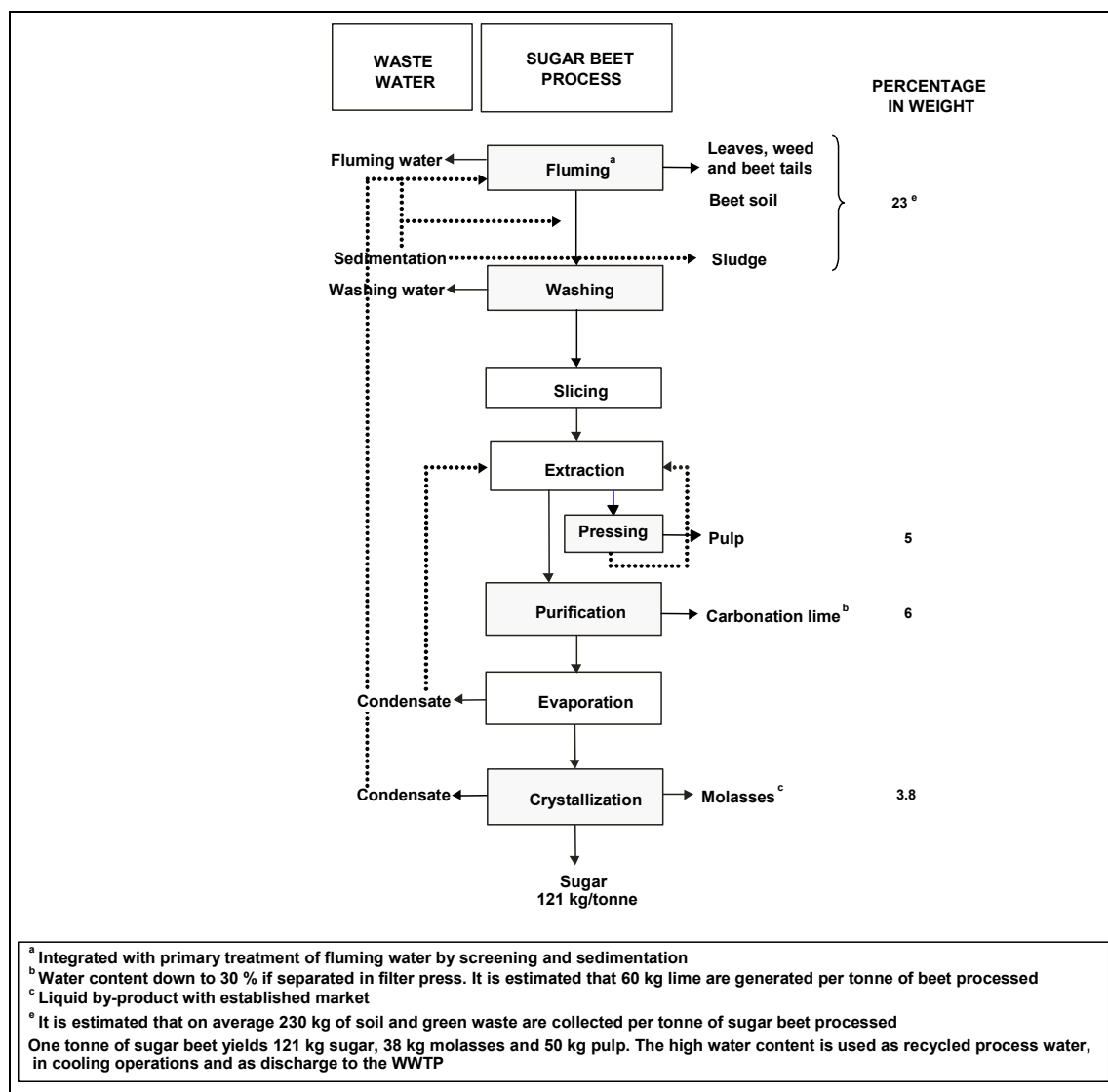

Figure 3.16: Type and amount of waste water, wastes and by-products from sugar beet processing [134, AWARENET, 2002]

3.3.8.1.4 Energy

Significant thermal energy is consumed for the evaporation and beet pulp drying. Electrical energy is needed for the pumps and for driving the centrifuges. According to CEFS, specific energy consumption was 31.49 kWh/100 kg beet in 1998 [159, CIAA-CEFS, 2003]. Table 3.69 shows the energy consumption in Danish sugar factories.

Total energy (kWh) consumed			
Specific value per tonne of beet processed		Specific value per tonne of sugar produced	
Average	Range	Average	Range
307	232 – 367	1987	1554 – 2379

Table 3.69: Energy consumption in Danish sugar factories
[139, Nielsen E.H. Lehmann, 2002]

In a Greek study, a figure of 280 kWh/t is given for the electrical part of the energy consumption in sugar manufacturing [74, Greek Ministry for the Environment, 2001].

3.3.8.2 Cane sugar refining

The starting point is not sugar cane, but raw sugar, therefore less water is required than in sugar beet processing. The regeneration every 40 – 50 hours of the ion exchange resin cells used in the decolourisation process generates a difficult waste water as caustic brine is used as the regenerant [13, Environment Agency of England and Wales, 2000]. There may be excess condensate and sweet water although these can be eliminated (see Section 4.7.7.3). Waste water is generated from the steam cleaning of the bulk road tankers used to transport liquid sugar products.

3.3.9 Coffee

See extraction in Section 3.2.9, roasting in Section 3.2.39 and drying in Section 3.2.44.

3.3.10 Drinks

This section includes the production of ethyl alcohol by fermentation, manufacture of wine from grapes and from concentrated grape must, manufacture of fruit wines and other fermented fruit drinks, manufacture of cider and perry, manufacture of distilled alcoholic drinks, manufacture of soft drinks, and production of mineral waters, if this is carried out together with another activity covered by IPPC Directive. The manufacture of fruit juices and beer are discussed in Sections 3.3.3 and 3.3.11.

3.3.10.1 Water consumption

Water consumption is in the range of 6 – 14 m³/m³ product. In breweries, water is mainly used for mashing, heat transfer and cleaning operations. Water consumption for modern breweries generally ranges from 0.4 – 1 m³/hl.

3.3.10.2 Waste water

The major issue in this sector is waste water generation. Some typical waste water production figures for the soft drinks sector are shown in Table 3.70.

Product	Specific waste water discharge (m ³ /m ³ of product)
Bottled waters	0.8
Fruit juices	1.5
Carbonates/dilutables	1.4
Carbonates/fruit juices	3.6

Table 3.70: Average specific waste water discharges
[51, Envirowise (UK), 1998]

Processes for the manufacture of different drinks have common sources of waste water, including the following:

- cleaning of installation and equipment, and of containers, e.g. bottles, cans and casks
- pasteurisation of food in containers
- floor cleaning
- once-through cooling water or bleed from closed-circuit cooling systems
- boiler blowdown
- backwash from water treatment systems
- “chase” water purged from pipework between uses.

The preparation and cleaning of equipment is the largest source of waste water in this sector. The cleaning of fermenter vessels in particular is a major source of COD/BOD load and SS. Proprietary products used in the cleaning process, e.g. clay, disinfectants, detergents and disinfection agents, contribute to the waste water loadings. Dilute solutions of peracetic acid, a widely used disinfection agent, have a COD of approximately 1000 mg/l. An example installation from this sector changed the lubricant they used on their conveyors and reduced soap usage by 75 %. This led to a substantial COD reduction from discharges associated with the soap. In addition to these point sources, overflowing vessels and tanks often make a significant contribution to the waste water strength.

3.3.10.2.1 Wine

Waste water is generated in nearly all process steps, e.g. cleaning of containers, reactors and filters. The highest concentrated waste water is produced during fermentation, fining and ageing/racking due to the washing out of the sediments, marcs and lees. The semi-solid fractions can be separated for further dewatering, drying, processing or disposal rather than being washed with water, due to their high organic load. If solids from fining and racking are not separated, the waste water is highly contaminated and has extremely high BOD values of up to 500000 mg/l. Therefore, it is essential to recover the waste water components at source by filtration, centrifugation or sedimentation, so that they do not enter the WWTP. Wine bottles are cleaned before filling, and consequently washing water enters the WWTP or is recycled.

Even after the recovery process, the waste water shows an acidic character (pH 4 – 6) except when caustic solutions are used in the elimination of tartrate or during the conditioning of bottles. The most polluting waste water during wine production is generated during the fermentation and racking (especially first racking) operations. Average waste water composition is shown in Table 3.71.

	Fermentation			Ageing/racking			Barrel cleaning
	Cellar 1	Cellar 2	Cellar 3	Cellar 1	Cellar 2	Cellar 3	
pH	4.86	4.61	6.17	3.71	3.90	3.70	4.30
Conductivity ($\mu\text{S}/\text{cm}$)	893	641	531	1452	1377	1938	863
COD (mgO_2/l)	5249	2286	5925	22428	16210	66986	2401
TSS (mg/l)	444	452	205	4700	4490	31700	18
TKN (mgN/l)	51.5	40.9	35.9	239	279	1288	51.8
N-NH ₄ ⁺ (mgN/l)	7.86	7.28	13.1	34.3	33.1	154	11.2
P-PO ₄ ³⁻ (mg/l)	13.6	10.6	10.6	21.2	26.6	101	1.10
BOD ₅ (mgO_2/l)	3000	1900	3000	6000	9000	42500	1250

Table 3.71: Waste water characteristics in processes of a red winery
[134, AWARENET, 2002]

3.3.10.2.2 Cider and perry

The major sources of waste water are the cooling water system, which serves the condensers and fermentation tanks, and the residues (vinasses) from the distillation towers. There are two main processes which generate waste water in cider and perry manufacturing installations, i.e. the production of the final product from juice, and the milling of fruit.

The production of the final product occurs all year round, whereas the milling of fruit is dictated by the harvesting of the fruit. Waste water from the production of the final product is generally generated from cleaning water; waste product, which is kept to a minimum and spillages from storage areas. During the milling season, the waste water volumes and strengths increase significantly. The main sources of waste water during this period are transport water used in conveying the fruit through the process, surplus evaporator water from juice concentrating, and general cleaning water.

The transport water can often be recycled, however, this waste water is highly polluted. Towards the middle of the milling season, flows and loads increase due to the quantity of fruit entering an installation. Towards the end of the milling season the volume of waste water decreases, however, the BOD and solids content of the waste water increases due to the deteriorating quality of the fruit being received.

3.3.11 Brewing

Beer is a fermented drink with a relatively low alcohol content made from various types of malt and grain. Malted barley predominates but malted wheat, maize or other grains, or sugar and syrups may also be used. Although there are installations where malt is also produced at the same premises, consumption and emission levels for malt production are reported in Section 3.2.26.

Breweries use significant amounts of water and energy and produce waste water and solid residues. Figure 3.17 shows the typical consumption and emission levels for German breweries. Note that capacity/output of breweries is usually expressed in hectolitres (hl) not in cubic metres (m³) of beer.

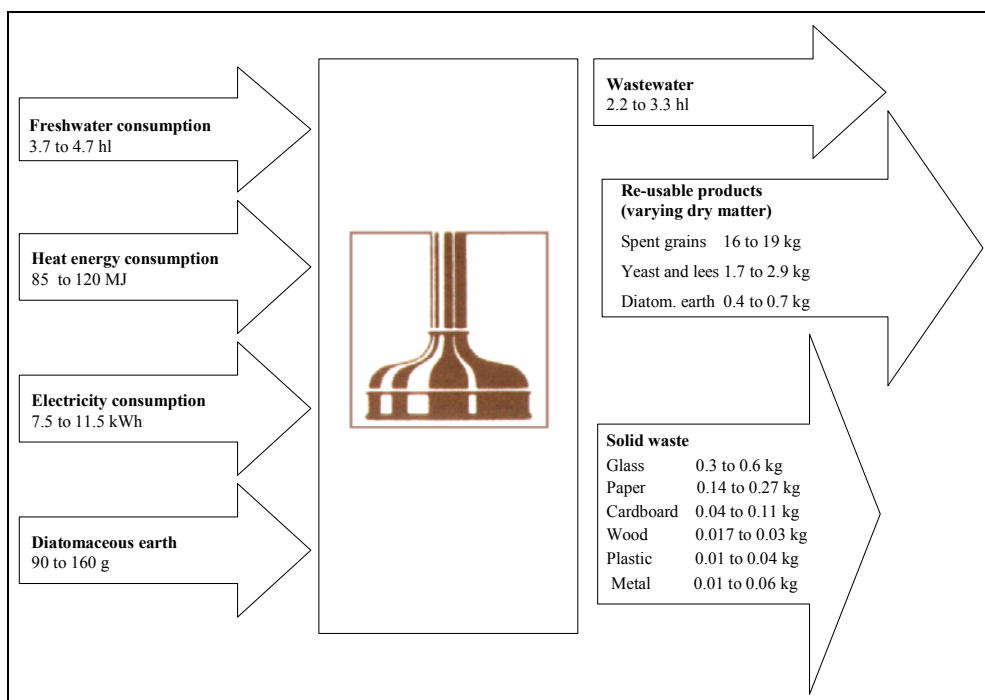

Figure 3.17: Input and output figures for large German breweries (capacity over 1 million hl beer) per hl of beer sold [65, Germany, 2002]

3.3.11.1 Water consumption

Water consumption for modern breweries generally ranges from 0.4 to 1 m³/hl of beer produced. An example Finnish brewery reported an average water consumption of 0.32 m³/hl [199, Finland, 2003]. Water consumptions for individual process stages, as reported for the German brewing industry, are shown in Table 3.72.

Department	Specific water consumption (m ³ /hl beer produced)			
	Measured**		Literature	
	from	to	from	to
Brewhouse	0.130	0.236	0.174	0.26
Cold storage			0.11	0.24
Fermentation cellar	0.032	0.053	0.04	0.08
Storage cellar	0.024	0.067	0.01	0.06
Filtering cellar	0.031	0.109	0.01	0.076
Bottling cellar	0.059	0.163	0.09	0.098
Cask cellar	0.013	0.061	0.01	0.12
Miscellaneous*	0.20	0.204	0.026	0.397
TOTAL PROCESS	0.489	0.893	0.470	1.331
*Estimates				
**Measurements by Heidemann, Rosenwinkel and Seyfried (1990 to 1992) or brewery figures				

Table 3.72: Water consumption for different brewery processes [65, Germany, 2002]

The water consumption figure varies depending on the type of beer, the number of beer brands, the size of brews, the existence of a bottle washer, how the beer is packaged and pasteurised, the age of the installation, the system used for cleaning and the type of equipment used. If an on-site well is used, the water may require treatment before use, during which losses of up to 30 % may occur. Bottling consumes more water than kegging. Consumption levels are high for once through cooling systems and/or losses due to evaporation in hot climates.

3.3.11.2 Waste water

The waste water discharge is equal to the water supply minus the produced beer, the evaporated water in the brewery and utility plants, and the water present in the by-products and solid waste. It is reported that in Austria 0.26 – 0.6 m³ of waste water is produced per hectolitre of beer. It is reported that in modern breweries 0.3 – 0.9 m³ of waste water is produced per hectolitre of beer. An example Finnish brewery reported an average waste water production of 0.24 m³/hl [199, Finland, 2003]. Table 3.73 shows waste water production in different brewing processes.

Department	Specific waste water volume (m ³ /hl beer produced)			
	Measured*		Literature	
	from	to	from	to
Brewhouse/cold storage	0.024	0.063	0.010 0.008	0.114 0.050
Fermentation cellar	0.005	0.021	0.0012	0.070
Storage cellar	0.005	0.013	0.0014	0.030
Filtering cellar	0.019	0.059	0.0070	0.090
Bottling cellar	0.036	0.068	0.070	0.280
Cask cellar	0.008	0.037	0.0053	0.067
Miscellaneous	0.020	0.204	-	-
Total process	0.117	0.465	0.1029	0.701
* Measurements by Heidemann, Rosenwinkel and Seyfried (1990 – 1992)				

Table 3.73: Waste water production in different brewery processes [65, Germany, 2002]

The waste water is very variable and the pollution load of the different steps do not follow the volumes throughput, e.g. bottle cleaning produces a high amount of waste water but with only a low organic load, while waste water from fermentation and filtering account for only about 3 % of the total waste water volume but 97 % of the BOD load [140, World Bank (IBRD), et al., 1998]. Organic pollution in waste water mainly comes from the following sources:

- brewers grains
- yeast and surplus yeast
- trub
- weak wort discharge
- emptying and rinsing of water from kettles
- emptying of process tanks
- pre- and after-runs from diatomaceous earth filtration and filling
- chase water from process pipes
- rejected beer in the packaging area
- returned beer
- breakage of bottles in the packaging area
- ancillary materials used in the packaging area
- conveyor lubrication
- label glue.

SS in the waste water originate from the discharge of by-products, diatomaceous earth, e.g. kieselguhr, and possible label pulp from the bottle cleaner. Nitrogen originates mainly from detergents used for tank cleaning, from the malt and from additives. Phosphorus may come from the cleaning agents used. Large variations in pH may occur due to the use of acids and caustic for the cleaning of process equipment and returnable bottles. Heavy metals are normally present in very low concentrations. Wear of the machines, especially conveyors in packaging lines, may be sources of nickel and chromium. Table 3.74 shows the characteristics of untreated waste water from breweries. In terms of pollution load, Table 3.75 shows the ranges valid for modern breweries.

Parameter	Unit	Range
BOD ₅	mg/l	1000 – 1500
COD	mg/l	1800 – 3000
Suspended solids	mg/l	10 – 60
Total nitrogen	mg/l	30 – 100
Total phosphorus	mg/l	30 – 100
pH	–	3 – 13

Table 3.74: Untreated waste water characteristics for breweries [65, Germany, 2002, 136, CBMC - The Brewers of Europe, 2002, 140, World Bank (IBRD), et al., 1998]

Parameter	Unit	Range
Water consumption	hl water/hl beer sold	4 – 10
Waste water generation	hl water/hl beer sold less water consumption	1.3 – 1.8
COD	kg/hl beer sold	0.8 – 2.5
COD/BOD ₅ ratio	–	1.5 – 1.7
Total suspended solids	kg/hl beer sold	0.2 – 0.4

Table 3.75: Waste water and pollution generated in breweries [136, CBMC - The Brewers of Europe, 2002]

3.3.11.3 Air emissions

Apart from the emissions to air from energy generation processes, the main potential emission sources are dust from material intake and transport of raw materials, i.e. grains, and filtration aids, i.e. kieselguhr. Ammonia from cooling operations may be accidentally released.

The largest source of odour emissions is the evaporation from wort boiling. Other sources are waste water treatment, storage and handling of co-products and by-products, oil storage, ventilation of beer cellars and packaging lines and air emissions from the boiler house.

3.3.11.4 Solid output

Solid materials enter the brewery in the form of raw and ancillary materials. Solid materials leave the brewery as co-products such as brewers grains and surplus yeast, primary and secondary packaging material, and other solid waste. Generally, only a very small amount of hazardous waste is produced, e.g. spent laboratory chemicals and batteries. Major co-product, by-product and solid waste fractions are identified in the example shown in Figure 3.18. The generation of co-product, by-product and solid waste is quantified for a brewery that produces one million hectolitres of beer per year. The example installation produces beer bottled mainly in returnable bottles, and uses plastic crates. The generation of flue-gas and waste water treatment residuals are not considered.

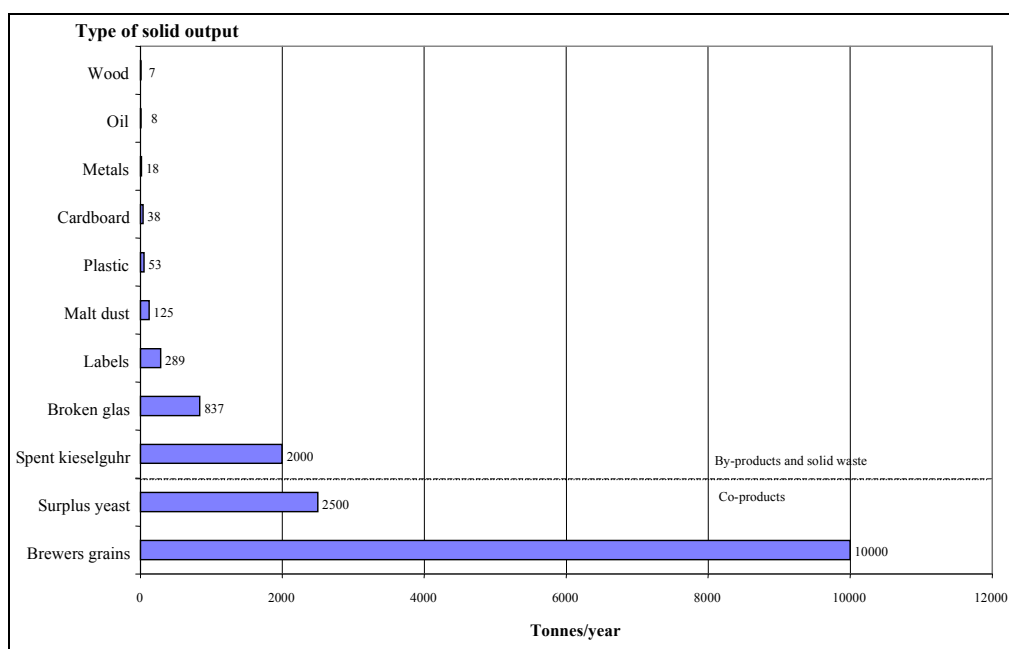

Figure 3.18: Co-product, by-product and solid waste quantities from a 1 million hl beer/yr brewery [136, CBMC - The Brewers of Europe, 2002]

Husk and malt grits may be mixed into brewers grains which are used in the production process. Surplus yeast, brewers grains, trub from the whirlpool and husk and malt grits may be used as animal feed. Yeasts are also used in cosmetics, pharmaceuticals and spreads. Spent diatomaceous earth, i.e. kieselguhr, can be used in the cement industry, broken glass may be re-used for glass manufacturing. Label pulp from cleaning the returnable bottles, cardboard and paper wastes may be re-used in the paper industry. Plastics and metal from hop cans and replacement equipment may be recycled.

3.3.11.5 Energy

Breweries need both electrical and heat energy. Combined heat and power generation is in use in some facilities. Depending on availability, price and legal requirements, different fuels such as coal, oil or gas are used. Table 3.76 gives average energy consumption levels for German breweries with 20 or more employees.

Year	Heat				Electrical Power	Beer Output	Specific	
	Coal	Oil	Gas	Total			Heat	Power
	(x 10 ⁶ kWh)				(x 10 ⁶ kWh)	(x 10 ⁶ hl)	(kWh/hl)	(kWh/hl)
1997	157	929	2992	4078	1199	114.8	35.5	10.4
1998	150	846	2943	3939	1187	111.7	35.3	10.6
1999	162	789	2956	3907	1175	112.8	34.6	10.4
2000	150	683	2809	3642	1163	110.4	33.0	10.5
	(x 10 ⁶ MJ)				(MJ/hl)			
1997	565	3345	10771	14681			127.9	
1998	541	3046	10595	14182			127.0	
1999	583	2841	10642	14066			124.7	
2000	540	2458	10113	13111			118.7	

Table 3.76: Energy consumption of German breweries with more than 20 employees [65, Germany, 2002]

A brewery without a sophisticated heat recovery system consumes about 27.78 – 55.55 kWh/hl beer (100 - 200 MJ/hl) [136, CBMC - The Brewers of Europe, 2002]. The main heat consuming process steps are mashing, wort boiling, generation of hot liquor, CIP, sterilising, bottle/keg cleaning and pasteurising. Heat consumption for some departments is given in Table 3.77.

Department/ process	Minimum	Mean	Maximum	Literature ¹	Measured ²
	figure			range	
	(MJ/hl beer)			(MJ/hl beer)	
Brewhouse	87	92	121	84 – 113	50 – 80
Bottling installation	58	86	94	25 – 46	38 – 58
Kegging installation	8	11	13	8 – 13	
Process water	3	4	8	4 – 8	
Service water				8 – 17	
Miscellaneous				33 – 46	95
Total	156	193	236	162 – 243	183 – 233
	(kWh/hl beer)			(kWh/hl beer)	
Brewhouse	24.17	25.56	33.61	23.33 – 31.39	13.89 – 22.22
Bottling installation	16.11	23.89	26.11	6.94 – 12.78	10.56 – 16.11
Kegging installation	2.22	3.06	3.61	2.22 – 3.61	
Process water	0.83	1.11	2.22	1.11 – 2.22	
Service water				2.22 – 4.72	
Miscellaneous				9.17 – 12.78	26.39
Total	43.33	53.62	65.55	44.99 – 67.50	24.44 – 64.72
¹⁾ 20000 to 500000 hl beer sold/yr					
²⁾ 300000 to 500000 hl beer sold/yr					

Table 3.77: Heat consumption for different brewery processes [65, Germany, 2002]

The major consumers of electrical energy are the packaging area; cooling plant; compressed air plant; if applied, the carbon dioxide recovery plant; WWTP and air conditioning. Pumps, ventilators, drives, and electric lighting count for a large part of the electricity consumption, with about 8 – 12 kWh/hl in a brewery.

3.3.11.6 Noise

The main noise sources are transport within the brewery with lorries and forklifts, condensers and cooling towers.

3.3.11.7 Solid output

The majority of solid waste arises from packaging.

3.3.12 Citric acid

The process is described in Section 2.2.20. The major environmental issues are water pollution and the generation of solid wastes.

3.3.12.1 Water consumption

Specific water consumption is around 40 m³ per tonne of installation citric acid production capacity.

3.3.12.2 Waste water

The waste water generated has high COD levels; compounds containing calcium and sulphur derived from precipitation and decomposition, and a high concentration of NH₄-N from the raw material (molasses) and fermentation [151, Austrian contribution, 2002].

3.3.12.3 Solid output

The main solid wastes are the mycelium of the mould filtered from the fermentation broth, the gypsum generated during citric acid purification and the solid wastes produced during waste water treatment, i.e. anaerobic sludge and sulphur from biogas. Minor quantities of filtering aids are derived from polishing filtration. The solid wastes and by-products from citric acid fermentation are shown in Table 3.78.

Solid waste and by-product	Unit	Value
Mycelium	kg dry	100
Gypsum (CaSO ₄ x 2H ₂ O)	matter/ t citric acid	1000
Waste water sludge from anaerobic pretreatment		50
Sulphur from desulphurisation		3 – 4

Table 3.78: Solid wastes and by-products in the citric acid fermentation process [151, Austrian contribution, 2002]

4 TECHNIQUES TO CONSIDER IN THE DETERMINATION OF BAT

This chapter sets out techniques considered generally to have potential for achieving a high level of environmental protection in the industries within the scope of the document. Management systems, process-integrated techniques and end-of-pipe measures are included, but a certain amount of overlap exists between these three when seeking the optimum results.

Prevention, control, minimisation and recycling procedures are considered as well as the re-use of materials and energy.

Techniques may be presented singly or as combinations to achieve the objectives of IPPC. Annex IV to the Directive lists a number of general considerations to be taken into account when determining BAT and techniques within this chapter will address one or more of these considerations. As far as possible a standard structure is used to outline each technique, to enable comparison of techniques and an objective assessment against the definition of BAT given in the Directive.

The content of this chapter is not an exhaustive list of techniques and others may exist or be developed which may be equally valid within the framework of BAT.

Generally, a standard structure is used to outline each technique, as shown in Table 4.1.

Type of information considered	Type of information included
Description	Technical description of the technique
Achieved environmental benefits	Main environmental impact(s) to be addressed by the technique (process or abatement), including emission values achieved (normally a range) and efficiency performance. Environmental benefits of the technique in comparison with others.
Cross-media effects	Any side-effects and disadvantages to other media caused by its implementation. Environmental problems of the technique in comparison with others.
Operational data	Performance data on emissions/wastes and consumption (raw materials, water and energy). Any other useful information on how to operate, maintain and control the technique, including safety aspects and operability constraints of the technique, output, quality, etc.
Applicability	Consideration of the factors involved in applying and retrofitting the technique (e.g. space availability, process specific).
Economics	Information on costs (investment and operation) and any possible savings (e.g. reduced raw material consumption, waste charges), preferably related to the capacity of the technique.
Driving force for implementation	Reasons for implementation of the technique (e.g. other legislation, improvement in product quality)
Example installations	Reference to installations where the technique is reported to be used
Reference literature	Literature source for more detailed information on the technique.

Table 4.1: Format of information about techniques for consideration in the determination of BAT

In this document, some end-of-pipe techniques have been included in this chapter, whether or not they are considered in the determination of BAT, e.g. in Sections 4.4 and 4.5.

The techniques described show that prevention can be achieved in many ways, such as using production techniques that pollute less than others; reducing material inputs; re-engineering the processes to re-use products, which, e.g. have not met the customer's specification; improving management practices and substituting substances with less hazardous ones. This chapter provides information on some both general and specific pollution prevention and control techniques that have been implemented on an industrial scale.

The “Storage BREF” [95, EC, 2005] covers general storage and handling techniques so these are generally not included in this document, unless they are related to FDM-specific issues such as food safety and shelf-life.

The FDM sector is so diverse that it is impossible to describe every technique that can be considered in the determination of BAT for every activity and under every circumstance. It is, however, evident that there are various good techniques used in one part of the sector that are also applicable in others.

This chapter is divided into seven main sections, as follows:

Section 4.1 General techniques for the FDM sector

This section describes techniques that are generally applicable across the FDM sector, but not in any particular unit operation. Some apply to overall management and control of installations, e.g. providing training and others can be applied in a variety of unit operations, e.g. level measurement.

Section 4.2 Techniques applicable in a number of FDM sectors

This section describes techniques that can be applied to individual unit operations which are applicable in some FDM sectors but not in others. The techniques are presented in the same order as the unit operations and their current consumption and emission levels are described in Chapters 2 and 3 respectively.

Section 4.3 Cleaning

Hygiene is a very important priority in the FDM sector because it affects product safety, quality and shelf-life and consequently the prevention of wasted ingredients and FDM products. Techniques are described which acknowledge the requirement for cleaning to be carried out frequently and effectively, but with the aim of minimising its environmental impact.

Section 4.4 Techniques for minimising air emissions

Techniques to reduce emissions to air are described in this section. Many of the techniques described are end-of-pipe measures to reduce emissions not prevented by the application of in-process technological and operational techniques.

Section 4.5 End-of-pipe waste water treatment

All FDM installations produce waste water and many have an on-site WWTP, which either partially treats the waste water before it is sent off site for further treatment, or treats it for re-use on site or for direct discharge to the environment. General waste water treatment techniques are described in the first part of this section and information about waste water treatment in some specific sectors is given in the second part.

Section 4.6 Prevention of accidents

This section describes techniques for identifying, assessing and controlling the risks of accidents and minimising their environmental impact if they occur.

Section 4.7 Techniques applicable in some individual sectors

This section describes techniques under the headings of the sectors where they are known to be applicable. The techniques are presented in the same order as information about specific sectors in Chapters 2 and 3.

Care has been taken to ensure that the techniques described do not conflict with the requirements of relevant food safety legislation.

4.1 General techniques for the FDM sector

4.1.1 Environmental management tools

Description

The best environmental performance is usually achieved by the installation of the best technology and its operation in the most effective and efficient manner. This is recognised by the IPPC Directive definition of “techniques” as “*both the technology used and the way in which the installation is designed, built, maintained, operated and decommissioned*”.

For IPPC installations, an Environmental Management System (EMS) is a tool that operators can use to address these design, construction, maintenance, operation and decommissioning issues in a systematic, demonstrable way. An EMS includes the organisational structure, responsibilities, practices, procedures, processes and resources for developing, implementing, maintaining, reviewing and monitoring the environmental policy. Environmental Management Systems are most effective and efficient where they form an inherent part of the overall management and operation of an installation.

Within the European Union, many organisations have decided on a voluntary basis to implement environmental management systems based on EN ISO 14001:1996 or the EU Eco-management and audit scheme EMAS. EMAS includes the management system requirements of EN ISO 14001, but places additional emphasis on legal compliance, environmental performance and employee involvement; it also requires external verification of the management system and validation of a public environmental statement (in EN ISO 14001, self-declaration is an alternative to external verification). There are also many organisations that have decided to put in place non-standardised EMSs.

While both standardised systems (EN ISO 14001:1996 and EMAS) and non-standardised (“customised”) systems in principle take the *organisation* as the entity, this document takes a more narrow approach, not including all activities of the organisation e.g. with regard to their products and services, due to the fact that the regulated entity under the IPPC Directive is the *installation* (as defined in Article 2).

An environmental management system (EMS) for an IPPC installation can contain the following components:

- (a) definition of an environmental policy
- (b) planning and establishing objectives and targets
- (c) implementation and operation of procedures
- (d) checking and corrective action
- (e) management review
- (f) preparation of a regular environmental statement
- (g) validation by certification body or external EMS verifier
- (h) design considerations for end-of-life installation decommissioning
- (i) development of cleaner technologies
- (j) benchmarking.

These features are explained in somewhat greater detail below. For detailed information on components (a) to (g), which are all included in EMAS, the reader is referred to the reference literature indicated below.

(a) Definition of an environmental policy

Top management are responsible for defining an environmental policy for an installation and ensuring that it:

- is appropriate to the nature, scale and environmental impacts of the activities
- includes a commitment to pollution prevention and control
- includes a commitment to comply with all relevant applicable environmental legislation and regulations, and with other requirements to which the organisation subscribes
- provides the framework for setting and reviewing environmental objectives and targets
- is documented and communicated to all employees
- is available to the public and all interested parties.

(b) Planning, i.e.:

- procedures to identify the environmental aspects of the installation, to determine those activities which have or can have significant impacts on the environment, and to keep this information up-to-date
- procedures to identify and have access to legal and other requirements to which the organisation subscribes and that are applicable to the environmental aspects of its activities
- establishing and reviewing documented environmental objectives and targets, taking into consideration the legal and other requirements and the views of interested parties
- establishing and regularly updating an environmental management programme, including designation of responsibility for achieving objectives and targets at each relevant function and level as well as the means and timeframe by which they are to be achieved.

(c) Implementation and operation of procedures

It is important to have systems in place to ensure that procedures are known, understood and complied with, therefore effective environmental management includes:

(i) Structure and responsibility

- defining, documenting and communicating roles, responsibilities and authorities, which includes appointing one specific management representative
- providing resources essential to the implementation and control of the environmental management system, including human resources and specialised skills, technology and financial resources.

(ii) Training, awareness and competence

- identifying training needs to ensure that all personnel whose work may significantly affect the environmental impacts of the activity have received appropriate training.

(iii) Communication

- establishing and maintaining procedures for internal communication between the various levels and functions of the installation, as well as procedures that foster a dialogue with external interested parties and procedures for receiving, documenting and, where reasonable, responding to relevant communication from external interested parties.

(iv) Employee involvement

- involving employees in the process aimed at achieving a high level of environmental performance by applying appropriate forms of participation such as the suggestion-book system or project-based group works or environmental committees.

(v) Documentation

- establishing and maintaining up-to-date information, in paper or electronic form, to describe the core elements of the management system and their interaction and to provide direction to related documentation.

- (vi) Efficient process control
 - adequate control of processes under all modes of operation, i.e. preparation, start-up, routine operation, shut-down and abnormal conditions
 - identifying the key performance indicators and methods for measuring and controlling these parameters (e.g. flow, pressure, temperature, composition and quantity)
 - documenting and analysing abnormal operating conditions to identify the root causes and then addressing these to ensure that events do not recur (this can be facilitated by a ‘no-blame’ culture where the identification of causes is more important than apportioning blame to individuals).
 - (vii) Maintenance programme
 - establishing a structured programme for maintenance based on technical descriptions of the equipment, norms etc. as well as any equipment failures and consequences
 - supporting the maintenance programme by appropriate record keeping systems and diagnostic testing
 - clearly allocating responsibility for the planning and execution of maintenance.
 - (viii) Emergency preparedness and response
 - establishing and maintaining procedures to identify the potential for and response to accidents and emergency situations, and for preventing and mitigating the environmental impacts that may be associated with them.
- (d) Checking and corrective action, i.e.:
- (i) Monitoring and measurement
 - establishing and maintaining documented procedures to monitor and measure, on a regular basis, the key characteristics of operations and activities that can have a significant impact on the environment, including the recording of information for tracking performance, relevant operational controls and conformance with the installation's environmental objectives and targets (*see also the Reference document on Monitoring of Emissions*)
 - establishing and maintaining a documented procedure for periodically evaluating compliance with relevant environmental legislation and regulations.
 - (ii) Corrective and preventive action
 - establishing and maintaining procedures for defining responsibility and authority for handling and investigating non-conformance with permit conditions, other legal requirements as well as objectives and targets, taking action to mitigate any impacts caused and for initiating and completing corrective and preventive action that are appropriate to the magnitude of the problem and commensurate with the environmental impact encountered.
 - (iii) Records
 - establishing and maintaining procedures for the identification, maintenance and disposition of legible, identifiable and traceable environmental records, including training records and the results of audits and reviews.
 - (iv) Audit
 - establishing and maintaining (a) programme(s) and procedures for periodic environmental management system audits that include discussions with personnel, inspection of operating conditions and equipment and reviewing of records and documentation and that results in a written report, to be carried out impartially and objectively by employees (internal audits) or external parties (external audits), covering the audit scope, frequency and methodologies, as well as the responsibilities and requirements for conducting audits and reporting results, to determine whether or not the environmental management system conforms to planned arrangements and has been properly implemented and maintained

- completing the audit or audit cycle, as appropriate, at intervals of no longer than three years, depending on the nature, scale and complexity of the activities, the significance of associated environmental impacts, the importance and urgency of the problems detected by previous audits and the history of environmental problems – more complex activities with a more significant environmental impact are audited more frequently
- having appropriate mechanisms in place to ensure that the audit results are followed up.

(v) Periodic evaluation of legal compliance

- reviewing compliance with the applicable environmental legislation and the conditions of the environmental permit(s) held by the installation
- documentation of the evaluation.

(e) Management review, i.e.:

- reviewing, by top management, at intervals that it determines, the environmental management system, to ensure its continuing suitability, adequacy and effectiveness
- ensuring that the necessary information is collected to allow management to carry out this evaluation
- documentation of the review.

(f) Preparation of a regular environmental statement:

- preparing an environmental statement that pays particular attention to the results achieved by the installation against its environmental objectives and targets. It is regularly produced – from once a year to less frequently depending on the significance of emissions, waste generation etc. It considers the information needs of relevant interested parties and it is publicly available (e.g. in electronic publications, libraries etc.).

When producing a statement, the operator may use relevant existing environmental performance indicators, making sure that the indicators chosen:

- i. give an accurate appraisal of the installation's performance
- ii. are understandable and unambiguous
- iii. allow for year on year comparison to assess the development of the environmental performance of the installation
- iv. allow for comparison with sector, national or regional benchmarks as appropriate
- v. allow for comparison with regulatory requirements as appropriate.

(g) Validation by certification body or external EMS verifier:

- having the management system, audit procedure and environmental statement examined and validated by an accredited certification body or an external EMS verifier can, if carried out properly, enhance the credibility of the system.

(h) Design considerations for end-of-life plant decommissioning

- giving consideration to the environmental impact from the eventual decommissioning of the unit at the stage of designing a new plant, as forethought makes decommissioning easier, cleaner and cheaper
- decommissioning poses environmental risks for the contamination of land (and groundwater) and generates large quantities of solid waste. Preventive techniques are process-specific but general considerations may include:
 - i. avoiding underground structures
 - ii. incorporating features that facilitate dismantling
 - iii. choosing surface finishes that are easily decontaminated
 - iv. using an equipment configuration that minimises trapped chemicals and facilitates drain-down or washing
 - v. designing flexible, self-contained units that enable phased closure

vi. using biodegradable and recyclable materials where possible.

(i) Development of cleaner technologies:

- environmental protection should be an inherent feature of any process design activities carried out by the operator, since techniques incorporated at the earliest possible design stage are both more effective and cheaper. Giving consideration to the development of cleaner technologies can for instance occur through RandD activities or studies. As an alternative to internal activities, arrangements can be made to keep abreast with – and where appropriate – commission work by other operators or research institutes active in the relevant field.

(j) Benchmarking, i.e.:

- carrying out systematic and regular comparisons with sector, national or regional benchmarks, including for energy efficiency and energy conservation activities, choice of input materials, emissions to air and discharges to water (using for example the European Pollutant Emission Register, EPER), consumption of water and generation of waste.

Standardised and non-standardised EMSs

An EMS can take the form of a standardised or non-standardised (“customised”) system. Implementation and adherence to an internationally accepted standardised system such as EN ISO 14001:1996 can give higher credibility to the EMS, especially when subject to a properly performed external verification. EMAS provides additional credibility due to the interaction with the public through the environmental statement and the mechanism to ensure compliance with the applicable environmental legislation. However, non-standardised systems can in principle be equally effective provided that they are properly designed and implemented.

Achieved environmental benefits

Implementation of and adherence to an EMS focuses the attention of the operator on the environmental performance of the installation. In particular, the maintenance of and compliance with clear operating procedures for both normal and abnormal situations and the associated lines of responsibility should ensure that the installation’s permit conditions and other environmental targets and objectives are met at all times.

Environmental management systems typically ensure the continuous improvement of the environmental performance of the installation. The poorer the starting point is, the more significant short-term improvements can be expected. If the installation already has a good overall environmental performance, the system helps the operator to maintain the high performance level.

Cross-media effects

Environmental management techniques are designed to address the overall environmental impact, which is consistent with the integrated approach of the IPPC Directive.

Operational data

No specific information reported.

Applicability

The components described above can typically be applied to all IPPC installations. The scope (e.g. level of detail) and nature of the EMS (e.g. standardised or non-standardised) will generally be related to the nature, scale and complexity of the installation, and the range of environmental impacts it may have.

Economics

It is difficult to accurately determine the costs and economic benefits of introducing and maintaining a good EMS. A number of studies are presented below. However, these are just examples and their results are not entirely coherent. They might not be representative for all sectors across the EU and should thus be treated with caution.

A Swedish study carried out in 1999 surveyed all 360 ISO-certified and EMAS-registered companies in Sweden. With a response rate of 50 %, it concluded among other things that:

- the expenses for introducing and operating EMS are high but not unreasonably so, save in the case of very small companies. Expenses are expected to decrease in the future
- a higher degree of co-ordination and integration of EMS with other management systems is seen as a possible way to decrease costs
- half of all the environmental objectives and targets give payback within one year through cost savings and/or increased revenue
- the largest cost savings were made through decreased expenditure on energy, waste treatment and raw materials
- most of the companies think that their position on the market has been strengthened through the EMS. One-third of the companies report increasing revenue due to EMS.

In some MSs reduced supervision fees are charged if the installation has a certification.

A number of studies¹ show that there is an inverse relationship between company size and the cost of implementing an EMS. A similar inverse relationship exists for the payback period of invested capital. Both elements imply a less favourable cost-benefit relationship for implementing an EMS in SMEs compared to larger companies.

According to a Swiss study, the average cost for building and operating ISO 14001 can vary:

- for a company with between 1 and 49 employees: CHF 64000 (EUR 44000) for building the EMS and CHF 16000 (EUR 11000) per year for operating it
- for an industrial site with more than 250 employees: CHF 367000 (EUR 252000) for building the EMS and CHF 155000 (EUR 106000) per year for operating it.

These average figures do not necessarily represent the actual cost for a given industrial site because this cost is also highly dependent on the number of significant items (pollutants, energy consumption, ...) and on the complexity of the problems to be studied.

A recent German study (Schaltegger, Stefan and Wagner, Marcus, *Umweltmanagement in deutschen Unternehmen - der aktuelle Stand der Praxis*, February 2002, p. 106) shows the following costs for EMAS for different branches. It can be noted that these figures are much lower than those of the Swiss study quoted above. This is a confirmation of the difficulty to determine the costs of an EMS.

Costs for building (EUR):

minimum - 18750
maximum - 75000
average - 50000

Costs for validation (EUR):

minimum- 5000
maximum- 12500
average - 6000

A study by the German Institute of Entrepreneurs (Unternehmerinstitut/Arbeitsgemeinschaft Selbständiger Unternehmer UNI/ASU, 1997, *Umweltmanagementbefragung - Öko-Audit in der mittelständischen Praxis - Evaluierung und Ansätze für eine Effizienzsteigerung von Umweltmanagementsystemen in der Praxis*, Bonn.) gives information about the average savings achieved for EMAS per year and the average payback time. For example, for implementation

¹ E.g. Dyllick and Hamschmidt (2000, 73) quoted in Klemisch H. and R. Holger, *Umweltmanagementsysteme in kleinen und mittleren Unternehmen – Befunde bisheriger Umsetzung*, KNI Papers 01/02, January 2002, p 15; Clausen J., M. Keil and M. Jungwirth, *The State of EMAS in the EU. Eco-Management as a Tool for Sustainable Development – Literature Study*, Institute for Ecological Economy Research (Berlin) and Ecologic – Institute for International and European Environmental Policy (Berlin), 2002, p 15.

costs of EUR 80000 they found average savings of EUR 50000 per year, corresponding to a payback time of about one and a half years.

External costs relating to verification of the system can be estimated from guidance issued by the International Accreditation Forum (<http://www.iaf.nu>).

Driving forces for implementation

Environmental management systems can provide a number of advantages, e.g.

- improved insight into the environmental aspects of the company
- improved basis for decision-making
- improved motivation of personnel
- additional opportunities for operational cost reduction and product quality improvement
- improved environmental performance
- improved company image
- reduced liability, insurance and non-compliance costs
- increased attractiveness for employees, customers and investors
- increased trust of regulators, which could lead to reduced regulatory oversight
- improved relationship with environmental groups.

Example plants

The features described under (a) to (e) above are elements of EN ISO 14001:1996 and the European Community Eco-Management and Audit Scheme (EMAS), whereas the features (f) and (g) are specific to EMAS. These two standardised systems are applied in a number of IPPC installations. As an example, there are 342 EMAS registered organisations within the EU FDM sector. **THIS NEEDS TO BE UPDATED BEFORE IEF**

In the UK, the Environment Agency of England and Wales carried out a survey among IPC (the precursor to IPPC) regulated installations in 2001. It showed that 32 % of respondents were certified to ISO 14001 (corresponding to 21 % of all IPC installations) and 7 % were EMAS registered. All cement works in the UK (around 20) are certified to ISO 14001 and the majority are EMAS registered. In Ireland, where the establishment of an EMS (not necessarily of a standardised nature) is required in IPC licenses, an estimated 100 out of approximately 500 licensed installations have established an EMS according to ISO 14001, with the other 400 installations having opted for a non-standardised EMS.

Reference literature

(Regulation (EC) No 761/2001 of the European parliament and of the council allowing voluntary participation by organisations in a Community eco-management and audit scheme (EMAS), OJ L 114, 24/4/2001, http://europa.eu.int/comm/environment/emas/index_en.htm)

(EN ISO 14001:1996, <http://www.iso.ch/iso/en/iso9000-14000/iso14000/iso14000index.html>; <http://www.tc207.org>)

4.1.2 Optimise operation by providing training

Description

Giving staff at all levels, from management to shop floor, the necessary training and instruction in their duties can help to improve the control of processes and minimise consumption and emission levels and the risk of accidents. This may be undertaken with in-house or external environmental advisers, but they cannot be responsible for the ongoing environmental management of the process. Problems which can arise during routine operations, start-up, shut-down, cleaning, maintenance, abnormal conditions and non-routine work should all be covered. Ongoing risk assessment of processes and work areas and the monitoring of compliance with identified standards and operating practices can then be undertaken by managers in partnership with shop floor employees.

Training provision requires an investment of time by all personnel for the provision of information, instruction, training and supervision and the operation of an assessment programme, to identify training needs and the effectiveness of training.

Achieved environmental benefits

Reduced consumption and emission levels and reduced risks of accidents throughout the installation.

Operational data

Numerous examples exist for environmental benefits, including the prevention of accidents, that result from optimised operation through training, e.g.

- avoiding spillage when disconnecting pipes and hoses, e.g. during the bulk delivery of milk; cleaning chemicals, such as caustic and organic solvents, such as hexane for vegetable oil refining
- preventing product losses or spillages in warehouses by ensuring workers, e.g. forklift truck drivers, are trained
- ensuring that vessels and hoses are drained before disconnection
- discharging malodorous liquids below the liquid level in a vessel or back venting raw material deliveries into the delivering road tanker are both relatively easy and cost effective to initiate and can control odour emissions
- ensuring that noisy equipment, for which the noise levels cannot be reduced sufficiently at source, is operated for the minimum time necessary and that noise reduction measures to protect the environment, such as closing doors and windows, are always applied. Community provisions on health and safety at the workplace [243, EC, 2003] are also relevant.

Applicability

Applicable to all FDM installations.

Driving force for implementation

Routinely, considering the environmental impacts can help to focus efforts for achieving lower consumption and emission levels, leading to cost savings and increasing the confidence of the regulatory authority.

Example plants

Many FDM installations.

Reference literature

[205, DoE SO and WO, 1997]

4.1.3 Equipment design

4.1.3.1 Design equipment to minimise consumption and emission levels

Description

Careful design of pumping and conveying equipment can prevent solid, liquid and gas emissions. Energy consumption can be minimised by, e.g. energy-optimised planning, including re-use of heat and use of insulation. Tanks, pumps, compressor seals and valves and process drains can be major sources of leaks. Examples of effective design considerations include: identifying and marking all valves and equipment settings to reduce the risk that they will be set incorrectly by staff; optimising pipework systems and equipment capacity to minimise product losses and optimising the extraction and abatement capacity to minimise air emissions, e.g. during loading and unloading and installing pipes at an angle to promote self-draining.

Designing equipment which is easy to clean makes the recovery of product easier for either its intended use in the process, or for other uses such as animal feed. This dry cleaning can also reduce water consumption and waste water generation.

Designing the equipment to minimise transshipment operations can also reduce the risk of spillage and emissions to air.

Achieved environmental benefits

Reduced consumption of energy, water and substances, and reduced emissions to air, water and land.

Operational data

Examples of ways of minimising air emissions through design of equipment include fitting tanks with floating roofs, or pumps with double mechanical seals. Refrigeration plants and other equipment, e.g. boilers and cooling towers, can be adequately sized for the maximum expected demand and adequately controlled to always supply the required demand. The use of accurate measurements and often elaborate control mechanisms can sometimes minimise the generation of air emissions. The control systems in place also require regular and effective maintenance to ensure proper and continued operation.

Conveyors can be completely enclosed and sealed, or fitted with hoods with local exhaust ventilation designed to trap emissions, when enclosure is not feasible. Minimising the length of conveyors and the number of transfer points can reduce emissions. Conveyors can be self-emptying, without dead spaces and provided with drainage to facilitate cleaning.

Noise can be minimised by ensuring, whenever possible, that motors are mechanically isolated from connected ducts or pipes. In addition, for fluid systems, silencers or pulsation dampers can be used to reduce the transmission of fluid-borne noise into the pipe system. For materials handling systems, e.g. chutes and hoppers, the noise generated by impacts between the material and the chute or hopper can be minimised by avoiding abrupt changes in direction and minimising the impact forces, e.g. by maintaining sliding contact of products with chutes and minimising the height of the fall. If impacts cannot be avoided, then noise deadening lining material can be provided.

Maintenance can be taken into consideration at the design stage by, e.g. making water pipework, valves and instrumentation readily accessible for maintenance.

Integrating process techniques may be possible, to maximise possible product yield and minimise emissions into the environment as a whole.

Applicability

Applicable to all FDM installations.

Driving force for implementation

Reduced consumption and emission levels and their associated costs.

Reference literature

[13, Environment Agency of England and Wales, 2000, 31, VITO, et al., 2001, 34, Willey A R and Williams D A, 2001, 65, Germany, 2002, 182, Germany, 2003, 200, CIAA, 2003, 234, UK, 2003, 242, Lewis D. N., 2003]

4.1.3.2 Selection of efficient and quiet fans

Description

The principal cause of fan noise is turbulence and local slowing of flowrates due to vortex shedding. Vortex shedding is the periodic detachment of vortices from an object in a fluid flow, causing a varying force to be experienced by the object.

The most efficient and the quietest fans are usually the ones with the lowest blade tip speed, i.e. those with a large diameter and a low speed. For a given duty, a backward-curved or backward-inclined fan working at peak efficiency is quieter than a radial tipped fan.

Additional noise reduction measures include using flexible connections between fans and ducts to minimise the transmission of vibration and mounting fans on vibration isolators to prevent transmission of vibration to supporting structures.

Achieved environmental benefits

Reduced noise emissions.

Operational data

In an example spray drier, a fixed speed 2500 rpm fan delivering approximately 45000 m³/h was replaced with two smaller fans running at 1500 rpm and delivering the same total air volume. Control of the new fans was obtained by reducing their speed, rather than using a damper. The net reduction in noise was approximately 8 dB(A). Table 4.2 shows the noise reduction that can be expected from reducing the fan speed. Every 3 dB(A) reduction is equivalent to halving the noise level.

Fan speed reduction	Noise reduction
10 %	2 dB(A)
20 %	5 dB(A)
30 %	8 dB(A)
40 %	11 dB(A)
50 %	15 dB(A)

Table 4.2: A guide to the noise reduction expected from reducing fan speeds

Applicability

Applicable where fans are used, e.g. for air conditioning, ventilation and refrigeration.

Economics

The cheapest fans are usually those with the smallest diameter, but these tend to be the noisiest. The cost of a fan is, however, usually a relatively small proportion of any overall project and the cost is, therefore, not used as the governing factor.

Driving force for implementation

Reduced complaints about noise emissions from outside the installation.

Reference literature

[200, CIAA, 2003, 242, Lewis D. N., 2003]

4.1.3.3 Selection of fans with low numbers of blades

Description

Fan noises are transmitted over long distances. The higher frequencies, from fans with many blades, tend to dissipate over shorter distances than the lower frequencies emitted from fans with fewer blades. Figure 4.1 shows the effect of modifying a roof-mounted fan to produce a higher frequency noise.

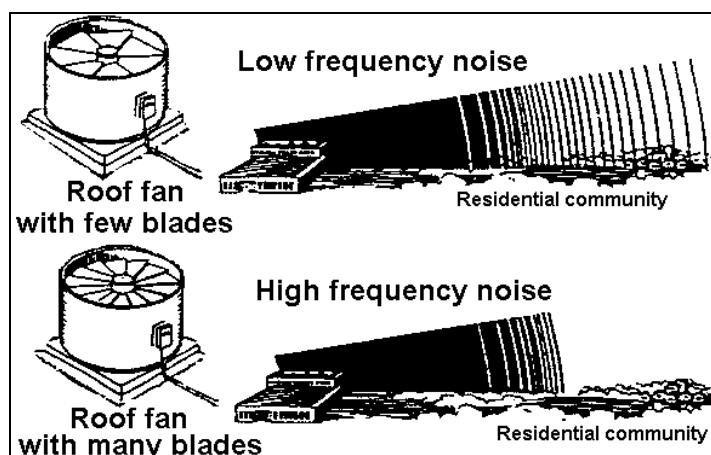

Figure 4.1: The effect of the number of fan blades on the distance of noise transmission

Achieved environmental benefits

Reduced noise emissions.

Applicability

Applicable where fans are used, e.g. for air conditioning, ventilation and refrigeration.

Driving force for implementation

Reduced complaints about noise emissions from outside the installation.

Reference literature

[65, Germany, 2002]

4.1.3.4 Designing pipework to minimise noise emissionsDescription

Pipes can be enclosed within walls or laid in special ducts to reduce noise immission levels. Optimum results are achieved by either lining or filling cavities with sound absorbing material. Sound insulation can be improved by:

- selecting pipe material with sound insulating properties, e.g. cast iron instead of plastic
- increasing the thickness of the pipe wall
- insulating the pipe.

The material and the geometry of the pipe wall determine the propagation of the airborne noise. Damping the vibrations in the pipe wall that give rise to airborne noise causes a reduction in sound energy by absorption, as the sound spreads through the fluid. This damping effect is not important at low frequencies, but increases as the frequency rises. The damping effect decreases as the pipe diameter increases. Irregularities in the surface of the pipe also increase the damping effect. If pipes have a sound-absorbing inner lining, then at higher flow speeds the damping is considerably reduced for sound propagation in the direction of flow and increased for sound propagation against the direction of flow.

When dimensioning pipes, it is important to ensure that the principal excitation frequency of the sound level entering the pipe is sufficiently far from the natural frequencies and pass frequencies of the pipes. All natural frequencies are influenced by the way the pipes are mounted, the route taken by the pipe, e.g. the number and position of bends and any internal baffles.

Achieved environmental benefits

Reduced noise emissions.

Operational data

Pipes are used to transport gases, vapours, liquids and solids with a carrier fluid. The noise emissions arising from pipes include noise transmitted by the fluids and solids, as well as airborne noise transmission. Virtually no noise results from laminar flows, but increasing turbulence leads to increased noise levels within pipes.

Cavitation causes intensive noise. Cavitation occurs when the static pressure is locally equal to or less than the vapour pressure, and occurs, e.g. where the direction of flow is changed.

When solids are transported with the aid of carrier fluids, additional noise results from contact of the solid particles with each other and with the walls of the pipe, particularly when hard particles are transported using a gaseous fluid. The sound pressure level depends on the flowrate, the material of the pipe, and the type of solid. Sound pressure levels may reach between 85 and 100 dB(A) at a distance of 1 metre from straight pipe elements. This can be expected to increase by a further 10 – 15 dB(A) near bends.

Applicability

Applicable where pipes are used to transport gases, vapours, liquids and solids with a carrier fluid.

Driving force for implementation

Prevention of occupational noise induced hearing loss and reduced complaints about noise emissions from outside the installation.

Reference literature

[65, Germany, 2002]

4.1.3.5 Sound insulation of equipment

Description

Sound insulating enclosures can be built around sources of noise pollution. An insulating enclosure usually consists of a metal jacket lined with absorber material which wholly or partially encloses the sound source. The noise level reduction that can be achieved depends on the insulation of airborne sound by the walls and the absorption capacity of the internal lining. The size, shape and materials for the screen can be determined by acoustic design calculations to ensure that particular design targets, i.e. noise emission levels, are met. Connecting fans and the ducts or housings using elastic linkages and placing noisy equipment on noise absorbing bases can also reduce noise emission levels.

Achieved environmental benefits

Reduced noise emissions.

Operational data

Some examples of uses of sound insulation materials in the FDM sector include:

- for glass bottling lines, enclosing glass bottle conveyors and cap feeder hoppers
- lining insides of hoppers with impact deadening material and lining outsides of hoppers and guard panels
- at packing machines, lining cover panels and enclosing bagging lines
- in the meat sector, fitting noise dampening hoods over bowl choppers
- in the dairy sector, enclosing homogenisers (e.g. in sound insulated rooms which require infrequent access)
- enclosing spray driers (e.g. in sound insulated rooms which require infrequent access)
- in milling operations, enclosing hammer mills, roller mills and mixers
- in freezers and coldstores, enclosing the refrigeration machinery allowing for the ventilation of motors and fans
- enclosing vapour compressors.

For some applications it may be necessary to allow the entry or release of air from an acoustic enclosure. This reduces the noise reduction potential, but the effect of this may be reduced by designing bends in the airways to abate the noise emissions. For example, fans can be enclosed in sound insulating enclosures designed to minimise the build-up of reflected noise inside the enclosure and adequate ventilation for cooling of the fan needs to be provided.

For ductwork, instead of fitting silencers, it is often possible to achieve a 10 – 20 dB(A) reduction in airborne noise from a duct or opening by lining the last bend in the ductwork with a noise absorbing material or by constructing a simple absorbent lined right-angled bend to fit on the opening. It is reported that either side of the bend should be lined along a length equivalent to twice the duct diameter.

Applicability

A variety of equipment used in the FDM sector, e.g. fans, compressors, pumps and blowers.

Driving force for implementation

Prevention of occupational noise induced hearing loss and reduced complaints about noise emissions from outside the installation.

Example plants

Insulation of noisy equipment is widely applied in the FDM sector, e.g. at glass bottling lines; at hoppers where there is noisy product impact; during packing, e.g. while wrapping, cutting and bagging; at bowl choppers used in the meat sector; in grain milling, e.g. in the manufacture of flour and animal feed and in freezing and cold storage.

Reference literature

[200, CIAA, 2003, 242, Lewis D. N., 2003]

4.1.3.6 Position equipment to direct noise away from neighboursDescription

Some equipment emits different noise levels in different directions. For example, any equipment which has a fan inlet or outlet on one side will have its maximum noise level on that side. Positioning the equipment so that the noisiest side faces away from a sensitive location could, therefore, reduce the immission levels there. This cannot be guaranteed to always be effective because the direction that sound is carried varies with weather conditions.

Achieved environmental benefits

Reduced noise levels at receptor sites away from the noisy side of the equipment.

Cross-media effects

The emission of noise is not prevented or reduced at all and there may be the risk of occupational noise induced hearing loss or complaints may remain.

Applicability

Applicable to cooling towers, condensers, compressors, pumps and blowers.

Driving force for implementation

Reduced noise levels at sensitive receptor sites.

Reference literature

[65, Germany, 2002, 200, CIAA, 2003, 242, Lewis D. N., 2003]

4.1.4 Installation design considerationsDescription

There are a number of factors to consider in the initial design of a building to control the generation of air emissions and noise.

Achieved environmental benefits

Reduced air emissions and, in many cases, reduced waste.

Operational data

The storage and handling of raw materials is a particular concern for malodorous emissions. For instance, the storage area can be designed to facilitate the operation of a first in first out system. This can be helped by hopper storage which ensures the materials received first are used first, i.e. the hopper is filled at the top and emptied from the bottom. This enables materials to be used fresh, so the use of raw materials is optimised and minimises waste generation.

The risk of product losses or spillages can be reduced in warehouses by ensuring they are designed for easy and safe use, e.g. racking can be designed for efficient use with a forklift truck.

Areas used for loading and unloading can be well designed to facilitate frequent and effective cleaning, by providing smooth surfaces and minimising corners and other places which are difficult to gain access to and to clean.

For extremely polluting materials, the building can be designed so that during abnormal conditions when normal control systems would be sufficient, there are no air emissions from, e.g. malfunctioning equipment, leaks or during repairs. The number of entry points can be minimised and these can be protected by double doors with an airlock between.

Designing rooms with smooth walls and rounded corners that are easy to clean can also optimise the recovery of materials for use or disposal. This can also reduce water and detergent use for cleaning and consequently also waste water volumes and loads.

Applicability

Applicable to all FDM installations.

Driving force for implementation

Reduced air emissions and, in many cases, reduced waste and waste water generation.

Reference literature

[34, Willey A R and Williams D A, 2001]

4.1.4.1 Sound insulation of buildings

Description

The acoustic output of machines and the acoustic properties of the rooms determine the sound pressure levels inside a building. These internal sound pressure levels and the sound insulation provided by the external shell, i.e. walls, roofs, windows, doors and openings result in the airborne sound power, i.e. the emission level. This can be a particular problem when equipment is inside steel frame buildings with relatively lightweight profiled cladding. The acoustic power of a source is related to its surface area. Large building facades can, therefore, radiate significant acoustic power.

Buildings can be insulated against airborne noise. It is much easier to insulate against high frequency noise than low frequency noise. Either single-shell or double-shell insulation can be provided. The sound insulation of components of a more or less homogeneous structure depends largely on their weight per unit area. The nature of the material is also important.

Double-shell buildings consist of two dense shells separated by an air gap or a resilient insulating layer. Under certain conditions, the sound insulation provided by such elements is greater than that of single-shell elements of the same weight. The most important requirement for better sound insulation is that the air gap between the shells is sufficiently large or that any insulating layer between the shells is sufficiently resilient and open textured. The insulating effect of the cavity is achieved by filling it with sound absorbing materials, e.g. mineral fibre panels. Rigid connections between the double shells have an adverse effect on sound insulation.

The sound insulation of any wall is only as good as the weakest link. The sound insulation of windows, doors, roofs and louvres has to be considered so that sound insulation of the composite structure can be calculated. If the sound reduction index of windows and doors matches or approaches that of the wall, then the overall performance will be maintained. If a poor fitting door and a light window is installed in a block wall, this will significantly reduce the noise reduction possible.

If particular design targets are to be met, the size, shape and materials for the screen should be determined by acoustic design calculations.

Achieved environmental benefits

Reduced noise emissions.

Applicability

Applicable to all FDM installations, e.g. where fans are used for air conditioning, ventilation and refrigeration.

Driving force for implementation

Reduced complaints about noise emissions from outside the installation.

Reference literature

[65, Germany, 2002, 200, CIAA, 2003, 242, Lewis D. N., 2003]

4.1.4.2 Shielding buildings from noise immission sitesDescription

Shielding buildings from immission sites has the effect of reducing the sound pressure level at those sites. Other buildings in the vicinity may provide the shielding effect, or this can be manufactured by constructing barriers such as walls or embankments. It is reported that these can achieve a shielding effect of more than 5 dB(A) if they at least interrupt the line-of-sight connection. The higher the barrier and the closer it is to the noise source and/or immission site, the greater the shielding effect.

Achieved environmental benefits

Reduced noise emissions.

Cross-media effects

The emission of noise is not prevented or reduced at all and there may be the risk of occupational noise induced hearing loss or complaints may remain.

Applicability

Applicable to all FDM installations, e.g. where fans, cooling towers and condensers are used.

Driving force for implementation

Reduced complaints about noise emissions from outside the installation.

Reference literature

[65, Germany, 2002]

4.1.4.3 Application of a spiral turbulence generator to a chimney to minimise noise emissionsDescription

Airflowing past towers and chimneys creates noise, due to eddies and also excites vibrations in the chimney. Applying a spiral turbulence generator interferes with the eddy formation. The gradient of the turbulence generator is not constant. The technique is shown in Figure 4.2.

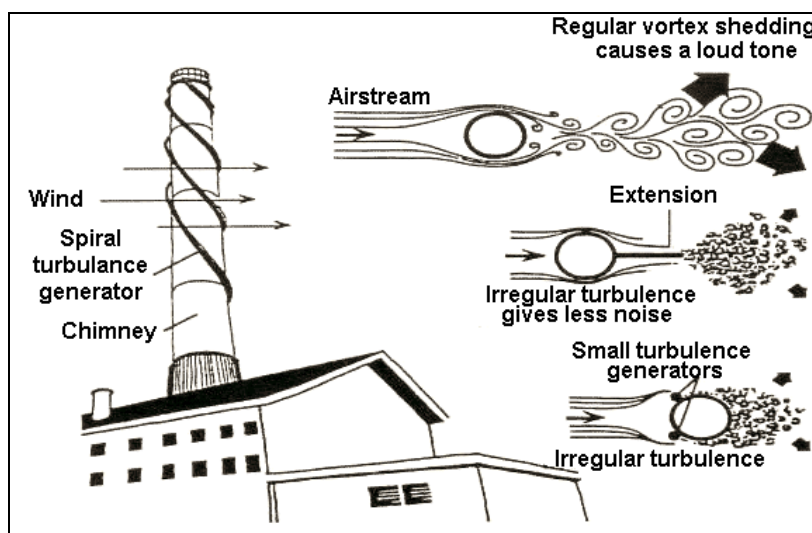

Figure 4.2: Reduction in noise emissions from a chimney

Achieved environmental benefits

Reduced noise emissions.

Applicability

Applicable where fans are used, e.g. for air conditioning, ventilation and refrigeration.

Driving force for implementation

Reduced complaints about noise emissions from outside the installation.

Reference literature

[65, Germany, 2002]

4.1.5 Maintenance

Description

The effective planned preventive maintenance of vessels and equipment can minimise the frequency and size of solid, liquid and gas emissions, as well as water and energy consumption. For example, tanks, pumping and conveying equipment, compressor seals, valves and process drains can be major sources of leaks. Faulty process control equipment can lead to leaks, overflow and loss through dripping.

The correct operation of the process installation can be regularly reviewed and any deviations or modifications can be assessed in terms of their impact. Simple modifications to a process can often result in considerable reductions in air emissions.

Achieved environmental benefits

Reduced consumption of energy, water and substances, and reduced emissions to air, water and land. Reduced waste, e.g. through co-product/by-product recovery. Reduced noise emissions.

Operational data

In general, the maintenance of utility systems receives much lower priority than maintenance that has a direct impact on production or safety. This can be a major contributing factor in excessive water use and unnecessary waste water generation. A well operated maintenance regime can ensure, e.g. the prompt repair of water leaks and faults which can lead to overflow or spillage to drains. Optimisation of the cooling water systems can avoid excessive blowdown of the cooling tower.

Examples of maintenance practices include:

General

- reporting and fixing leaks promptly
- checking that grab edges meet properly to avoid trickling losses, during transshipment of dusty solids.

Steam

- ensuring that inspection of steam traps is a documented routine activity
- repairing steam leaks
- ensuring that a documented system for reporting and rectifying steam leaks is in place
- ensuring that the repair of steam leaks is given high priority. Costs can soon mount up with only a few leaking valve glands.

Compressed air

- initiating an effective system for reporting leaks
- carrying out an “out of hours” survey, to listen for leaks, locate and tag them
- repairing leaks.

Refrigerant

- checking the refrigerant sight glass for bubbles. Bubbles in the sight glass usually mean a system is leaking
- finding the leaks and repairing them before the system is recharged with refrigerant
- checking that the oil in the compressor sight glass(es) is at the right level. The compressor will be more likely to fail if the oil level is too low, or too high.

Cooling

- leakage of materials into a cooling water system or operation of a cooling tower system to cool contaminated process water directly, can greatly increase odour problems.

Fish

- maintaining skinning machinery, e.g. by keeping blades sharp, to ensure efficient skinning and to minimise the removal of fish flesh with the skin.

Fruit and vegetables

- using sharp cutting heads during fruit and vegetable cutting processes.

Applicability

Applicable to all FDM installations.

Driving force for implementation

Smooth untroubled production which is not interrupted by breakdowns and accidents. Legislation, e.g. it is illegal to knowingly vent certain refrigerants.

Example plants

Preventive maintenance is widely applied in the whole FDM sector.

Reference literature

[1, CIAA, 2002, 13, Environment Agency of England and Wales, 2000, 31, VITO, et al., 2001, 69, Environment Agency of England and Wales, 2001, 134, AWARENET, 2002, 200, CIAA, 2003]

4.1.6 Methodology for preventing and minimising the consumption of water and energy and the production of waste

Prevention and minimisation requires the adoption of a systematic approach. A successful methodology usually consists of the steps described in the following sections [1, CIAA, 2002]. These steps are described:

- step 1: obtaining management commitment, organisation and planning
- step 2: analysis of production processes
- step 3: assessment of objectives
- step 4: identifying prevention and minimisation options
- step 5: carrying out an evaluation and feasibility study
- step 6: implementing the prevention and minimisation programme
- step 7: ongoing monitoring by measurement and visual inspection.

The importance of preventing and minimising the consumption of water and energy, and waste production is described below.

Preventing and minimising water consumption

The supply of water is not unlimited, so control of its consumption is necessary. This is an important aspect of the conservation of natural resources. In the FDM sector, the required food safety and hygiene standards have to be achieved. This means that cleaning of equipment and installations consumes a major proportion of the water used in the sector. Taking a systematic approach to the management of water use can lead to reduced water consumption. Reduced water consumption also leads to reduced volumes of waste water for treatment. Preventing or, if this is not feasible, minimising water pollution, used in combination with other techniques, can lead to a reduction in water pollution.

Water pollution control can be achieved by:

- reducing the volume of the waste water generated
- reducing the strength of the waste water generated
- eliminating or decreasing the concentration of certain pollutants, particularly the priority pollutants
- recycling or re-using water
- waste water treatment.

Preventing and minimising energy consumption

In many of the FDM sectors, energy consumption is an important cost factor. Depending on the nature of the production activities, energy costs may vary from less than 1 % to more than 10 % of the production costs. Taking a systematic approach to reduce energy consumption is an important issue, both from the point of view of the environmental impact, e.g. greenhouse effect, and also due to cost savings.

The concept of energy efficiency is frequently used to measure the energy consumption in an industrial installation. Energy efficiency is often defined as the amount of energy consumed per unit of product. Improving energy efficiency, therefore, means reducing the amount of energy per unit of product. This will result in energy savings at an installation level if the product output remains at a constant level. In improving the energy efficiency, two aspects can be distinguished:

- a reduction of the energy consumption by efficient energy management
- a reduction of the energy consumption by process optimisation and innovation.

Energy management is an approach to controlling and minimising energy consumption and energy costs. It depends, to a large extent, upon placing accountability for consumption on those individuals who are responsible for using it. An essential part of energy management is monitoring and targeting. In several case studies, energy savings of 5 – 15 % are reported.

A further step in improving energy efficiency can be made by process optimisation and innovation. Sometimes this requires only minor investments. Nevertheless, for innovations that have an important impact both on the process and energy consumption, larger investments may be necessary. Investments in process optimisation and innovation without an efficient system of energy management cannot give a good insight into whether the expected energy savings are actually realised. Furthermore, it is possible that the effect of the energy savings gained by process adaptations can be offset if good housekeeping is not maintained.

An illustration of the relationship between the effects of efficient energy management and implementing energy saving measures, e.g. process optimisation and innovation, is given in Figure 4.3.

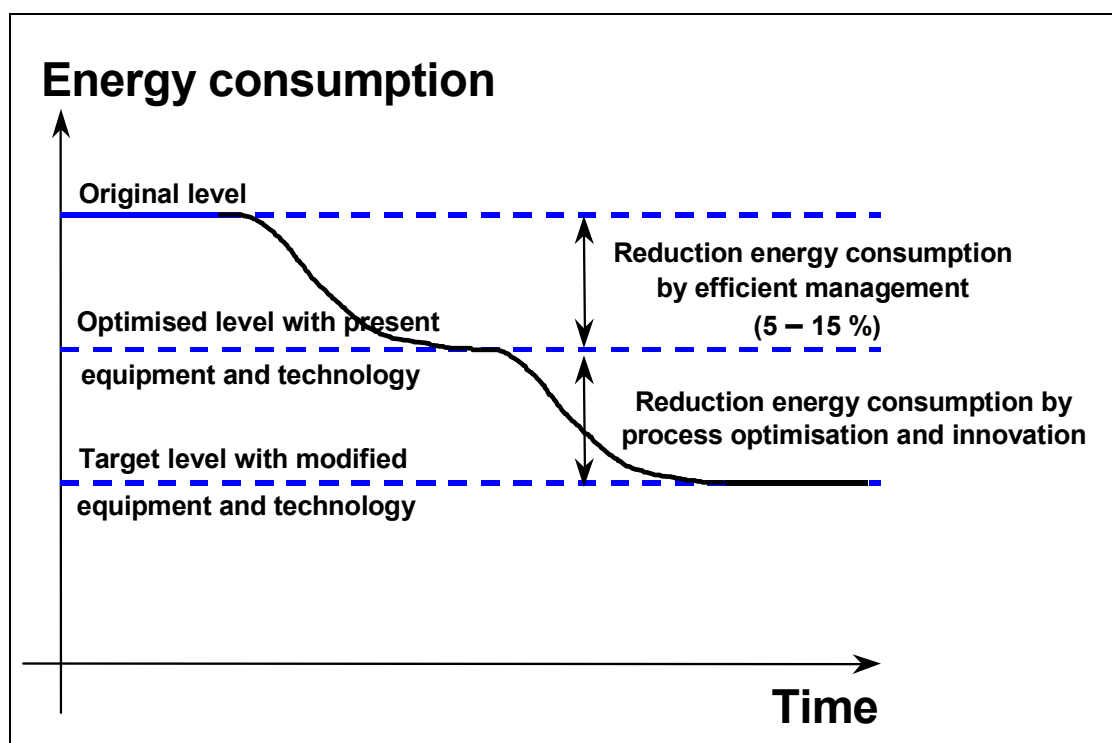

Figure 4.3: Reduction in energy consumption
[1, CIAA, 2002]

Preventing and minimising waste production

Avoidance of waste production is one of the main objectives of the IPPC Directive. Article 3 (c) states “MSs shall take the necessary measures to provide that the competent authorities ensure that installations are operated in such a way that...(c) waste production is avoided in accordance with Council Directive 75/442/EEC of 15 July 1975 on waste; where waste is produced, it is recovered or, where that is technically and economically impossible, it is disposed of while avoiding or reducing any impact on the environment”. Annex IV states “Considerations to be taken into account generally or in specific cases when determining best available techniques, as defined in Article 2(11), bearing in mind the likely costs and benefits of a measure and the principles of precaution and prevention: 1. the use of low waste technology; and 3. the furthering of recovery and recycling of substances generated and used in the process and of waste, where appropriate;”

Techniques which describe the use, re-use, recovery and recycling of by-products, co-products, residues and materials that can be prevented from becoming waste are described in this chapter. For example, the use of materials originally intended for use in food products, but which do not meet the customers specification but are otherwise fit for consumption, may be suitable for use in animal feed.

In some specific cases, some authorities regard or accept landspreading to be recycling or recovery. Some authorities prohibit it by legislation. In any case, landspreading should only be done in accordance with EU environmental legislation including the nitrate Directive [194, EC, 1991], which requires measures to be taken concerning the storage and the application on land of all nitrogen compounds and deals with certain land management practices and contains provisions about when spreading is forbidden or inappropriate. Before any substance is spread on land, there are a number of important considerations which need to be assessed, e.g. agronomic interests, i.e. relating to the science of soil management and crop production; hygiene and traceability. It is reported that some transport/washing/process water, surplus biomass from biological WWTPs and other solid residues are sometimes spread on land. For example, potato fruit water, wheat solubles and the sludge from the waste water treatment in the starch industry and sugar beet transport water, possibly after settlement, can potentially be sent

for landspreading. Some examples of issues to consider when assessing whether landspreading is a possible option are:

- whether the substances spread have a real nutritional benefit to plants. Such benefits might include, e.g. improving the pH balance of the soil, or providing fertilising elements such as phosphorus and nitrogen
- whether there are geographic; pedologic, i.e. the branch of science which deals with soil, especially its formation, nature and classification; climatic and hydrogeologic data which may affect either food or livestock hygiene or the environmental impact of spreading the substance [81, France, 2001]
- whether, at all stages in the operation, it is possible to identify the origin and the destination of the spread substances, depends on close co-operation between the producer of the substance to be spread and the person controlling the landspreading operation, e.g. the farmer [81, France, 2001]
- the requirement for monitoring the predicted effect, e.g. by analysis of the soil and the groundwater [81, France, 2001].

The **objective** of a waste prevention programme is to reduce the environmental impact of manufacturing operations as much as practicably possible, taking into account economics and the environmental benefit, and being consistent with meeting all the regulatory requirements. Minimisation of the wastage of both material and energy achieve legal compliance; reduced financial costs to the producer associated with loss of product and raw material and payment for disposal both on- and off-site. It conserves natural resources.

Hygiene and food safety considerations, using HACCP are paramount in the production of FDM. Waste prevention measures cannot be allowed to endanger the bacteriological quality of the product, e.g. if there is any doubt about meeting quality standards, the product is reprocessed or rejected as waste. Furthermore, thorough cleaning is necessary to meet a required level of cleanliness and hygiene, but this then leads to waste water. Typically, savings can be made in cleaning operations, resulting in less contaminated water and chemicals going to the drain, but without endangering hygiene in the final product.

This methodology provides guidance on management of waste prevention, thereby also allowing reductions to be made in the loss of raw materials, products and auxiliary materials and consequently in costs. Where appropriate, case studies and reported examples are used to demonstrate successful waste minimisation measures. Preventing waste generation from accidental releases is discussed separately in Section 4.6.

Information on waste minimisation methodologies can be found in various guides, such as the UK Environment Agency's (2001): "Waste Minimisation – An Environmental Good Practice Guide For Industry", [64, Environment Agency of England and Wales, 2001] and in publications of the Environmental Technology Best Practice Programme series such as "Waste Minimisation Pays: Five Business Reasons for Reducing Waste – GG 125" [62, Envirowise (UK), et al., 1998], or "Cutting Costs by Reducing Waste: Running a Workshop to Stimulate Action – GG 106" [63, Envirowise (UK) and William Battle Associates., 1998]. Applying effective techniques in each of the key wastage areas is likely to give significant environmental benefits. An example methodology used in waste prevention and minimisation is shown in Figure 4.4.

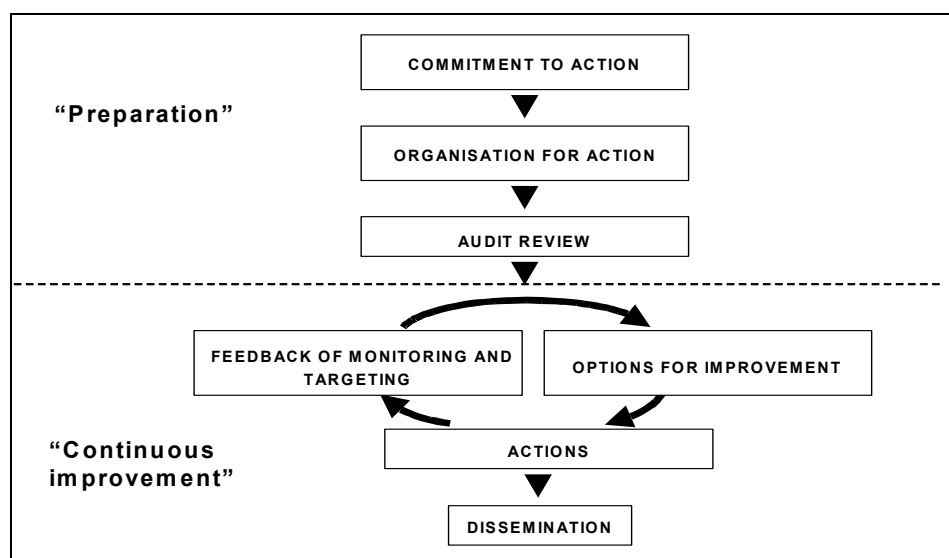

Figure 4.4: Example of a waste prevention and minimisation methodology [11, Environment Agency of England and Wales, 2000]

4.1.6.1 Step 1: Obtaining management commitment, organisation and planning

Obtaining management commitment

To be successful, the programmes for preventing and minimising water and energy consumption, and waste production require commitment at senior management level. This can ensure that all individuals within the organisation work together in a positive manner to gain maximum benefit from the initiative. One of the best ways of gaining senior management commitment is to convince the managers of the financial benefits that can be achieved.

It is advisable to start by identifying one or two areas where substantial amounts of materials or products are lost, where waste is produced or high water and energy consumption levels are registered and then showing the associated costs for the company. This cost survey includes the cost of wasted raw materials, rework, lost production time, waste treatment costs, wasted labour, loss of materials to the air and to the drain, as well as the excessive use of energy and water.

Sometimes up to 25 % of the raw material, or product equivalent, goes to waste or to the drain. Senior management may often be unaware of the scale of losses and highlighting them may provoke full support from senior management for the prevention and minimisation programme.

Organisation (establishing a project team) (see also Section 4.1.7.5)

It is usually beneficial to appoint a team leader or company champion to co-ordinate and facilitate the programmes. Using project teams and champions can help to increase awareness at all levels and to motivate individuals to take action and participate. The team leader and the project team can be responsible for carrying out assessments and for developing and evaluating proposals and measures [63, Envirowise (UK) and William Battle Associates., 1998].

Planning

Drawing up a detailed project plan together with a time schedule stating when activities need to be carried out can assist the prevention and minimisation programme. This is successful if progress is monitored and individuals with responsibilities to take action are appointed and held to account.

4.1.6.2 Step 2: Analysis of production processes

An important condition for successful prevention and minimisation of energy and water consumption, and waste production is to have a good overview of the areas and process steps that are relevant to the loss of materials, the generation of waste and the consumption levels. Such an overview makes it easier to identify measures. This requires a detailed inventory of all of the production processes. In developing this inventory, three levels of measurement can be distinguished.

Collection of quantitative data at the site level

At this level, data on quantities and costs are collected for the total installation, i.e. whole site. Most data should already be available within the company recording systems, e.g. stock records, accounts, purchase receipts, waste disposal receipts and production data. Where information is not available, estimates or direct measurements are required.

The quantities of all raw materials, energy, water and wastes usually cover an annual period. The units need to be consistent. This is essential to allow quantities and activities to be compared in a meaningful way both now and in the future.

Information can be collected in a systematic manner to ensure that the initial assessment is made as complete as possible. Typically, it is useful to keep a paper or electronic database of all the information collected.

Inventory for each process step

The objective of this step is to get an overview of all the production processes and related environmental aspects. Production processes can usefully be represented by a flowchart showing inputs, outputs and environmental problem areas.

Figure 4.5 shows one example of an input/output worksheet. This may be represented in other formats [60, Environment Agency of England and Wales, 1998].

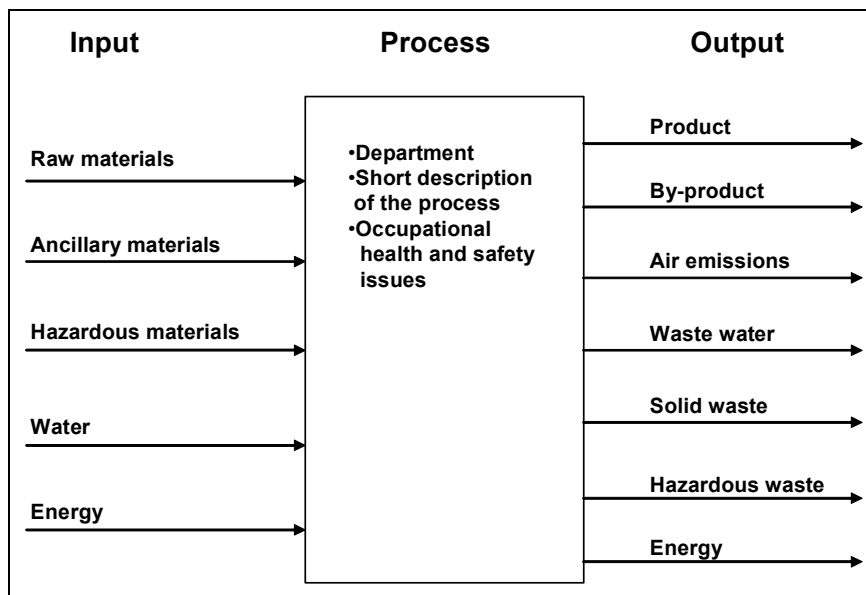

Figure 4.5: Example work sheet to identify input/output and environmental issues [1, CIAA, 2002]

A mass balance can be made to account for the consumption of raw materials and services, and the losses, wastes and emissions that result from the process. A mass balance makes it possible to identify and quantify previously unknown losses, wastes and emissions, and also provides an indication of their sources and causes. Mass balances are easier, more meaningful, and more accurate when they are undertaken for individual process steps. An overall installation-wide mass balance can then be constructed from these.

The mass balance can also be used to identify the costs associated with inputs, outputs and identified losses. Environmental performance indicators for the process can be developed from the mass balance data.

Inventory of selected parts

Depending on the inventory at process step level, certain parts of the process/installation may need further analysis for prevention and minimisation options. This requires a more detailed inventory focusing on the most significant aspects or process areas.

4.1.6.2.1 Analysis of production processes aimed at the prevention and minimisation of water consumption

First, the water input and water output of the total installation is examined. The use and production of the water is taken into account, including recycled and re-used water; water incorporated in the product, e.g. drinks, canned fruits and vegetables, or evaporated water and water used in cleaning. A distinction is usually made between the total and the fresh water used. The overall water consumption and emission levels for an example installation are shown in Figure 4.6.

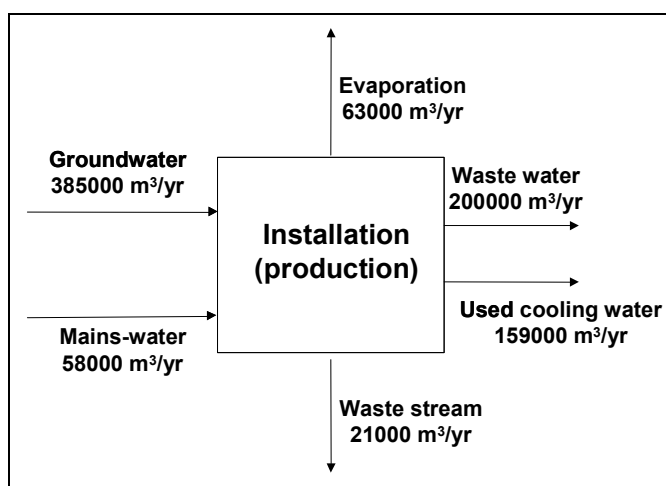

Figure 4.6: Overview of the water input and output of an example installation [1, CIAA, 2002]

Then, a monitoring system needs to be set up. This involves identifying the appropriate measuring points for water consumption and implementing a system for data collection, processing and reporting. The data can sometimes be obtained easily from existing flow measurements, bills for water and waste water discharges and any data provided for a permit. It may also be useful to give an overview of the costs that are related to water input and output, as this will show where financial savings can be made.

On the basis of the information gathered at this stage, benchmarks can be identified. Some examples of benchmarks are:

- specific water consumption (m^3 water/tonne of raw material or finished product)
- specific waste water discharge (m^3 water/tonne of raw material or finished product)
- ratio of water costs between water input and water output
- water costs per product unit
- water loss as a percentage of water consumption.

Using such benchmarks and, if possible, comparing them with external benchmarks, may give an initial indication of whether or not savings are possible.

Depending on the type of installation, a distinction can be made between departments, types of processes and the main levels in a process. Apart from the production processes, water treatment, waste water treatment and cleaning activities need to be incorporated in the inventory to ensure all potential savings are identified.

Sometimes the water flows for the main processes and departments are already being measured. If not, metering equipment can be installed on the main streams, some even on a temporary basis. Alternatively, the water consumption of the various production processes can be estimated, e.g. on the basis of production volume, however, this gives less reliable results.

On the basis of the information gathered at this stage, it should be possible to select the areas to target for further investigations into water savings. Nevertheless, certain parts of the process may need further analysis for saving options. This requires a more detailed inventory of these parts. The selected parts are split up into logical building blocks, i.e. relevant process parts, unit-operations, equipment and installations. The water input and output are determined for each building block. Furthermore, it may be important to characterise the function of the water in that particular part, e.g. as transport water, washing water, product water, or cooling water.

Frequently, all the data that is needed in this detailed level may not be available. Missing data can be completed by performing additional measurements or by calculation from other data or even by estimation. It depends on how relevant the concerned water flow is in the overall scheme. The level of detail is kept to what is strictly necessary to avoid excessive time consumption and costs for the inventory. Furthermore, the parts of the installation under investigation need to be physically definable and to have logical recognisable names. The use of plans and flowcharts for each level and process part can assist, as can presenting the data in a uniform way. Flowchart software programs can be used for this.

In each process step, an assessment of the quality requirements of the water used can be made. The most important criteria generally are, depending on the type of process, the presence of organic material from raw materials and products; the presence of auxiliary substances in the water; the microbiological count; pH; chloride content; hardness and the iron and manganese content. It is advisable to group the processing steps requiring the same water quality together and to limit the defined water qualities to a maximum of 5 to 10. The defined quality requirements are such that the water quality should not affect the quality of the finished product. The qualities of the released flows of each processing step are also established. This information is necessary to judge whether it is possible to re-use water, either with or without intermediate treatment.

Finally, an estimate on the minimum water consumption can sometimes be obtained from external benchmarking. A prerequisite is that data are available for comparable activities. Another approach is to determine the minimum water consumption level based on the specifications, e.g. of the suppliers, and of the various parts of the process lines. Totalling the individual process water requirements throughout the installation leads to a theoretical water consumption design and enables standards or targets to be established.

4.1.6.2.2 Analysis of production processes aimed at the prevention and minimisation of energy consumption

Information about energy consumption is fundamental to identify where the most effective energy savings and cost effective improvements can be made. Furthermore, it is a basis for demonstrating that the installation is operated in an efficient manner and that energy saving measures are taken in the most appropriate areas.

First, the information needs to be broken down by energy source. As well as purchased electricity, this should also include fuels converted to energy at the site, heat imported directly from external sources and renewable energy sources. Recent values for delivered energy sources over a recent 12 month period may be used. Conversion to primary energy is advised. Where energy from a CHP installation is used (see Section 4.2.13.1.1), the calculated energy used is based on the energy input to the installation, not on the units of energy produced by the installation. An example worksheet for the breakdown of energy consumption can be seen in Table 4.3.

Energy source	Energy consumption		
	Delivered	Primary (kWh or MWh)	% of total
Electricity	MWh		
Gas	m ³		
Oil	tonnes		
Imported steam	tonnes		
Energy from waste/renewable sources	kWh (MJ)		
Other, specify			
Exported steam	tonnes		
Exported electricity	MWh		

Table 4.3: Example worksheet for the breakdown of the energy consumption
[1, CIAA, 2002]

Next, an analysis of the energy consumption of the equipment, per department or production line, is made. It is advisable to supplement the energy consumption information with energy balances or flow diagrams to illustrate how energy is used throughout the process. A Sankey diagram can be used to represent situations where energy conversion is highly integrated within the production activities (see an example in Section 4.2.13.1.1).

Finally, the specific energy consumption (SEC) is analysed. This means the amount of energy that is consumed per unit of raw material processed or product output.

4.1.6.2.3 Analysis of production processes aimed at the prevention and minimisation of waste production

Losses may occur at each stage in the production process, from reception to dispatch. For example, losses associated with poor storage and materials handling may be detected by keeping an accurate inventory of inputs and outputs at all stages of the process from the reception of raw materials to the dispatch of products and end-of-pipe treatments. These losses may be perceived or real losses. Some examples of causes of material losses and some methods of maintaining an accurate inventory are shown in Table 4.4.

Example causes of real and perceived material losses	Solution
Lack of monitoring of inputs and outputs at all stages of the process from reception of raw materials to dispatch of products and end-of-pipe treatments leading to actual losses and their causes and locations remaining unknown	Carry out a mass balance
Calculated specific yields showing the quantity of product produced per unit of raw material consumed or the relative yield showing the percentage of raw material converted to product not maintained	Calculate yields, set benchmarks and maintain them
Perceived or real over- or underfilling leading to spillage or off specification product	Provide, use and regularly calibrate meters
Over- or underpurchasing leading to deterioration of unused stock	Keep accurate accounts
Material volume changes due to temperature changes not recognised	Use conversion factors to take account of changes in volume due to temperature

Table 4.4: Examples of causes of material losses and some methods of maintaining an accurate inventory
[11, Environment Agency of England and Wales, 2000]

For example, the process flow diagram of a site for liquid milk production can be expanded with specific mass balances, giving an overview of where the main waste milk losses occur, as shown in Figure 4.7.

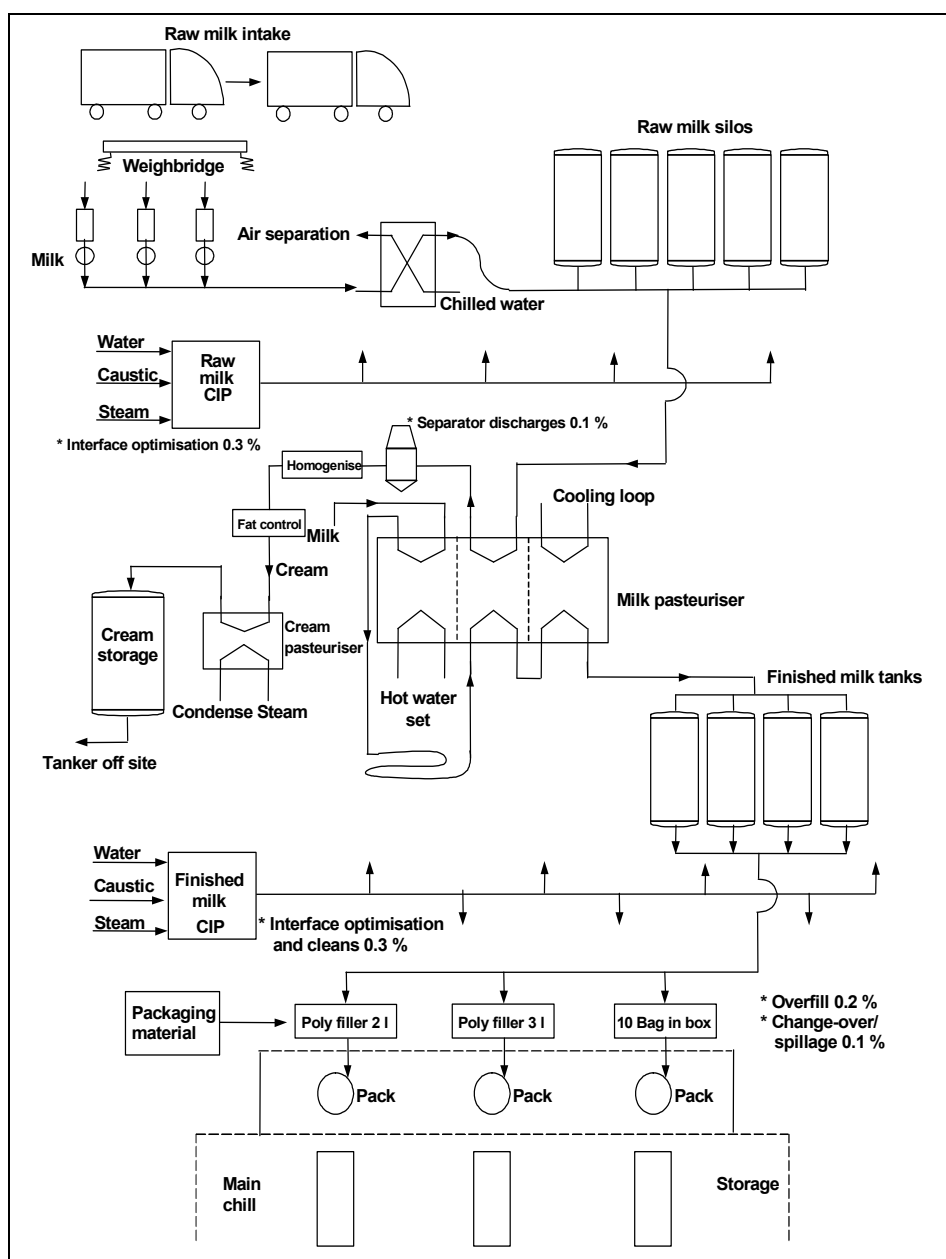

Figure 4.7: Detailed process flow diagram for liquid milk production [11, Environment Agency of England and Wales, 2000]

The above process flow diagram shows that the overall loss of raw milk from the process is 0.7 to 1.0 % and this is reported to be indicative of industry best practice. The key areas of waste milk generation identified in the diagram are shown in Table 4.5.

Raw milk CIP and associated installation	0.3 %
Processing - mainly centrifugal separator discharge	0.1 %
Finished milk CIP and associated installation	0.3 %
Overfilling during packaging	0.2 %
Change-over/spillage during packaging	0.1 %
Total raw milk loss*	1.0 %
*This analysis excludes any reclaimed process milk, which is typically 1.5 % and accounted for in waste reporting systems	

Table 4.5: Key areas of waste milk generation

4.1.6.3 Step 3: Assessment of objectives

Based on the analysis made in step 2, the objectives of the prevention and minimisation programme are assessed. The objectives include reduction targets, boundaries and time-scales. The objectives need to be measurable and scheduled into a programme plan so that they can be used to monitor if the programme is proceeding as planned. These objectives can be revised further in the process when implementing the actual prevention and minimisation programme (see step 6).

4.1.6.4 Step 4: Identifying prevention and minimisation options

Various approaches can be applied to identify measures to prevent and minimise water and energy consumption, and waste production, e.g. brainstorming, internal investigation, external consultancy and pinch technology (see Section 4.1.6.4.1).

Identifying prevention and minimisation options depend on the knowledge and creativity of the project team members and other staff, much of which, of course, comes from their own experience. Several options can often be found by carefully analysing the cause of any problem.

Alternatively, people from different parts of the organisation can meet to discuss solutions to specific problems in an open and non-threatening environment, during brainstorming sessions.

Additional ideas may be generated by hiring a consultant with specific expertise and letting him make a walk-through inspection.

For example, in the FDM sector, there are many measures that can be applied to reduce the amount of water used, e.g. elimination of the use of water, optimising process control (see Section 4.1.8), recycling and re-use of water, good housekeeping and maintenance (see Section 4.1.5). Some examples of possible water saving measures are shown in Table 4.6.

Water saving measure	Typical reduction in process use (%)
Closed-circuit water recycling	up to 90
CIP (new)	up to 60
Re-use of wash-water	up to 50
Countercurrent rinsing, e.g in CIP	up to 40
Good housekeeping	up to 30
Optimisation of CIP	up to 30
Spray/jet upgrades	up to 20
Brushes/squeegees	up to 20
Automatic shut-off	up to 15

Table 4.6: Typical achievable reductions in water use [23, Envirowise (UK) and Dames & Moore Ltd, 1998]

It is reported that, in the process of identifying energy efficiency measures, production processes, utilities and buildings need to be considered separately. There is a lot of information on energy efficiency techniques available from various public sources. However, the available techniques are strongly dependent on the particular site and the type of processes applied. Overall, total energy savings are usually the result of small savings in a number of areas. For example, reductions of up to 25 % are possible through improved housekeeping (see Section 4.1.7.11) and fine-tuning processes. The use of more energy efficient equipment, heat recovery and applying combined heat and power (CHP) generation (see Section 4.2.13.1.1) may also result in additional savings. An example pasta manufacturer indicated that an improvement in the energy efficiency of one of its boilers, from 85 to 90 %, could lead to a 5.56 % reduction in CO₂ emissions (considering a conversion factor of 84.6 kg CO₂/GJ).

Many measures applicable for reducing an environmental impact, e.g. reduction of energy consumption, have no effect on other polluting emissions associated with the installation. Such measures can be considered as “standalone” and are evaluated according to their individual economic and environmental benefits.

On the other hand, some measures can lead to positive or negative effects on other environmental issues, and in such cases, the wider environmental impacts need to be taken into account. In the case of trade-offs, e.g. between energy consumption and other environmental objectives, an assessment, taking into account the costs and environmental benefits, needs to be undertaken to justify the implementation of appropriate measures.

4.1.6.4.1 Pinch technology

Description

The term pinch technology was introduced as a methodology in process design and energy conservation. Nevertheless, it has been developed for use in the areas of water consumption and waste minimisation.

Energy pinch technology is an analysis method that identifies the best use of heat transfer from hot streams, which require cooling, to cold streams, which require heating. A pinch analysis provides a systematic approach to analysing energy networks and improving the energy efficiency of industrial processes. The analysis uses a graphical representation of the energy flows in the process and utility streams to determine the minimum amount of energy and energy system needs to use to satisfy the processing requirements. The technique uses temperature-enthalpy diagrams to characterise the hot and cold streams available for heat transfer. The sum of the hot streams and cold streams in a process can be drawn on a similar diagram from which the pinch temperature can be determined. This information can be used to identify where in the process heat recovery is possible and to what degree. Furthermore, the minimum hot utility requirement and minimum cold utility requirement can be determined. To realise this minimum energy requirement, a heat-exchanger network is installed. The pinch analysis yields the optimum design.

Water pinch technology may be a powerful tool for identifying water re-use, recycling and regeneration opportunities within an installation or process. Water pinch technology uses advanced algorithms to identify and optimise the best water re-use, regeneration and waste water treatment options. The basic concepts are analogous to those for heat recovery. Water flow and the content of water contaminants are taken into consideration, leading to so-called sources and sinks.

Achieved environmental benefits

Reduced energy consumption and associated air emissions. Reduced waste heat released to the air or to water. Maximisation of the re-use of water, taking into account the quality requirements for each application. Minimum fresh water make-up and waste water discharge. Waste minimisation.

Operational data

In an example edible oil refinery, pinch technology was applied to analyse whether a new refining method was more energy efficient than its predecessor, which used steam for process heating and river water for cooling. The analysis revealed that the pinch point was 55 °C and enabled the formulation of a heat recovery strategy. It also revealed that the existing batch processes would lead to a disparity between the timing of heat availability and demand, making it impractical for direct heat-exchange between many of the hot and cold process streams. A heat transfer/storage medium was required before any process integration projects could be carried out. A heat recovery network was developed using water for heat transfer and storage. This proved to be highly successful and did not adversely affect production capacity or flexibility. In addition, the use of the utility system, based on three water temperatures, i.e. 30, 55 and 95 °C, and four thermal tanks, enabled unrelated batch processes to be successfully integrated.

After two years, the edible oil refinery carried out an updated pinch analysis which showed that the pinch point had moved and operational changes were considered. After the pinch analysis, energy consumption was reduced by 35 % and CO₂ emissions by 16700 t/yr. There were also reduced quantities of waste heat discharged into the river.

Applicability

Pinch analysis is successfully applied in the chemical process industry and refineries. It can also be a useful tool for bigger and more complex FDM installations. For relatively simple operations, it does not result in any more or any better options than those that can be raised by the other methods. Also, the method is difficult to apply for batch processes and it does not take into account electricity consumption.

Economics

Table 4.7 shows the costs and savings reported in an example edible oil refinery when applying pinch technology.

Pinch analysis costs (EUR)	
Consultancy fees for the pinch analysis	32000
In-house staff costs for the pinch analysis	16000
Implementation of the pinch analysis recommendations	3066000
Link to neighbouring installation for export of heat	203000
Annual utility water system operating costs	84000
Total costs	3401000
Pinch analysis savings (EUR)	
Savings reduction in energy costs	1145000
Sale of surplus heat	90000
Net savings	1235000

Table 4.7: Costs and savings reported in an example edible oil refinery when applying pinch technology

Driving forces for implementation

Reduction of costs.

Example plants

An edible oil refinery in the UK used pinch technology to reduce its energy costs.

Reference literature

[1, CIAA, 2002, 237, Caddet, 1999]

4.1.6.5 Step 5: Carry out an evaluation and feasibility study

The objective of the evaluation and feasibility study phase is to evaluate the proposed options and to select those most suitable for implementation. The options are all evaluated according to their technical, economic and environmental merits. The depth of the study depends on the type of the option.

Typically, the quickest and easiest method for evaluating the different options is to form a project team, consisting of staff and management personnel, and to discuss the possible options one by one. This process gives a good indication of which projects are feasible and what further information is needed for more thorough evaluations.

Technical evaluation

The potential impacts on products, production processes and health and safety from the proposed options need to be evaluated before actions, which may be complex and costly, can be decided upon. In addition, laboratory testing or pilot tests may be required when options significantly change existing processes.

Economic evaluation

The objective of this step is to evaluate the cost effectiveness of the proposed options. When performing the economic evaluation, the costs of the change are weighed against the environmental benefits and the financial savings that may result. In reality, economic viability is often the key parameter that determines whether or not an option is implemented.

Environmental evaluation

The objective of the environmental evaluation is to determine the positive and negative environmental impacts of the option. In many cases, the environmental advantages are obvious, namely reduced water and energy usage or waste production. In some cases, it may be necessary to evaluate whether, e.g. an increase in electricity consumption would outweigh the environmental advantage of reduced water consumption. An example of a technique with positive and negative environmental impacts, i.e. reducing water consumption and increasing electricity consumption is replacing once-through cooling by a closed-circuit cooling system with refrigeration equipment.

4.1.6.6 Step 6: Implementing the prevention and minimisation programme

Use of an action plan can ensure that the selected options are implemented. The action plan can show the activities to be carried out, the resource requirements, the persons responsible for undertaking those activities and the deadlines for action. It is important to evaluate the effectiveness of the implemented measures and to monitor and review the effects periodically (see Section 4.1.6.7).

An implementation and action plan needs to be prepared and put in place to implement the options. A step-by-step approach is recommended. The action plan needs to include realistic and achievable consumption and emission reduction targets, which senior management have agreed. Involving all staff when implementing the action plan and providing regular feedback to them, helps to keep the momentum going for the programme and to encourage staff to look for future ideas and initiatives. Review progress against targets periodically.

For example, essential steps in setting targets for energy efficiency measures are as follows:

- recording the energy consumption with regular intervals
- relating the energy consumption to production activities and/or other relevant parameters
- introducing targets for energy consumption
- comparing the real energy consumption with the targets
- reporting
- taking action if the real energy consumption deviates substantially from the target consumption.

As setting realistic targets is not always easy, one approach is to set a figure lower than the average level, e.g. 10 % lower. Another approach is to determine the minimum energy consumption level based on the specifications of the various parts of the process lines.

4.1.6.7 Step 7: Ongoing monitoring by measurement and visual inspectionDescription

It is important to evaluate the effectiveness of measures implemented to minimise consumption and emission levels and to monitor and review their effects periodically. The parameters to be monitored depend on the production processes, raw materials and chemicals used in the installation. The frequency at which the parameter is monitored varies widely according to the needs and risks to the environment and according to the monitoring approach taken. Corrective and preventive action can be carried out if a problem is identified. Furthermore, the introduction of new products or processes may also have a positive or negative effect on the consumption and/or emission levels and the techniques for minimising these may need to be adapted.

Monitoring may take a number of forms depending on the individual case and may involve the measurement of physical and chemical parameters and visual monitoring. If it is necessary to monitor ongoing waste water emission levels, measurements will be required. Regular and frequent visual monitoring may supplement water consumption measurements. For example, introducing a routine programme for the visual auditing and handling of water and waste water in the installation may form part of a programme of identifying areas of improvement and maintenance requirements.

Further information on monitoring is available in the “Reference Document on the General Principles on Monitoring” [96, EC, 2003].

Achieved environmental benefits

By ongoing monitoring, the effectiveness of the chosen measure can be periodically checked to see whether it is meeting the set targets, e.g. consumption and emission performance levels. Under performances can thereby be detected and rectified. Also, monitoring shows trends and can identify priority areas for improvement.

Operational data

An example starch manufacturer processes maize into starch, starch derivatives, and glucose, both for food and non-food industries. By carrying out a systematic monitoring and analysis of this process, the company aims to reduce the energy consumption of the installation. The annual savings are equivalent to 3 million m³ of natural gas (95 TJ), i.e. a reduction of approximately 10 %.

Previously, the energy consumption in the starch installation was determined from incidental measurements or from data provided by the energy supplier. The energy use of the separate production stages and their respective products was calculated from these data. This only gave an overview of the actual energy consumption and that was not enough to improve the energy efficiency of the installation. Therefore, a monitoring system that measures and registers the specific energy consumption of several process stages was installed at the site. The production process was divided into separate operational units. Each of the units comprises the manufacture of a particular product or group of products. The energy flows in each module are measured in real-time. The measurements allow the determination of both the energy flows at that time and the consumption over a prolonged period of time.

The new system has made it possible to compare the starch installation’s actual and theoretical energy consumption, allowing optimisation of the process in cases of unfavourable differences. Moreover, the system compares the measured energy consumption with that of comparable process units at sister companies and is capable of changing process units according to the most favourable design.

The new monitoring system continuously measures the modules’ water, steam, natural gas, and electricity flows. The collected data are transferred to a central processor and then converted into tables and graphs, which are distributed among the interested parties.

The system, in its present form, only registers and reports the actual energy consumption of the installation. Calculation of the specific energy consumption, related to the production of the installation, is still performed manually. The analysis of the data is based on comparisons with historic data of energy consumption under similar conditions.

An example UK dairy installed a computer-based monitoring and targeting system to help reduce costs and improve profitability. A number of meters were installed in the dairy to measure electricity, oil and water consumption. The meter readings were entered into the system, which presents data to enable the company to pinpoint areas of waste and to take corrective action. The principle of the system has been well proven in this case, with improvements in energy efficiency constantly being made. Substantial energy and utility savings were achieved. These savings, which were achieved with low capital costs, were partly due to the high motivation of staff at all levels.

Applicability

Widely applicable in the FDM sector.

Economics

The overall investment costs of the starch example installation amounted to EUR 700000. At a gas price of EUR 0.095/m³, the annual savings are EUR 284000. This equates to a payback period of about 2.5 years.

Driving forces for implementation

Reduced costs and improved profitability.

Example plants

A starch manufacturer in the Netherlands and a dairy in the UK.

Reference literature

[1, CIAA, 2002, 96, EC, 2003, 150, Unione Industriali Pastai Italiani, 2002, 181, EC, 2003, 240, CADDET, 1997]

4.1.7 Production management techniques

4.1.7.1 Apply production planning, to minimise associated waste production and cleaning frequencies

Description

Well planned production schedules which minimise the number of product change-overs and consequently the number “interval cleans”, can minimise waste generation, water consumption and waste water generation. If, instead of making the same product twice or more times it can be made in one batch, the number of change-overs can be minimised. The sequence of production may also influence the number of times cleaning is required and the extent.

If an installation produces several different products or the same product, but with different flavours or colours, then depending on the difference between the product specifications and the risk of cross-contamination, equipment and installation cleaning is required between products. This may be important for food safety reasons, e.g. when changing from using ingredients which people may be allergic to, such as peanuts when making ready meals. Also, for flavour and or colour reasons, e.g. when changing yoghurt flavours from blackberry to peach.

If residues have to be removed from equipment between products, it may be possible to use these in by-products or if not they may be disposed of as waste. If the number of change-overs is minimised, the amount of residue removed can be reduced and the overall proportion of raw material which is used in the final product can be maximised. Likewise the amount of water, energy and chemicals used in “interval cleaning” is minimised.

Achieved environmental benefits

Reduced consumption of water, energy and chemicals and generation of waste water and waste.

Applicability

Applicable in FDM installations where the same equipment is used for more than one product and mixing between products has to be avoided for legal, food safety or quality reasons.

Driving force for implementation

Reduced consumption of water, energy and chemicals and generation of waste water and waste and the costs associated with these.

4.1.7.2 Receive materials in bulk

Description

Many materials, whether for direct use in the process or for auxiliary activities such as cleaning agents, may be supplied in bulk, for storage in silos or returnable containers, or for direct use in returnable instead of non-returnable packaging.

Achieved environmental benefits

Avoids the use of some packaging materials and enables the re-use of those used.

Cross-media effects

If empty containers are returned without cleaning, no cross-media effects apply.

Operational data

Many FDM raw materials are delivered by bulk tanker and stored in silos for direct use in the process. These include, e.g. grain, for milling, brewing and animal feed production; flour, for bread and confectionery manufacturing; semolina, for making pasta; sugar for confectionery manufacturing and milk for producing milk, milk powder, butter, cheese, yoghurt and other dairy products. Silo storage is designed so that solid materials received first and fed through the top of the silo are used first from the bottom of the silo. Liquids such as milk are used batch wise. Problems with shelf-life can thereby be avoided by managing the control of receipt, storage and use.

In the FDM industry, chemicals used for cleaning, such as caustic, are widely delivered either by tanker and stored in bulk tanks, or delivered and directly used from intermediate bulk containers. This is especially true where these chemicals are used for CIP, such as in dairies and breweries.

When processing ground meat, spices are often used in pre-weighed lots. They are usually stored in plastic bags, which are discarded after emptying. To minimise the use of plastic packaging materials, spices can be dosed automatically from a bulk container.

Applicability

Widely applicable where bulk ingredients or cleaning materials are used.

Economics

Generally, it is cheaper to buy materials and chemicals in bulk than in small quantities.

Driving force for implementation

Prevention and recycling schemes for waste and packaging waste and legislation on health and safety, to minimise exposure to substances hazardous to health and accidents due to manual handling.

Example plants

Widely applied in the FDM sector, e.g. in grain mills, flour mills, bakeries, confectioners, pasta manufacture and dairies.

Reference literature

[31, VITO, et al., 2001, 41, Nordic Council of Ministers, 2001]

4.1.7.3 Minimise storage times for perishable materials

Description

Raw materials, intermediate ingredients, by-products, products and waste can all be stored for as short a time as possible. Considering their nature, shelf-life, inherent odour characteristics and how rapidly they biodegrade and create an odour nuisance, refrigeration may be used. Processing products as quickly as possible and thereby minimising storage times can increase the quality and yield and, therefore, the profitability of the process.

If stock is minimised to avoid ageing/rotting and materials are processed as quickly as possible, then losses can be minimised. This involves the planning and monitoring of procurement, production and dispatch of materials and finished products, materials destined for downstream users and waste. Rapid use of raw materials or partly processed materials or dispatch can reduce losses due to decomposition and the need for refrigeration. Segregation of waste materials and removal of waste from the installation as quickly as possible can prevent odour problems.

Taking hygiene, food safety, shelf-life and product quality considerations into account, energy can be saved during treatments involving the addition of heat, by removing foods from refrigerated storage in advance of this treatment and allowing their temperature to rise. Likewise, if the temperature of foods destined for cold treatments is not allowed to rise first, energy can be saved during cooling.

Achieved environmental benefits

Reduced waste of raw materials, partly processed materials and finished product. Reduced odour emissions and reduced energy consumption for refrigeration.

Operational data

To optimise material losses and refrigeration requirements requires co-operation between the suppliers of raw materials and other ingredients, as well as auxiliary materials required for the process, such as packaging. There may be contractual arrangements affecting the price paid to suppliers, depending on the quality of, e.g. raw material provided.

Due to fruit and vegetables being soft edible plant products with a relatively high moisture content, they are perishable in their fresh state. Losses can be prevented by processing them immediately, i.e. avoiding storage.

Fish has a highly perishable nature compared to other food products and generally requires either refrigerated storage or storage in ice from the moment the fish are caught, to avoid decomposition and odour emission and to optimise product quality and yield. Product losses also contribute to the solid and liquid waste loads. Quick processing reduces waste, odour and energy consumption associated with refrigeration and ice production. It also allows fish to be used for products which can be sold for a higher price, e.g. for fresh, cured or smoked fillets.

Due to its high perishability, milk is kept in bulk milk coolers at the farm and quick heat treatment and further processing minimises losses.

If partially processed materials are dispatched as soon as possible from one FDM installation to another where they will be further processed, then refrigeration requirements may be minimised at the producer's installation and waste may be minimised at the receiver's installation, by maximising the yield from freshly made ingredients.

Applicability

Applicable to FDM installations handling, storing and processing perishable materials.

Economics

Usually a large proportion of the manufacturing costs within the FDM sector are related to the raw materials. The economic consequences of waste production are not just limited to the actual costs of waste disposal, but to, e.g. raw material losses, production losses and additional labour costs. Minimising refrigerated storage minimises the associated energy costs.

Driving force for implementation

Maximising quality and yield from raw materials, minimisation of waste disposal costs, reduced refrigeration requirements and prevention of odour problems.

Example plants

Widely applied in the FDM sector.

Reference literature

[1, CIAA, 2002, 11, Environment Agency of England and Wales, 2000, 31, VITO, et al., 2001, 134, AWARENET, 2002]

4.1.7.4 Transport solid materials dry

Description

Many raw materials, co-products, by-products and wastes can be transported without using water. This reduces the entrainment of organic matter into water, which would consequently have to be treated in either an on-site or MWWTP, or sent for landspreading.

Achieved environmental benefits

Reduced water consumption. Reduced waste water production and pollution. Increased potential for the recovery and recycling of substances generated in the process which, in many cases, can be sold for use as animal feed.

Operational data

It is reported that bones and fat from deboning and trimming meat materials can be collected and transported dry. These may or may not be intended for human consumption. For example, some deboning stations use a long trough with a screw conveyor under a wide table to transport away fat and meat and a conveyor belt to transport away bones. The segregated fat may then be sent for, e.g. fat melting and the bones for, e.g. gelatine production.

In the fish sector, it is reported that dry transport systems have been applied in different countries, e.g. Denmark and the UK. For example, water can reportedly be saved if the skin is removed from drums by vacuum instead of water. In addition, fine mesh conveyor belts are used to collect wastes and separate them from the waste water, thus decreasing the COD. Other dry transport systems used in this sector include the removal of offal by vacuum or by using conveyors after filleting and eviscerating. The use of dry transport systems is also reported in the processing of crustaceans and molluscs for solid waste collection. For further information see Sections 4.7.2.4 – 4.7.2.6.

In the fruit and vegetable sector, dry transport systems are used for the removal of sorted, untreated or partly treated raw materials, peels and cutting residues. Mechanical conveyors can replace water flumes and where the use of flumes cannot be avoided, water volumes may be minimised. Fluming may be advantageous if it is combined with washing. For example, fluming can be combined with the washing of sugar beets and of potatoes used in starch production and, in addition, these processes use water extracted from the raw material. The fluming water is re-used after treatment to, e.g. remove solid materials such as soil. Fluming may also be necessary for the transport of some fruit and vegetables to avoid mechanical damage during transport, e.g. for tomatoes, peas, artichokes and mushrooms.

Applicability

Applicable in the fish and seafood, meat and fruit and vegetables sectors.

Economics

Reduced water and waste water charges. A higher price can be obtained for the by-product with less water content, e.g. by selling it as animal feed.

Driving force for implementation

Hygiene standards are improved. Reduced water use, reduced need for waste water treatment and lower detergent use and expenditure.

Example plants

Five Danish herring filleting installations and a fish food company in the UK.

Reference literature

[13, Environment Agency of England and Wales, 2000, 28, Nordic Council of Ministers, 1997, 31, VITO, et al., 2001, 58, Envirowise (UK), 1999, 74, Greek Ministry for the Environment, 2001, 134, AWARENET, 2002, 147, Lehman N. and Nielsen E.H, 2002, 181, EC, 2003]

4.1.7.5 Use a waste management team

Description

Waste generation can be minimised by using raw materials efficiently and in parallel with waste separation to recycle materials that might otherwise be sent to the mixed waste stream. Forming a team dedicated purely to the reduction of waste can ensure that the focus on waste minimisation can be maintained, regardless of other issues in the company. This approach can be more effective if applied in addition to the more usual practice of including waste reduction amongst the shift team responsibilities and the quality team objectives. It also sends out a clear message that it is something that the business takes seriously.

For example, the team can get involved in the design of new equipment, such as production lines. This ensures that, right from the design stage, the engineers are looking at ways of reducing waste.

Daily waste figures can be displayed prominently in the installation, showing how operators are performing against the daily target, what the causes of the waste are and what actions are in place to prevent further waste. A weekly report can be sent to senior management, so that they can show leadership on waste when talking to their teams.

It is reported that in an example installation a simple system was set up whereby any incident that created over 2 tonnes of waste was logged by the operators, an investigation carried out and actions put in place to prevent recurrence.

Having to deal with less waste can also improve the hygiene and safety of the waste disposal area.

Further targets for ongoing improvements can be set.

Achieved environmental benefits

Significant reduction in the amount of solid waste generated and consequently the associated environmental impact associated with its disposal.

Operational data

Use of this technique by an example petfood installation led to a 50 % reduction in waste over an 8 month period, which was then maintained. The environmental impact was significantly reduced, together with very significant cost reductions by reducing the loss and waste of raw materials. The waste reduction figures are shown in Figure 4.8.

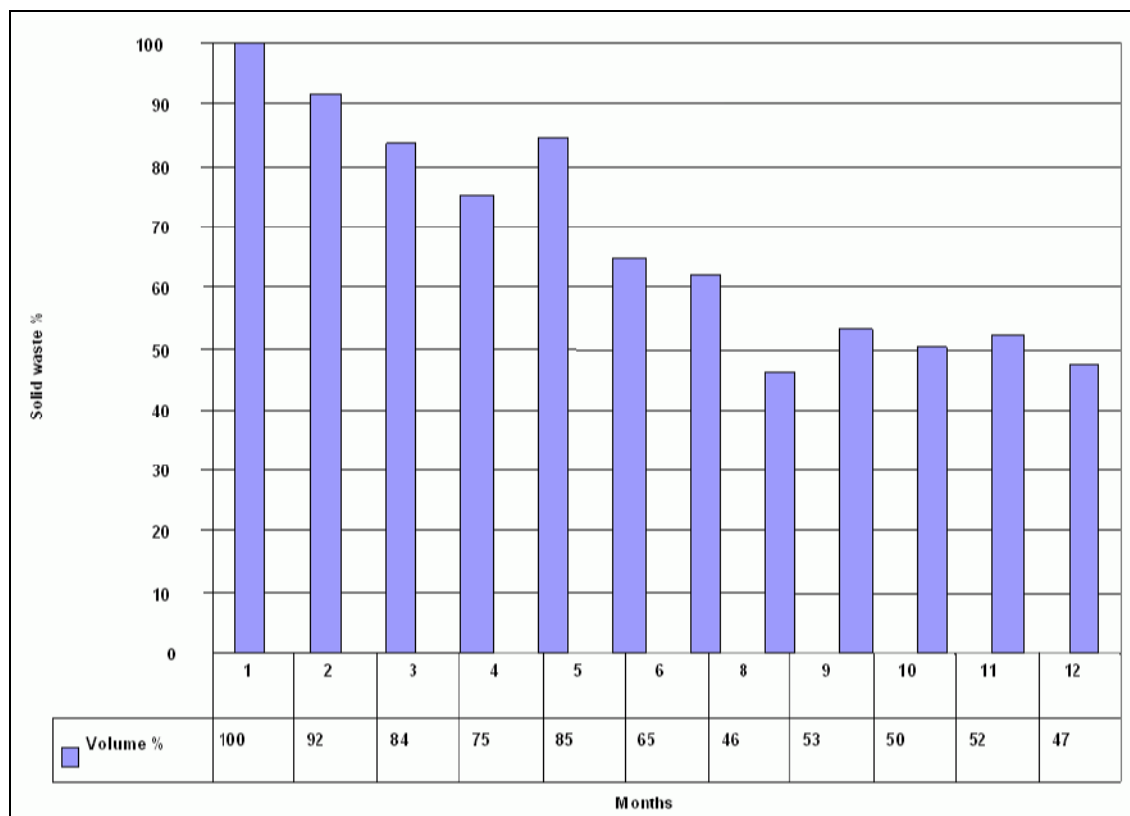

Figure 4.8: Waste reduction in petfood production

In an example installation, the company was just about to embark upon a number of significant asset changes. The significant cost reduction potential was recognised as a good incentive to invest money and start the project. The project was set a challenging target of reducing the amount of mixed solid waste fraction by 50 %. This target was achieved.

Applicability

Applicable to all FDM installations.

Economics

Focusing on taking some simple actions delivered significant cost savings in an 8 month period.

Driving forces for implementation

Significant financial savings by increased use of raw materials in the final product and reduced waste disposal costs.

Example plants

At least one petfood manufacturing company in the UK.

Reference literature

[1, CIAA, 2002]

4.1.7.6 Segregation of outputs, to optimise use, re-use, recovery, recycling and disposal (and minimise water use and waste water contamination)

See also Section 4.3.1.

Description

Outputs, whether or not they are intended for use in the product, can be segregated for optimised and easier use, re-use, recovery, recycling and disposal. This also reduces both the consumption and the contamination of water. It can be done either manually or mechanically. These outputs may include, e.g. rejected raw materials, trimmings and off-specification product.

Accurately positioned splash protectors, screens, flaps, drip trays and troughs can be used to contain individual materials separately. They can be fitted at processing, filling/packing and transfer lines and next to workstations, such as peeling, cutting and trimming benches. The position and design of, e.g. a tray or trough, the means of preventing mixing with water and the transportation of the liquids or solids depend on the unit operation, the degree of segregation of different materials desired or required and their ultimate intended use, or disposal route.

Examples of materials which can be collected and transported dry include bones and fat from deboning and trimming meat. These may or may not be intended for human consumption. For materials destined for human consumption, temperature control is particularly important and deterioration can be avoided by quickly transferring the materials to chills.

Other examples include removal of sorted, untreated or partly treated fruit and vegetable residues, peel and cutting residues and collecting spent earth in sedimentation and filtration steps instead of washing it into the WWTP.

Where the amount of potential waste is high, manual or automated collection systems such as drains, pumps or suction devices can be installed, to minimise deterioration and maximise potential use, e.g. in animal feed. This also mitigates against the possibility of materials being washed into the WWTP during interval cleaning.

In the dairy industry, examples of materials which can be collected separately for optimal use or disposal include the drainings of yoghurt and fruit throughout the dairy; first rinses of buttermilk and residual fat in butter churning operations, for use in other processes, e.g. for low fat spreads and whey, e.g. for making mitzithra cheese (see Section 4.7.5.1).

In vegetable oil refining, dust produced during drying of desolventised meal can be added back to the meal (see Section 4.7.4.10).

Some water diluted materials can be recovered, if the water is collected, e.g. potato starch can be recovered from starch water, as described under *Operational data* and whey can be extracted from whey/water mixtures. This can be optimised by using turbidity meters (see Section 4.1.8.5.3).

Additionally materials can be recovered for use or disposal by using dry cleaning methods (see Section 4.3.1).

Achieved environmental benefits

Reduced water consumption and less entrainment of materials in water, so generation of less waste water. If materials are collected efficiently, the volume of water required for cleaning is reduced and consequently less energy is used to heat the cleaning water. Less detergent is also required. The waste water load of, e.g. BOD, COD, nutrient and detergent levels are all reduced, per unit of production.

The segregation of liquids and solids destined for use or destruction has several advantages. If sufficient separate collection systems are provided, it reduces cross-contamination between different by-products. Segregation of by-products reduces potential odour problems from materials which, even when fresh, emit the most offensive odours, i.e. by storing/removing them separately under controlled conditions, instead of having to control a greater volume of mixed by-products.

Also, by minimising cross-contamination, segregation enables individual by-products which can be used to be used, instead of being disposed of because they are mixed with materials which cannot be used. All materials can, therefore, be used or disposed of in the most appropriate way for them.

Operational data

The following examples show how segregation can result in cleaner waste water, reduced water consumption and reduced waste.

In fish processing, using baskets or trays at cutting, eviscerating, skinning, and filleting can avoid the solid wastes reaching the floor and then the waste water. Fine mesh conveyor belts can be used to separate waste and water at cutting and evisceration stations and can reportedly decrease COD levels by about 40 %. The collected solid materials can be used to make fish-meal.

Dry systems have been developed for collecting solid waste from crustaceans and molluscs. Screens and efficient systems for the recovery of solids, prevents them from entering the WWTP and can reportedly lead to BOD₅ level reduction of up to 35 %.

In an example installation producing snack foods, waste water streams were segregated prior to on-site treatment and then treated to remove solids and oils, which were then processed into animal feed cake. This was as a result of a “water action group” consisting of managers, shift operators and the site adviser using a bucket-and-stopwatch approach to study the ideal flowrates for each piece of equipment. The results of this water audit showed that substantial savings could be made. Three main waste streams were identified, i.e. potato wash-water, cold starch water and hot starch water containing oils.

In fruit and vegetable processing, solid organic material from the peeling process and from blanching can be separated using, e.g. sieves, filters or centrifuges, to prevent them from entering the WWTP. Normally these solids, except after caustic peeling, can be used as animal feed.

In starch manufacture, potato wash-water can be re-used after grit is removed. Cold starch water can be recycled after the good quality starch has been recovered. Water recycling and re-use have reportedly reduced water consumption by 19 %, i.e. 165000 m³/yr.

Applicability

Applicable to all FDM installations.

Economics

The 165000 m³/yr reduction in water consumption at the example snack food installation saved a reported EUR 145000 in water supply costs.

Driving force for implementation

Reduced waste because materials recovered can be used. Reduced waste water treatment and waste disposal and the associated reduced costs.

Example plants

At least one snack food installation in the UK. Dairies in the UK and fruit and vegetable processing plants in Belgium. Widely applied in drinks manufacturing, e.g. in winemaking.

Reference literature

[1, CIAA, 2002, 17, Envirowise (UK) and March Consulting Group (UK), 1998, 31, VITO, et al., 2001, 45, Envirowise (UK) and Ashact, 2001, 75, Italian contribution, 2002, 134, AWARENET, 2002]

4.1.7.7 Use of by-products, co-products and residues as animal feed

Description

Numerous examples exist in the FDM sector where raw materials, partially processed foods and final products either originally intended for human consumption or from which the part intended for human consumption has been removed, may be used as animal feed. For example, foods which are slightly outside the customer specification, or which have been over-produced, may be suitable for use as animal feed.

Production of animal feed from, e.g. sugar beet pulp, apple and tomato pomace and citrus pulp pellets, without or after treatment is limited by several factors, including putrefaction during storage and transport, and the presence of undesirable constituents such as alkalis or salt. Water content is the major contributor to shipping costs and, to some extent, the putrefaction rate.

Achieved environmental benefits

Increased use of materials and reduced waste generation. Consequently there is an associated reduced consumption of, e.g. energy for waste treatment and disposal, e.g. in WWTPs and reduced landfilling of FDM waste.

Cross-media effects

Some materials may need to be stored in controlled temperature conditions, if it is not possible to use them before they start to degrade and become no longer suitable for use as animal feed.

Applicability

Applicable in FDM installations using raw materials and partially processed ingredients and producing products which are suitable and fit for consumption by animals either directly or after further processing and which comply with relevant legislation governing animal feed.

Economics

Reduced purchase of materials which are not used and sold and reduced waste treatment and disposal costs.

Driving force for implementation

Economic use of by-products, off specification products and excess materials, which would otherwise be sent for disposal as waste.

Example plants

Examples of sources of animal feed from FDM processes manufacturing for human consumption are shown in Table 4.8.

Source of animal feed	Example industry source
Bones and fat	Meat processing (subject to Regulation 1774/2002/EC [188, EC, 2002])
Rejected fish	Fish processing
Stalks, hulls and leaves	Fruit and vegetable processing
Fruit and vegetables, such as peel, cores and cutting residues	Fruit and vegetable processing
Apple and tomato pomace and citrus pulp pellets, without or after treatment	Fruit and vegetable processing
Crude olive cake (also called pomace)	From the first pressing of olives
Olive cake	From extraction of pomace oil (olive)
Recovered ffas	Vegetable oil processing
Toasted meal	Vegetable oil processing
Crude cake and spent meal/cake	Vegetable oil processing
Phospholipids	Vegetable oil refining
Spent bleaching (in the absence of a nickel catalyst)	Vegetable oil refining
Product retrieved from wrongly filled containers, e.g. by maceration of packaging	Dairies, but applicable to all FDM industries producing foods suitable for use in animal feed
Leaked and spilt ingredients and partly and fully processed materials	Dairies, but applicable to all FDM industries producing foods suitable for use in animal feed
Rinsings from yoghurt vats	Dairies
Whey which is not intended for making mitzithra cheese, baby food or other products	Dairies
Milky waste water generated at the start-up of pasteurisers	Dairies
Cereals, fibre, gluten, vegetable protein and de-fatted meal	Cereals processing
Wet pulp and pressed pulp from the pressing of cossettes	Extraction of sugar from sugar beet
Vegetable matter separated from sugar beet fluming water	Extraction of sugar from sugar beet
Molasses	Sugar extraction
Vinasses produced during the processing of alcohol from sugar beet molasses	Molasses distillation
Distiller's dried grains with solubles (DDGS)	Maize distillation
Recovered strong liquors	Drinks manufacturing
Malt	Beer, lager and whisky production (from germinated kiln-dried grain)
Husk and malt grits, which may be mixed into brewers' grains and trub	Breweries
Concentrated or dried stillage, pot ale, spent lees and spent wash	Whisky stills
Fermentation vessel cooling water containing raw materials and fermented produce residues	Whisky distilleries
Brewers' yeast	Fermentation
Solid organic such as raw material and product residues and dust	Dehydration
Solids and oils removed from segregated waste water streams	Snack foods manufacturing

Table 4.8: Examples of sources of animal feed from FDM processes manufacturing for human consumption

Reference literature

[1, CIAA, 2002, 10, Environment Agency of England and Wales, 2000, 13, Environment Agency of England and Wales, 2000, 31, VITO, et al., 2001, 65, Germany, 2002, 84, European Starch Association, 2001, 134, AWARENET, 2002, 141, FEDIOL, 2002, 161, Verband Deutscher Oelmuehlen, 2003]

4.1.7.8 Segregation of water streams to optimise re-use and treatment

Description

There are generally four types of water streams present in an FDM installation, i.e. water directly associated with use in the process, domestic/sanitary waste water, uncontaminated water and surface water. A water segregation system can be designed to collect these water streams and separate them according to their characteristics, e.g. their contaminant load.

When it is feasible to do so, and it will not affect food safety, the uncontaminated water streams can be re-used for specific process applications, e.g. washing, cleaning, make-up for utilities, for sequential re-use, and exceptionally, for the process itself. Uncontaminated water for which there is no re-use opportunity available can generally be discharged without treatment and doing so prevents an unnecessary burden being imposed on the WWTP.

Contaminated waste water may be segregated to receive appropriate treatment according to its characteristics. It may then be possible for the high volume, low strength streams to be either recycled following suitable treatment, discharged directly to the MWWTP without treatment, or be mixed with treated waste water prior to discharge.

In some cases, materials can be recovered from process water for use in the process or for other uses such as animal feed (see Sections 4.1.7.6 and 4.1.7.7).

Achieved environmental benefits

Reduced water contamination, by keeping clean water separate from dirty water and consequently also reduced energy consumption associated with the waste water treatment because not all of the waste water is subjected to every treatment. The re-use of water reduces water consumption and consequently also generally results in a reduction of emissions. It can also enable heat to be recovered.

Operational data

Reported opportunities for the re-use of water include:

- use of water that has not been contaminated in the process where water of non-drinking water quality is required
- in dairies, cooling water, condensates generated in evaporation and drying operations, permeates generated in membrane separation processes and cleaning water can be re-used
- in fruit and vegetables installations, water is re-used, either directly in a unit operation or indirectly as a source, e.g. either heat or cold
- sequential re-use, where water can be used for two or more processes or operations before disposal, e.g. using gluten process water in protein separation steps for germ and fibre washing, steeping processes in maize starch processing, or using evaporator condensate for sugar extraction from sugar beets
- recycling within a unit process or group of processes without treatment
- recycling with treatment
- condensates produced during evaporation may be re-used in the process depending on their quality, e.g. content of organic and/or inorganic matter and SS. Steam condensate may be used as boiler feed-water. This leads to recovery of a considerable amount of heat, as well as savings in the use of chemicals for the treatment of boiler feed-water. If condensate is re-used this can be optimised by maximising the condensate return and avoiding losses of flash steam from condensate return
- water which has not been in contact with the product, such as cooling water from refrigeration systems, some condensate and RO water which has been contaminated slightly can be used for cleaning less sensitive areas, e.g. yard washing, or for the preparation of cleaning solutions. It is reported that the re-use of cooling water for other purposes may not be possible if it contains biocides.

Applicability

Some water re-use opportunities exist in existing FDM installations. Segregation of waste water is applicable in new and substantially altered existing FDM installations. For new installations, the waste water segregation system can be designed so that different types of waste water are separated. For existing installations, this may not be possible due to the costs involved and the physical or engineering constraints at specific sites.

Economics

For segregation of waste water there is a high capital cost, however, this may be offset by the reduced running costs due to the lower requirement for waste water treatment, whether on-site, at a MWWTP or a combination of both. It may not be economical to segregate small, isolated streams. Reduced costs associated with water consumption and in some cases with reduced energy consumption.

Driving force for implementation

Reduction of long-term expenses for treating waste water. Moreover, by segregating low strength streams, a treatment facility can be reduced in size. Reduced water and energy consumption.

Example plants

Used in the fruit and vegetable; dairy; sugar; drinks and brewing sectors. The technique is also used in at least one snack food installation in the UK (see Section 4.1.7.6).

References to literature

[13, Environment Agency of England and Wales, 2000, 42, Nordic Council of Ministers, et al., 2001, 52, Envirowise (UK), 2000, 75, Italian contribution, 2002, 94, Environment Agency of England and Wales, 2002, 134, AWARENET, 2002]

4.1.7.9 Minimise heating and cooling times

Description

The times for heating and cooling processes can be optimised to minimise the energy consumed. This can be done in a variety of ways, e.g. by using a pretreatment, by stopping the operation as soon as the required effect is required and by selecting equipment which can achieve the required effect with the minimum energy consumption.

Achieved environmental benefits

Reduced energy consumption.

Operational data

Examples of pretreatments that minimise heating times are soaking vegetable seeds such as lentils (see Section 2.1.4.1) and drying potatoes before frying, in the preparation of potato chips (see Section 2.2.3.8.1).

Stopping the operation when the required effect is achieved includes not cooking ingredients for longer than is needed, e.g. when baking bread or boiling wort in brewing (see Section 4.7.9.6) or not cooling foods to colder temperatures than those needed either for processing or storage (see Section 4.2.15.1).

Examples of minimising heating times by equipment selection include direct heating during baking (see Section 2.1.5.4) and using fluidised bed driers (see Section 2.1.6.3.3), e.g. for coffee roasting (see Section 2.2.13.1).

Applicability

Applicable where heating and cooling operations are carried out.

Driving force for implementation

Reduced energy consumption and associated costs.

4.1.7.10 Optimise start-up and shut-down procedures and other special operating situations

Description

Start-up and shut-down procedures and other special operating situations can be optimised. For example, by minimising the numbers of start-ups and shut-downs, waste gases from purge vents or preheating equipment, can be minimised. The emission peaks associated with start-up and shut-down can be avoided and consequently, the emissions per tonne of feedstock are lower. This also applies to the operation of abatement equipment.

Achieved environmental benefits

Depending on the application reductions in the consumption of energy; waste generation and emissions to air and water can be achieved.

Operational data

In air abatement, e.g. waste gas thermal oxidisers do not operate effectively until they reach the combustion temperatures of the pollutants they are used to destroy, so they need to be started up before they are actually required (see Sections 4.4.3.11.1 and 4.4.3.11.3)

Driving force for implementation

Reduced consumption and emission levels.

Reference literature

[65, Germany, 2002]

4.1.7.11 Good housekeeping

Description

Enforcing a system to maintain the installation in a clean and tidy manner can improve the overall environmental performance. If materials and equipment are kept in their allocated place then it is easier to ensure that use-by dates are respected and less waste is generated. It is also then easier to clean the installation and reduce the risk of infestation by insects, rodents and birds. Spillages and leaks can be actively minimised and spilled materials can be collected dry immediately.

Achieved environmental benefits

Reduced waste generation, reduced contamination of waste water by wet cleaning, reduced odour production and emission and reduced risk of infestation by insects, rodents and birds.

Applicability

Applicable to all FDM installations.

Economics

Avoids expenditure on odour abatement, waste disposal and waste water treatment.

Driving force for implementation

Reduced waste production and safety (prevention of slipping and tripping accidents).

4.1.7.12 Manage on-site vehicle movements

Description

By controlling the times when vehicles enter and leave the installation and the location and times of on-site vehicle movements, noise emissions off-site can be reduced at sensitive times, e.g. at night during the hours when neighbours, in residential areas, normally wish to sleep.

This may be optimised further by the selection of quiet vehicles, including those that are well maintained and providing road surfaces with low noise transmission qualities.

Achieved environmental benefits

Reduced noise emissions at night.

Cross-media effects

Increased noise and vehicle emission levels during the daytime.

Operational data

For some FDM processes which practice 24 hour processing, the importance of receiving materials fresh for rapid processing may limit the possibilities to restrict deliveries to daytime. This restriction may apply to, e.g. fruit and vegetable processing when harvesting and processing of, e.g. tomatoes and peas is undertaken during 24 hours/day, to ensure ripeness and taste.

It may be difficult to limit the arrival and departure times of shift workers to avoid times when noise may cause a nuisance to residential neighbours.

Noise levels were measured in the neighbourhood of an example large brewery operating for a full 24 hours a day on working days. Noise levels attributed to the brewery were measured at identified nearest immission detection sites. In addition, calculations were made of the noise levels at the nearest immission detection sites caused by traffic to and from the brewery, such as incoming raw materials, e.g. malt and outgoing products; by-products and waste, e.g. bottled and canned beer; yeast and brewery residues; and within the installation, e.g. forklift trucks and cars. Traffic to and from the brewery is limited to daytime hours.

Six parcels of land were considered as immission detection sites. With the exception of one site which contained storage and workshop buildings, the parcels of land were not built on.

The measurements of the immissions attributed to the brewery at the nearest immission detection sites are shown in Table 4.9. The noise sources used were the fans and compressors and brief blow-off noises from valves.

Measuring site*	L _{AFm} (dB(A))	L _{AF95} (dB(A))	Noise source
1 (distance of 100 m)	43.3	42.0	Fans of waste water system
2 (distance of 110 m)	48.0	46.5	Fans of CIP system, roof fans
3 (distance of 75 m)	49.7	48.0	Fans of CIP system, roof fans
4 (distance of 120 m)	48.6	46.0	Fans of CIP system, compressor unit
5 (distance of 110 m)	45.8	44.5	Compressor unit
6 (distance of 110 m)	46.9	45.5	Compressor unit
L _{AFm} = the maximum noise level measured/read on the noise meter, during the time under consideration			
L _{AF95} = the noise level measured in dB(A), exceeded for 95 % of the time under consideration			
*The measurement period was 1.5 – 10 minutes. The values are an average from 3 measurements			

Table 4.9: Noise measurements (mean of three independent measurements) from a German brewery

The measurements in Table 4.10 show the noise emissions calculated for daytime and night operation from internal site traffic and supplier traffic.

Site	Partial rating level – night (dB(A))	Partial rating level – day (dB(A))	Rating level (dB(A))	
			Day	Night
1	43.5	52.9	53.7	46.4
2	41.2	51.0	53.7	49.0
3	30.9	44.3	52.8	49.7
4	24.4	37.3	51.2	48.6
5	31.7	41.7	49.1	46.0
6	35.9	44.9	50.1	47.2

Table 4.10: Calculated partial rating levels for materials transport and transhipment processes

When calculating the daytime rating levels, the values in Table 4.9 were raised by a rest period (06.00h – 07.00h and 20.00h – 22.00h) mark-up of 2.4 dB(A). The measured values at all six sites were well below the local immission guide value during the day and also complied with the immission guide value during the night.

The concentration of vehicle movements during the day can have mixed occupational safety implications. During the day visibility may be better, but there may be more people on the site and together with the additional concentration of vehicles, the management of vehicle movements and the segregation of vehicles from people is a very high priority.

There may be off-site implications in terms of traffic congestion by limiting the hours of reception and dispatch from any site.

Applicability

Applicable in virtually all FDM installations.

Driving force for implementation

Good relations with neighbours and the elimination of complaints about off-site noise levels.

Example plants

At least one brewery in Germany.

Reference literature

[65, Germany, 2002]

4.1.8 Process control techniques

The benefits of improved process control include an increase in saleable product, improved quality and reduced waste.

Improving the process control of inputs, process operating conditions, handling, storage and waste water generation can minimise waste by reducing off-specification product, spoilage, loss to drain, overfilling of vessels, water use and other losses.

To improve process control, it is important to identify at which stage in the process waste is generated, what is the cause of that waste and what improvements can be made to reduce the waste. For example, fitting a level switch, float valve, or flow-meter can eliminate waste caused by overflows. The degree of maintenance cleaning and calibration of all such devices will vary depending on their design and the frequency and conditions of their use.

It is vital that the process monitoring and control equipment is designed, installed and operated so that it does not interfere with hygiene conditions in the production process, and does not, in itself, lead to product loss and waste. Further information about monitoring is available in the “Reference document on the general principles of monitoring” [96, EC, 2003].

4.1.8.1 Control temperature, by dedicated measurement and correction

Description

Raw material waste and waste water generation can be reduced by controlling the temperature, e.g. in storage vessels, processing vessels and transfer lines. Possible benefits from this include reduced deterioration of materials, reduced out-of-specification products and less biological contamination. The application of temperature sensors can sometimes be optimised by using them for dual purposes, e.g. for monitoring both product and cleaning temperatures.

Achieved environmental benefits

Reduced energy consumption and reduced waste generation. Potentially reduces water consumption, if water or steam are used for heating.

Operational data

It has been reported that in dairies, the temperature of the milk can be maintained during heat treatment by controlling the flow of steam or hot water.

In confectionery manufacture, temperature sensors can be used to minimise the temperature drop during product transfer, thereby minimising product deterioration.

In meat processing, the temperature of thawing baths for frozen meat can be maintained by controlling the water flow.

In an example meat processing company, installing thermocouples to provide temperature control allowed it to reduce its water supply costs by up to 10 %. Thermocouples on the water inlet and outlet to a chilling and washing system, feed into an automated control valve which optimises the flowrate. The control system has reduced water use, energy use and waste water generation significantly, while maintaining sufficient flowrate to meet the process's hygiene requirements.

A company fermenting molasses to produce alcohol installed an improved temperature control in a fermentation vessel, which was regularly exceeding the required temperature by 5 °C. The result was increased production yields and a 15 % reduction in waste.

Applicability

Applicable in installations where heat processes are applied and/or materials are stored or transferred at critical temperatures, or within critical temperature ranges.

Economics

In the example where thermocouples were used, the company reported savings of GBP 13000/year for an initial investment of GBP 3000, giving a payback period of 12 weeks (2000). Savings can be achieved due to increased production yields and reduced waste generation.

Driving force for implementation

Minimisation of product deterioration, increased production yields and reduced water consumption.

Example plants

Applied in dairies, confectionery manufacture, at least one meat processing installation in the UK and at least one molasses fermentation installation in the UK.

Reference literature

[18, Envirowise (UK) & Entec UK Ltd, 1999]

4.1.8.2 Control flow or level, by dedicated measurement of pressure

Description

Pressure or vacuum may be applied in several operations, e.g. in filtering, drying, fermenting, autoclaving.

Pressure control can typically be applied, using pressure sensors for the indirect control of other parameters, eg flow or level. Using pressure sensors in transfer lines to control pump speed pressure and flow velocity, and to minimise waste from material damaged by shear or friction forces. Using a differential pressure system to monitor levels in storage or reaction tanks to minimise material loss from overflow or production downtime due to lack of stock. Using a differential pressure system to monitor pressure drops across filters, to control cleaning cycles and optimise operation and thereby minimise waste.

Pressure sensors used in FDM applications generally require seals and surfaces designed specifically for hygienic applications.

Achieved environmental benefits

Minimisation of waste.

Operational data

In an example fruit juice installation, the product is filtered to remove fruit pulp solids before bottling. Filter cleaning with a water sparge was initiated at regular intervals according to a timer. The company recognised that this resulted in the filters being cleaned more frequently than was necessary. Differential pressure sensors were installed on three filter units and the cleaning cycle is now initiated by a signal from these sensors. This signal is given when a preset pressure across the filters is reached. Water consumption for filter cleaning has fallen by 30 %.

In an example dairy, pressure measurement is used in monitoring and controlling flow velocities in pipelines, via pump controls, to avoid friction damage to the product.

In an example brewery, pressure measurement is used in monitoring and controlling the water pressure for spraying water of the malt in the mash filters, i.e. sparging.

Applicability

Applicable in installations where fluids flow or are pumped, such as in the drinks and milk sectors.

Economics

At a reported fruit juice installation, the reduction in water consumption for filter cleaning has resulted in a saving of GBP 8000/yr in water consumption and waste water treatment costs. The cost of the modifications was GBP 6000, so the payback period was 9 months.

Example plants

A fruit juice installation, a dairy and a brewery in the UK.

Reference literature

[18, Envirowise (UK) & Entec UK Ltd, 1999]

4.1.8.3 Level measurementDescription

The two main categories of level sensors are level-detecting sensors and level-measurement sensors. Level-detecting sensors indicate whether or not a fluid is present at a specific point in a vessel (usually a high or low point). Most applications are connected to a visual indicator, a visual or audible alarm, or on-off control of flows in or out of the vessel. Level-measurement sensors allow continuous monitoring of actual fluid levels, with associated variable controls, e.g. increasing or slowing pumping rates.

Achieved environmental benefits

Reduced consumption of cleaning materials and water; reduced generation of waste water and reduced risk of contamination of soil, surface and groundwater.

Operational data

At an example brewery, a capacitance level switch is used to detect the interface between yeast and beer. The beer was then run off to storage. Yeast can be recovered and used as animal feed (see Section 4.7.9.3).

In beer making, every 1 % of wort going to drain adds about 5 % to the waste water COD, this can be avoided by using level sensors to prevent overfilling of process vessels with very high COD levels.

An example large vegetable processing company made savings through reduced water costs, waste water charges and operator time by installing level controls on the water supply tanks to the flume system that transported the vegetables. Previously, an operator adjusted the water supply controls manually, which led to excessive water overflow from the tanks when the operator was occupied elsewhere. A simple float valve was identified as offering a low cost solution. The valve now controls the water flow to the tanks, freeing the operator to work elsewhere.

Applicability

Widely applicable in the FDM sector, e.g. where liquids are stored or reacted in tanks or vessels, either during manufacturing or cleaning processes. Table 4.11 shows some examples of how level sensors can be used to reduce material waste and waste water generation.

Installation	Reason for control
Storage or reaction tanks	Prevent overflow and waste of material or water
Storage vessels	Provide information for stock control. Minimise waste from out-of-date stock or production losses due to material not being available
Vessels with automatic transfer controls	Minimise waste from transfer losses or inaccurate batch recipes
Liquid food materials	To monitor the level in storage tanks to avoid overfilling and loss to drain
CIP/sterilisation-in-place	As a level switch in vessel cleaning to optimise the amount of water/detergent used and to protect against overspill

Table 4.11: Examples of use of level sensors in FDM processing

Economics

In the example brewery, the process modifications cost GBP 9500 (1999), but the associated reduction in beer losses and waste water charges worth GBP 800000/year, meant the payback period was 5 days.

The example vegetable processing company saved over GBP 15000/year through reduced water costs, waste water charges and operator time. The payback period was a few months.

Driving force for implementation

Expensive loss of product.

Example plants

Widely applicable in the FDM sector.

Reference literature

[1, CIAA, 2002, 11, Environment Agency of England and Wales, 2000, 13, Environment Agency of England and Wales, 2000, 18, Envirowise (UK) & Entec UK Ltd, 1999]

4.1.8.4 Flow measurement and control

Description

Flow measurement and control techniques can reduce material waste and waste water generation in FDM processing. Applying flow measurement and control in transfer lines allows the accurate addition of materials to storage and processing vessels and filling packaging, thereby minimising the excessive use of materials and the formation of out-of-specification products.

Flow-meters with no internal measuring element, e.g. electromagnetic meters, are particularly suited to hygienic applications. To reduce contamination, flow-meters need to be robust and easy to clean. In processes where fluids may solidify at low temperatures, heat tracing may be required to ensure that the fluid does not solidify in or around the equipment. There are various types of flow-meters available, e.g. rotameters, positive displacement meters, electromagnetic flow-meters, ultrasonic transit time meters and vortex shedding meters. Each type has particular installation requirements to ensure that they measure accurately.

In CIP systems, flow measurement can control and optimise the water use, thereby minimising waste water generation.

The control of clean and purge interfaces is important, because it can contribute to significant losses. By using flow or conductivity controls, e.g. water/milk interfaces are accurately detected to minimise the amount of raw milk lost to drain. Pigging can also be used to control interfaces (see Section 4.3.3).

Achieved environmental benefits

Reduced waste of materials, products and water and less waste water generation.

Operational data

When processing ground meat, the water flow to sausage fillers and similar equipment can be minimised. The water flow is stopped automatically when the equipment is not used at breaks or production stops.

In an example dairy processing 3000 m³ of raw milk a week, 0.2 % of waste milk was saved by optimising the water/milk interface through flow-meters and conductivity probes. The final site waste water COD reduced from 3100 to 2500 mg/l.

In a vegetable processing company, manual flow control valves were installed on the water supply to the conveying system. This allowed the operators to make sensitive adjustments to the water flow. In addition, a particular valve setting and water flowrate could easily be repeated.

A confectionery manufacturer found that there was considerable variation in the weight of chocolate coating on its products. A number of measures were implemented to improve the control of chocolate addition. These included installation of an electromagnetic flow-meter and a control valve to control the chocolate feed rate accurately. Consumption was reduced by 10 t/yr.

A company manufacturing ready-made meals installed a positive displacement meter to increase its understanding of water use in the equipment cleaning bay. After several weeks of monitoring, it became clear that water consumption varied significantly and that it was not related to production levels. Following discussions with the operators in the area, improved cleaning procedures were introduced. The result was an immediate reduction in water use of 80 m³/week.

It is reported that in drinks manufacturing, the volume of liquid can be metered to containers, instead of filling them to their full capacity.

Applicability

Widely applicable in the FDM sector. Examples of the general applicability of flow measurement and control is shown in Table 4.12.

Equipment	Condition/activity	Reason for control
Transfer lines	Accurate addition of materials to reaction vessels	Minimise excessive use of materials and formation of out-of-specification products
Steam supplies	Maintaining correct operating temperatures	Minimise waste from underheated or overheated materials and products
Cleaning systems	Water use	Optimise use and minimise waste water generation

Table 4.12: Examples of the use of flow control in the FDM sector

Some typical applications of flow measurements are shown in Table 4.13.

Product/activity	Application
Soft drinks	Flow measurement and feedback control for raw material addition
Bulk solids	For example, determining the flow of potato crisps to a flavour drum to ensure the correct ratio of flavouring
Milk powder	Flow measurement for accurate batching of ingredients into the process as specified in recipes
CIP	Flow measurement to ensure a fixed volume of water issued for each cleaning stage

Table 4.13: Typical applications of flow measurements in the FDM sector

Economics

In the example dairy, raw milk and waste water savings were GBP 88640/year.

In the vegetable processing example quoted above, with the valves set for the optimum flow rate, the company saved about GBP 18000/yr in water and waste water costs. The payback period was 3 months.

In the confectionery company, the modifications cost GBP 7500 to implement, but the reduction in chocolate consumption was worth GBP 15000/yr, giving a payback period of 6 months.

The improved management of water use in the ready-made meals company resulted in savings of GBP 3000/yr in water and waste water costs, giving a payback of 10 weeks on the GBP 600 that was paid to install the meter.

Driving force for implementation

Reduced waste of materials and water and the associated cost savings. Reduced extra quantities provided and associated cost savings.

Example plants

Flow measurement and control is widely applied in the FDM sector.

Reference literature

[11, Environment Agency of England and Wales, 2000, 18, Envirowise (UK) & Entec UK Ltd, 1999, 41, Nordic Council of Ministers, 2001]

4.1.8.5 Analytical measurement

To minimise wastage and to check the quality of materials, the pH, conductivity and turbidity of a range of fluids are commonly checked in-line.

4.1.8.5.1 pH measurement

Description

pH probes measure the acidity or alkalinity of a liquid. pH is important in many applications, e.g. controlling milk quality; monitoring cream and cheese ripening; fermentation processes; the production of baby foods and treatment of both water and waste water.

The probes can be fixed permanently into a process line or dipped manually into tanks or storage vessels. Various devices are available. These range from simple probes and transmitters to self-diagnostic probes that alert operators to equipment faults and can be maintained and calibrated without removal.

Achieved environmental benefits

Reduced consumption of acids and alkalis and consequent reduced waste water generation. Reduced waste of process materials, due to inappropriate mixing during processing and cleaning.

Operational data

To avoid spurious readings, the fluid velocity should not exceed 2 m/s and the electrode should always be “wetted” first to avoid loss of function.

An example confectionery company uses a pH probe to control caustic dosing of a waste water stream. As well as ensuring compliance with its discharge consent, pH control helps to minimise the potential for expensive corrosion in the drainage system due to acid or alkaline attack.

Applicability

Applicable to all FDM installations where acid and/or alkali materials are added to process, cleaning or waste water streams. Examples of the use of pH measurement in the FDM sector are shown in Table 4.14. Typical applications of pH measurement in the FDM sector are shown in Table 4.15.

Activity	Reason for control
Control of additions of acid or alkali to reaction vessels	Minimise waste from overdosing and production of out-of-specification product
Monitor waste water streams for use in mixing and neutralising prior to discharge	Minimise use of fresh caustic or acid for waste water treatment

Table 4.14: Examples of the use of pH measurement in the FDM sector

Sector/activity	Application
Dairy	pH analysis of milk deliveries to minimise losses through mixing of unsuitable milk with other raw materials
Jam production	pH measurement to identify correct gelling point

Table 4.15: Typical applications of pH measurement in the FDM sector

Driving force for implementation

Reduced consumption of acids and alkalis, e.g. in CIP and reduced waste generation.

Example plants

Dairy and jam making and waste water treatment.

Reference literature

[11, Environment Agency of England and Wales, 2000, 18, Envirowise (UK) & Entec UK Ltd, 1999]

4.1.8.5.2 Conductivity measurement

Description

Conductivity measurements are used to determine the purity of water or the concentration of acid or alkali, i.e. by determining the sum of the ionic components of the water. Electrode cells and inductive sensors are two types of sensors used to measure conductivity.

Electrode cells are contact-type sensors, which operate by passing the process fluid between two electrode plates. They are reported to be very accurate. Applications include monitoring process water for re-use, thereby minimising waste water generation and monitoring boiler water to minimise the build-up of deposits on hot surfaces.

Conductivity can also be measured using **inductive sensors**. These non-contact sensors use two electromagnetic coils around the process fluid and are suitable for hygienic applications. Inductive sensors have a greater range than electrode cells.

Achieved environmental benefits

Reduced water and detergent use and reduced quantities of waste water.

Operational data

Although fluid flow is not essential, it provides a self-cleaning effect. Air pockets should be avoided. The equipment should be able to compensate for the change in the conductivity of a fluid with temperature.

See also Section 4.1.8.4.

At an example dairy (Example A), the CIP cycle comprises a water flush to rinse out residual product; cleaning using acid or caustic detergent for a set period, followed by a water rinse. These stages were previously controlled by individual timers to limit the amount of detergent used. A number of lines and vessels are cleaned by each CIP unit, so the cleaning cycles vary. The timing of the opening and closing of the drain valve was, therefore, a compromise. This resulted in significant quantities of detergent being discharged as waste water.

Conductivity measurements were introduced to control the addition of acid or caustic cleaning solutions and to determine whether the cleaning solution(s) and/or water could be recovered. This indicated when detergent and/or water could be recovered, and whether the right amount of detergent was being used. All existing CIP units were retrofitted with conductivity probes and they were included in the specification for all new units.

The system works by placing a conductivity probe in the main pipeline from the process equipment, close to the detergent tank inlet. The probe monitors the detergent/water concentration flowing through the line during a cleaning cycle. Detergent cleaning is initiated by a timer and detergent gradually replaces the flush water in the system, which is drained for waste water treatment. Once a set detergent concentration is detected, the conductivity probe signals an actuator to close the drain valve. The flow is then diverted back to the detergent tank and circulated through the system, rather than being discharged. The rinse stage is then initiated by a timer; detergent is recycled back to the detergent tank until dilution has occurred and the set detergent concentration is reached again. At this point, a signal from the conductivity probe opens the drain valve and the rinse-water is drained for waste water treatment until the probe detects clean water again.

The drain valve is then closed and the clean water is diverted to the water tank. The conductivity probe also ensures that the required detergent strength is maintained throughout the cleaning process. Minimal operator attention is required. Each conductivity probe receives some cleaning when the process equipment is cleaned in place. Daily detergent use is monitored by a flow-meter on every CIP unit. If detergent use increases, this indicates that the probe requires further cleaning, i.e. a 10 minute task done by the operators. Additional probe cleaning is usually required every 4 to 6 weeks.

The dairy reports an estimated 15 % saving on detergent for each CIP unit; reduced amounts of water and detergent discharged for waste water treatment; reduced downtime of equipment and optimised quantity of detergent used for each cleaning cycle.

In another dairy (Example B), conductivity meters were installed to help reduce detergent use. The conductivity probe detects whether water or detergent is in the line and, if detergent is present, it diverts the flow to a detergent recovery tank. The result was recycling of rinse-water, reduced use of detergent and a consequent reduction in COD in the waste water.

Applicability

Widely applicable in the FDM sector in processing and cleaning applications. Examples of the use of conductivity measurement in the FDM sector are shown in Table 4.16. Typical applications of conductivity measurement in the FDM sector are shown in Table 4.17.

Activity	Reason for control
Monitor levels of dissolved salts prior to water re-use	Minimise fresh water use and waste water generation
Monitor well water	Minimise production of poor quality product (that becomes waste) due to use of unsuitable process water

Table 4.16: Examples of the use of conductivity measurement in the FDM sector

Sector/activity	Application
CIP	Conductivity monitoring for plant valve control, based on differences between product, e.g. between beer and water or caustic and acid
Bottling (general)	Conductivity monitoring of caustic use in bottle-cleaning solutions
Product monitoring (inductive sensors)	Throughout the drinks industries and in dairies

Table 4.17: Typical applications of conductivity measurement in the FDM sector

Economics

The saving on detergent by the Example A dairy, is reported as GBP 13000/yr. The company report a payback period of 16 months.

The Example B dairy reported savings of GBP 10000/yr and a payback period of 4 months on the investment.

Driving force for implementation

Reduced detergent use.

Example plants

Numerous installations in the drinks and dairy industries and where CIP is used.

Reference literature

[11, Environment Agency of England and Wales, 2000, 18, Envirowise (UK) & Entec UK Ltd, 1999]

4.1.8.5.3 Turbidity measurement

Description

Scattered light turbidity devices use a light diffusion method to measure the light scattered through a right angle by the particles or bubbles in the liquid. This method is used for low to average turbidity measurements, including the measurement of turbidity in distilled water. Sampling devices can be used when it is difficult to install the turbidity meter into a process line. This helps to improve hygiene.

Suspended solids turbidity meters work using a light absorption method that measures the amount of light transmitted through matter in the process fluid. They are used for measuring medium to high levels of turbidity.

Achieved environmental benefits

Reduced material loss during processing, increased re-use of water and reduced waste water generation.

Operational data

Turbidity meters should preferably be installed in vertical pipes with an upward flow and the optical unit facing the direction of flow for maximum self-cleaning. To avoid incorrect measurements from floating or settled debris, horizontal pipes should have meters installed at the side and not at the bottom or top, to avoid fouling by deposition and floating debris respectively. The fluid velocity should not exceed 2 m/s to avoid spurious readings. To minimise deflection of the beam, gas bubbles and degassing should be avoided.

In a reported food manufacturing process, some product was lost to drain during the separation stages, which resulted in a breach of the company's water discharge consent. The installation of a hygienic turbidity meter and a flow-meter resulted in reduced product losses to drain, increased product yield and financial savings.

In the same example dairy reported as Example A in Section 4.1.8.5.2, whey, a by-product of cheesemaking, is concentrated using an evaporation stage prior to spray drying to make whey powder. The evaporators are regularly cleaned in place, which involves flushing out residual concentrated whey prior to detergent cleaning, i.e. pre-rinsing. A significant quantity of whey was being lost to drain when the evaporator was taken off-line for CIP.

A turbidity probe was installed at the end of the fill line to the concentrate tank as part of an automatic recovery system. The probe detects the presence of water/whey mixtures and sends this information back to the control system. Recovery of concentrated whey to the whey storage tank is then controlled via a densimeter, while the turbidity probe controls the recovery of the water/whey mixture to a separate tank. The mixture is subsequently mixed with raw whey for reprocessing. When the turbidity is between certain set points indicating the presence of whey, the flow is automatically diverted to the recovery tank via actuated valves. When the detergent cycle starts, the probe signal is overruled to ensure no acid or alkaline detergent is diverted into the whey tank. Contamination of the recovered whey is avoided and only clear or water containing detergent is discharged for waste water treatment. The whey recovery process is shown in Figure 4.9.

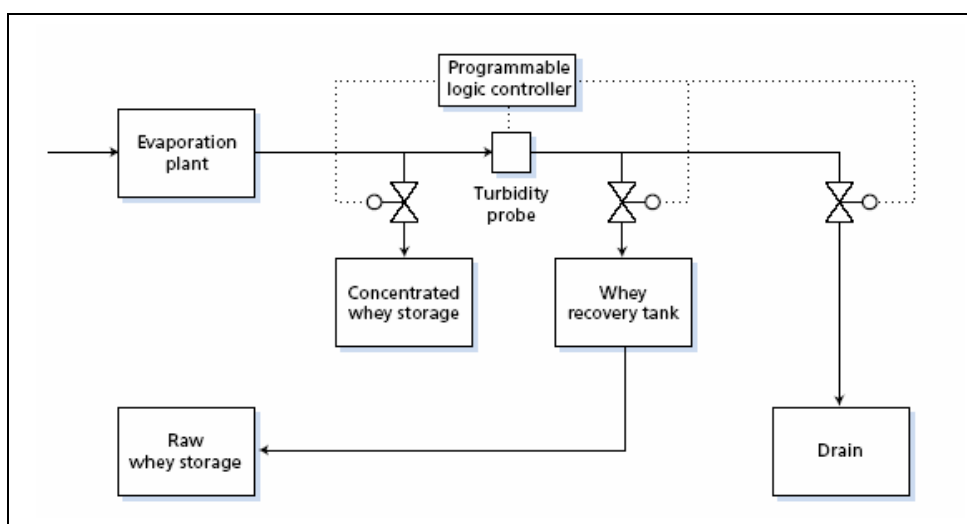

Figure 4.9: Whey recovery using turbidity measurement

It is reported that no problems have occurred since the whey recovery system began operating in 1996. When the system was first installed, training was provided for operators to make them aware of how the new system operated and its benefits. Operating costs are reported to be negligible and the turbidity probe requires little maintenance. The probe is cleaned in place when the main evaporator is cleaned. Planned maintenance is performed annually. The benefits reported include cost savings, increased product yield, less whey lost to drain and lower WWTP costs.

Applicability

Applicable where product yield can be increased by recovery from process water and for the re-use of cleaning water.

Examples of the use of turbidity measurement in the FDM sector are shown in Table 4.18.

Activity	Reason for control
Monitor quality of process water	Minimise waste water from out-of-specification process water or products
Monitor CIP systems	Optimise re-use of cleaning water, thus minimising waste water generation

Table 4.18: Examples of the use of turbidity measurement in the FDM sector

A typical application of turbidity measurement in the FDM sector is the monitoring of process waste streams to determine viability for recovery back into the process.

Economics

The food manufacturing company referred to reported lower waste water treatment costs and savings of over GBP 100000/yr.

Example dairy A reported cost savings of around GBP 16000/yr and a payback period of 8 months on combined capital and installation costs.

Driving force for implementation

Reduced product loss.

Example plants

At least one cheesemaking dairy and another unspecified food manufacturing installation in the UK.

Reference literature

[11, Environment Agency of England and Wales, 2000, 18, Envirowise (UK) & Entec UK Ltd, 1999]

4.1.8.6 Use automated water start/stop controls

Description

Sensors such as photocells can be fitted to detect the presence of materials and to supply water only when it is required. Water supplies can be turned off automatically between products and during all production stoppages.

Achieved environmental benefits

Reduced water consumption, reduced volumes of water requiring treatment and if the pressure is regulated, reduced entrainment of biological matter and contamination.

Operational data

Care taken during the selection, installation and maintenance of the photocells can make certain that they are reliable and their correct position ensures that products are washed to the extent required and no more.

Use of the technique pre-supposes that water needs to be applied to each product detected and the technique does not distinguish between clean and dirty products.

Applicability

Applicable where a water supply is required intermittently.

Driving force for implementation

Reduced water costs.

Reference literature

[1, CIAA, 2002]

4.1.8.7 Use of control devices

Description

Valves are the most common control device and they are extensively used with both manual and automatic control systems. Valves are often used to modify a flowrate to control a different process parameter, e.g. the temperature of chocolate can be measured and, if necessary, adjusted by controlling the flowrates of heating and cooling water. Examples include flow regulators and solenoid valves; others are available.

Flow regulators are used to provide a constant flow at a predetermined rate. The flow through the regulator can be adjusted within a limited range, but these devices are designed with the intention that adjustments are infrequent.

Solenoid valves are two position devices where a solenoid is used to open or close a valve on receipt of a control signal.

Achieved environmental benefits

Reduced water consumption and associated energy use.

Operational data

An example food manufacturing company identified that excessive water consumption by its vacuum pumps was due to a higher flow than necessary for the seal water. Although the maximum flow for the service liquid should have been 2.7 m³/h, the actual flow was almost 11.5 m³/h, i.e. over four times the design requirement. Installing constant flow valves to ensure the correct flowrate to each of the water ring vacuum pumps reduced water use by approximately 60000 m³/year, corresponding to 7.5 % of the site's mains water consumption. Water and waste water costs fell and there was reduced energy consumption and wear of the vacuum pumps.

At an example chicken processing company, excessive water consumption was identified. Flow regulators were installed to fix the water supply to particular processes at the rate required by the process, thereby saving on water consumption.

An example fish processing company installed a solenoid system on the water supply to a pre-wash system. Water had previously flowed continuously, causing overflowing and entrainment of debris into the waste water. The solenoid enabled the water supply to be shut off when the conveyor belt was not in use. Water used by the process fell by 40 %.

Applicability

Flow regulators are widely applicable, where a constant flow is required at a set rate.

The use of solenoid valves is applicable throughout the FDM sector and they are frequently used to control water supply.

Economics

The introduction of constant flow valves in the food manufacturing installation referred to resulted in costs falling by GBP 70000/yr, giving a payback on the investment of less than one month.

At the chicken processing installation, the introduction of flow regulators cost less than GBP 1000 and resulted in water savings worth over GBP 10000/yr.

At the fish processing installation, the 40 % reduction in water use saved GBP 2500/yr and gave a payback period of 5 weeks.

Driving force for implementation

Reduced water consumption and associated costs.

Example plants

Widely applied in the FDM sector.

Reference literature

[11, Environment Agency of England and Wales, 2000, 18, Envirowise (UK) & Entec UK Ltd, 1999]

4.1.8.8 Use of water nozzlesDescription

Water nozzles are widely used in the FDM sector, e.g. for washing and sometimes for thawing the product, and cleaning the equipment during processing (see Section 4.3.7.1). Water consumption and waste water pollution minimisation can be carried out by correctly positioning and directing the nozzles. The use of presence-activated sensors and most importantly, only installing them where required, can ensure that water is only consumed where necessary. Removing nozzles where water is used to direct food and replacing them with mechanical devices can reduce water consumption, and the entrainment of food particles in water which would then have to be treated in a WWTP.

In addition, water consumption can be optimised by monitoring and maintaining the water pressure of the water nozzles. Water pressure can be adjusted according to the unit operation requiring the highest pressure, and a suitable pressure regulator can be installed at each of the other unit operations which require water.

Achieved environmental benefits

Reduced water consumption and waste water generation. Reduced waste water pollution, e.g. due to the reduction of the contact time between the food and water.

Operational data

When processing Vienna sausages, cooling is required after smoking. This is normally carried out by showering the sausages in the smoking cabinet or in a specially designated area. A large quantity of water is often used for this purpose if irrigation pipes are used. Water consumption is commonly around 3.5 m³/t. Instead of irrigation pipes, water saving nozzles and a timer control are reportedly used. To avoid unnecessary waste, the nozzles have to be correctly positioned and directed so that all the water hits the sausages. When cooling is carried out in cabinets specially designed for the purpose, the sausages can be sprayed with finely atomised water, the water supply is then stopped and air is pulled through the cabinet. This causes the water on the surface of the sausages to evaporate. As the surface dries out, a new cycle of water spraying and drying is started. The method results in substantial water savings.

Nozzles are also used when sausages are vacuum packed. A vacuum packing machine uses cooling water, approximately 0.2 m³/t of sausages. Setting the water quantity and fixing and locking the position of the nozzles minimises water consumption. Another possible alternative is to collect and re-use the cooling water.

In the fish sector, a reduction in water consumption of about 0.13 to 0.2 m³/t raw material has been reported.

In white fish filleting, water consumption can be reduced by up to 90 % by installing nozzles and sprinkling the water in one or two seconds out of every three. In the sorting of herring and mackerel, a 50 – 65 % reduction in water consumption can be achieved by regulating the nozzle sizes so that they only supply the necessary amount of water.

It is reported that in fish skinning and cutting, reducing both the number and size of spray nozzles can lead to water savings of about 75 %. In fish filleting, a reported reduction of 60 to 75 % in water consumption is obtained by using the following means which combine a planned use of nozzles and other techniques:

- removing unnecessary water nozzles
- using water nozzles instead of water pipes for washing the product
- using mechanical devices instead of water nozzles to move the fish from the tail cut
- replacing the nozzles for washing the driving wheels on the filleting part with mechanical scrapers
- replacing existing nozzles by nozzles with a lower water consumption
- using pulsating water nozzles, i.e. alternating the opening and closing of the water supply with an automatic valve
- replacing the waste drain by mesh conveyors and closing the nozzles in the waste drain. The waste will be separated from the process water directly near the filleting machine, resulting in shorter contact time and less entrainment of, e.g. fat (see Section 4.7.2.6)
- using presence-activated sensors to control when the nozzles operate
- using dry transport of viscera and fat (see Section 4.7.2.6)
- removing skin and fat from the skinner drum by vacuum (see Section 4.7.2.4).

The frame can be cut from fish fillets by two sets of rotating knives. The knives may need to be cooled with water from nozzles, which can also clean off fish meat and scale, although it may be possible to do this mechanically.

Applicability

Applicable to all the FDM sectors. In the fish sector, nozzles are used in scaling, skinning, cutting, eviscerating, and filleting. In the meat sector, they are used in the processing of sausages. In brewing, they are used for cask and bottle cleaning.

Example plants

Used in the Danish herring industry (see Section 4.7.2.9.1).

Reference literature

[28, Nordic Council of Ministers, 1997, 41, Nordic Council of Ministers, 2001, 134, AWARENET, 2002]

4.1.9 Selection of materials

4.1.9.1 Selection of raw FDM materials which minimise solid waste and harmful emissions to air and water

Description

A proportion of virtually all of the raw and auxiliary materials used will end up as solid waste or in an installation's WWTP. Auxiliary materials are those materials used in processing raw materials that do not end up in the final product, e.g. cleaning materials. The majority of raw materials used in the FDM sector are natural and they usually have a high organic matter content and their effect on the local terrestrial and aquatic environment can be considerable.

In practice, the option of using different raw materials is often limited as the materials are specified in recipes and there are often few or no alternatives. Some sectors try to use raw materials which result in fewer by-products or wastes.

The selection of fresh materials and those which meet the quality standards required for processing at the installation, before the materials are received at the installation, can minimise the amount of waste due to disposal of, e.g. over-ripe fruit and vegetables or fish that has started to decompose and is unsuitable for processing. This can be helped if agreements are made with the grower/supplier about, e.g. time of harvesting, harvest production and harvest processing. Additionally, agreements can be made about the use of pesticides, e.g. about ceasing their use sufficiently in advance of harvesting to minimise the contamination of waste water from washing fruit and vegetables.

Achieved environmental benefits

Reduced wastage of raw materials, waste water contamination and odour emissions.

Operational data

The specification for raw materials can be agreed with the supplier and off-specification raw materials can be returned to the source, if they are delivered to the FDM installation. This can maximise the proportion of the raw material which ends up in the product and consequently minimise the amount which ends up as waste or as a lower value by-product, such as animal feed.

This can be achieved by the supplier exercising quality control as well as the operator carrying out quality checks at the FDM processing installations. For example, this is routinely undertaken at dairies. The milk arrives in road tankers and staff at the dairy visually inspect the milk, smell it and carry out laboratory tests. If the milk does not meet the standard required, it is not accepted on the site.

Applicability

Applicable to all FDM installations.

Driving force for implementation

Maximising product yield and minimising waste disposal costs.

Reference literature

[31, VITO, et al., 2001]

4.1.9.2 Selection of auxiliary materials used

Chemicals are also used in food manufacturing processes (e.g. in caustic peeling, vegetable oil hardening, coagulation, alkalising, neutralisation). For some of the substances used in food manufacturing processes there is an EU-wide risk assessment compiled under the Existing Substances Regulation (793/93/EEC) available. These risk assessments cover risks to the environment and human health. For substances not assessed under 793/93/EEC, information on hazards and risks have to be gathered from other sources to ensure that the risk is minimised and less hazardous alternatives are chosen where practicable [199, Finland, 2003]. An example is the risk assessment and management strategy developed for Germany [154, Ahlers J. et al., 2002].

Substitutes can be used for carcinogenic, mutagenic or teratogenic input materials.

4.1.9.3 Avoiding the use of ozone depleting substances, such as halogenated refrigerants

Description

Refrigerants are widely used in the FDM sector in cooling, refrigeration and freezing operations. The interaction of halogen refrigerants with ozone in the air has resulted in the progressive prohibition of the placing on the market and use of ozone depleting substances and of products and equipment containing those substances [202, EC, 2000]. There is currently a proposal for a Regulation of the European Parliament and of the Council on certain fluorinated greenhouse gases [246, EC, 2003].

These compounds have been substituted by other refrigerants such as ammonia and glycol or, in some cases, by chilled water.

Achieved environmental benefits

Reduced risk of ozone depletion and global warming.

Cross-media effects

The risk of ammonia and glycol leaks, which can cause health and safety problems.

Operational data

The use of substances that deplete the ozone layer can be prevented or minimised by [65, Germany, 2002]:

- using substitutes for such substances
- when ozone depleting substances are used, using closed-circuit systems
- enclosing systems in buildings
- encapsulating parts of systems
- creating a partial vacuum in the encapsulated space and preventing leaks in systems
- collecting the substances during waste treatment
- using optimised waste gas purification techniques
- proper management of the recovered substances and the waste.

Driving force for implementation

Legislation.

4.2 Techniques applicable in a number of FDM sectors (reflects the structure of Chapters 2 and 3)

4.2.1 Materials reception, handling and storage

4.2.1.1 Switch off the engine and refrigerator unit of a vehicle during loading/unloading and when parked

Description

The running engines and the refrigeration units of vehicles can cause noise nuisance. This can be avoided by switching them off during loading, unloading and when the vehicle is parked. If it is necessary to maintain chilled or frozen storage conditions in a vehicle this can be done by using the power supply from the installation.

Achieved environmental benefits

Reduced noise emissions.

Applicability

Applicable during loading and unloading of vehicles whether refrigerated or not.

Driving force for implementation

Reduced noise emissions.

Reference literature

[31, VITO, et al., 2001]

4.2.2 Thawing

4.2.2.1 Thawing using recirculation and air stirring

Description

The water used for thawing is recirculated in a closed-circuit and used again. Air is used to stir the water during thawing. Level-actuated switches can be installed to control the amount of water fed into the tank. For shrimps and prawns, filtered peeling water can be used.

Achieved environmental benefits

Reduced water consumption. Reduced waste water volume and pollution.

Cross-media effects

Energy consumption.

Operational data

In the fish sector, a water consumption decrease from 5 to 2 m³/t of raw fish is reported, compared to running water.

Applicability

Applicable in the meat sector and in the fish sector for mackerel, shrimps and prawns.

Reference literature

[134, AWARENET, 2002, 182, Germany, 2003]

4.2.2.2 Thawing in containers filled with warm water with air bubbles at the bottom

Description

Thawing is carried out in containers filled with water at 30 – 35 °C, while air is bubbled in at the bottom. Level-actuated switches can be installed to control the amount of water fed into the tank. The water flow also affects the temperature. For shrimps and prawns, filtered peeling water can be used.

Achieved environmental benefits

Reduced water consumption. Reduced waste water volume and pollution.

Cross-media effects

Energy consumption.

Operational data

A reduction in water of up to 60 % compared to thawing in running water was achieved in a fish processing installation in Denmark. Water consumption decreased from 5 m³/t of raw fish down to 1.8 – 2.2 m³/t.

Applicability

Applicable in the meat sector and in the fish sector for whitefish, shrimps and prawns.

Economics

In the Danish example, the cost of the equipment with a capacity of 18 t/d of raw fish, which is equivalent to 3600 t/yr of raw fish, was estimated at about DKK 300000. The cost saving in water consumption was DKK 10800.

Driving force for implementation

Cost saving in water consumption.

Example plants

Used in at least one fish processing installation in Denmark.

Reference literature

[28, Nordic Council of Ministers, 1997, 134, AWARENET, 2002]

4.2.2.3 Thawing by sprinkling

Description

Thawing is achieved by sprinkling the food with water.

Achieved environmental benefits

Reduced water consumption. Reduced waste water volume and pollution.

Cross-media effects

The food surface may dry and its unsaturated fats, e.g. in pork, may oxidise.

Operational data

Compared with thawing by immersion into running water, this technique consumes less water but requires longer times and larger surface areas.

Applicability

Applicable in the meat and fish sectors.

Reference literature

[134, AWARENET, 2002]

4.2.2.4 Thawing by 100 % water saturated heated air

Description

Thawing is achieved by exposing the food to 100 % water saturated hot or warm air.

Achieved environmental benefits

Reduced water consumption. Reduced waste water volume and pollution.

Cross-media effects

Energy is consumed to produce the air bubbles.

Operational data

Compared with thawing by immersion into running water, this technique consumes less water but requires longer times and larger surface areas.

Using hot air may cause a rapid growth of micro-organisms on the surface layers of the thawed product and hinder reabsorption of thawed water. This creates unsightly and often nutritionally wasteful drip loss. Furthermore, the food surface may dry and its unsaturated fats, e.g. in pork, may oxidise. Energy consumption is higher compared to other thawing techniques, as hot air is used.

When warm humid air is used to thaw blocks of frozen white fish, it can cause problems in maintaining the quality of the finished product because the fish at the edge of the frozen block thaw before the fish in the middle of the block.

Dry thawing is reported to adversely affect the quality of shrimps and prawns.

Applicability

Applicable in the meat and fish sectors.

Example plants

Commonly used in white fish processing in the Nordic countries.

Reference literature

[28, Nordic Council of Ministers, 1997, 134, AWARENET, 2002]

4.2.2.5 Thawing in air

Description

Thawing is carried out in a coldroom at a controlled temperature for 18 – 24 hours.

Achieved environmental benefits

Reduced water consumption and waste water production.

Cross-media effects

Energy is consumed to maintain the coldroom at a controlled temperature.

Operational data

It is reported that when meat is thawed in containers filled with water, the meat juice is extracted and the proteins degraded. Thawing meat in a climate chamber at 0 °C is reported to be better for the meat quality, but require longer times and larger surface areas. The meat surface may become dry and unsaturated pork fats may be oxidised. Losses can occur due to the dripping of meat juice.

Applicability

Applicable in meat processing.

Reference literature

[254, Denmark, 2005]

4.2.3 Centrifugation/separation**4.2.3.1 Minimisation of centrifugal separator waste discharges**Description

Both the frequency and the volume of waste discharges from centrifuges are usually specified by the manufacturers of the equipment. Where this information is known, the actual performance can be checked against the specification. By running the equipment at its specified performance, it may be possible to reduce the amount of the phase discharged as waste and increase that retained as product, whilst maintaining quality and hygiene standards. This may be achieved by maintaining close co-operation with quality assurance personnel.

Achieved environmental benefits

Reduced wastage of raw materials.

Operational data

It is reported that in dairies, 1 % of raw milk supplied is wasted and that 0.1 % of this is during the processing of the milk and most of that is lost via discharges during centrifugal separation.

Applicability

Applicable for all centrifugal separators.

Driving force for implementation

Reduced loss of raw materials and increased yield.

Reference literature

[11, Environment Agency of England and Wales, 2000]

4.2.4 Fermentation**4.2.4.1 Carbon dioxide recovery and purification**Description

The CO₂ generated during the fermentation process can be collected, cleaned, compressed, dried, purified and liquefied. It can then be used.

CO₂ released during fermentation is passed to a recovery unit. The CO₂ to be recovered contains all the volatile components present or produced during fermentation including oxygen, fusel oils and carbonyl and sulphur compounds with very low flavour thresholds, e.g. hydrogen sulphide. For this reason, the CO₂ has to be purified to the degree necessary for its intended use.

The purification process or conditioning includes a foam separator, gas scrubbing with water to reduce the sulphur compounds, drying, flavour removal with activated charcoal, oxygen removal and compressing to liquid for its storage. It can then be drawn off as needed from the storage tank, re-vaporised and used in production.

Achieved environmental benefits

Reduced CO₂ emissions at installation level. Reduced consumption of fossil fuels and energy for the production of CO₂ especially for use in the installation.

Cross-media effects

Energy consumption.

Operational data

In the brewing sector, the reduction in CO₂ emissions with this system is around 2 kg/hl (20 kg/m³) of beer produced.

Untreated CO₂ with an impurity of 20 – 1000 ppm can be recovered from the fermentation process. The oxygen level in the liquefied CO₂ can be reduced from an initial value of 40 to 1000 ppm to an output purity of 5 ppm. This is achieved by the “oxygen reduction system”. Figure 4.10 shows the process sequence in the CO₂ conditioning system.

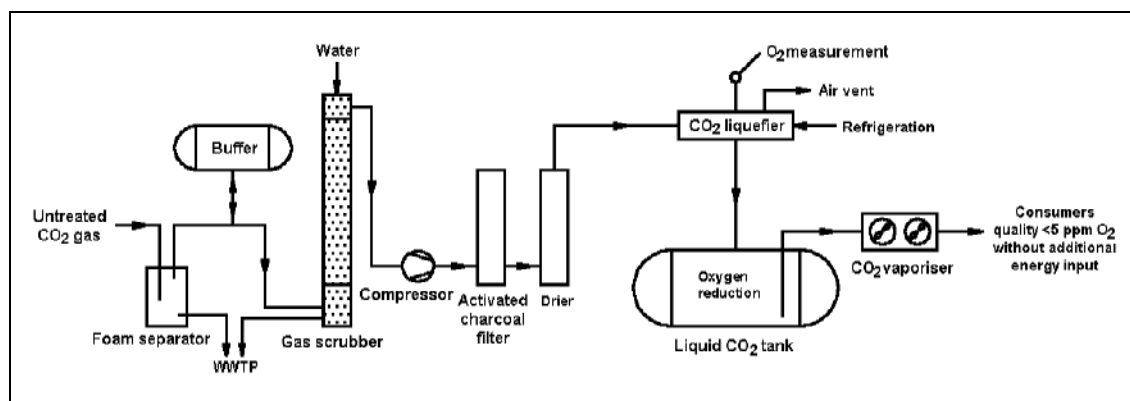

Figure 4.10: Process flow diagram of a CO₂ conditioning system in a large brewery

If closed-circuit cooling water is used for cooling the air compressors and the CO₂ compressor, this prevents water losses and minimises waste water volumes.

The decision whether to buy CO₂ produced as a co-product by another sector may be based on the quality available.

Applicability

Applicable in breweries, wineries, distilleries and for cider production. The opportunities for using the recovered CO₂ vary between sectors, and are as follows:

- neutralising waste water, with minimum purification – all fermenting sectors
- carbonating drinks – brewing, sparkling wine, cider, soft drinks and mineral water
- as a carrier for drinks dispensing, e.g. beer, cider and carbonated soft drinks
- for counter pressure in filtration units; tanks and bottles, e.g. beer, cider and carbonated soft drinks.

Economics

Industrial gas companies can supply CO₂, which is usually a co-product from other sectors, at a cheaper price than the production cost price in the installation.

Driving force for implementation

Avoiding CO₂ emissions and avoiding the need to purchase CO₂ from third parties. The use of own-site recovered CO₂ avoids the risk of contamination, taste and odour problems from off-site sources.

Example plants

Used in the brewing sector.

Reference literature

[65, Germany, 2002, 159, CIAA-CEFS, 2003, 182, Germany, 2003, 199, Finland, 2003]

4.2.5 Smoking

Smoking is the process of cooking, preserving or flavouring food by exposing it to smoke. There are two types of smoking. Hot smoking is typically carried out at 65 – 120 °C and can be used to fully cook foods. Hot smoking uses smoke generated from burning and smouldering wood. Cold smoking is typically carried out at 30 – 55 °C and is generally used to preserve or flavour foods. Cold smoking uses smoke generated from smouldering wood, smoke condensates (liquid smoking), friction and superheated steam. The different methods used for smoke generation are described in Sections 4.2.5.1 to 4.2.5.5.

The VOC content in the smoke depends, to a large extent, on the method of smoke generation. The method influences emissions and thus the need for air cleaning. The type of smoke chosen determines the flavour achieved.

The exhaust from the smoking kilns is treated using incineration. Energy consumption can be reduced using catalytic incineration and heat recuperation.

Tar is deposited on smoking sticks and in the smoking chamber. The sticks are cleaned in a constantly moving drum, which ensures that the sticks rub hard on each other to remove the deposits. The tar is then removed by a controlled water supply and not running water. Tar deposited in kilns or troughs is collected and handled as chemical waste and not via the WWTP.

Smoking frames are often cleaned manually with a pressure cleaner. A washing cabinet which collects and recirculates water containing detergents, is used. The drain may automatically be changed over to the WWTP at the final rinse. As an alternative, a washing tunnel could be used with water from the second stage re-used for the initial rinse.

Table 4.19 shows the environmental impact of the different methods for smoke generation.

	Air emissions	Air treatment	Tar deposits	Cleaning (water consumption/waste water pollution)
Burning wood	Large content of VOCs	Needed	Large content	Water consumed and waste water produced due to cleaning
Smouldering wood	Up to 200 chemical components	Needed	Large content	Water consumed and waste water produced due to cleaning
Liquid	Reduced to a large extent, e.g. odour/VOCs	Reduced considerably	No deposits	Reduced
Friction	Reduced	Unnecessary	Reduced	Reduced, powerful detergents are not needed
Superheated steam	Reduced	Reduced	Reduced	Reduced

Table 4.19: Environmental impact of the different methods for smoke generation

4.2.5.1 Smoke from burning woodDescription

The equipment for generating smoke from burning wood consists of a chamber with a smoke generator. In the simplest operation, the products are hung on racks in the chamber with a fire of wood dust or chips ignited on the floor. This fire is suitably dampened to maximise the smoke production and to avoid flame production. The product increases in temperature to about 30 °C. The smoking period may last for up to 48 hours.

Cross-media effects

Exhaust air with a large VOC content. Large quantities of tar are deposited in the smoking chamber.

Operational data

It is reported that burning sawdust produces smoke with a large content of VOCs. An open or semi-open system is used and a supply of air is necessary, i.e. a surplus of air is used which will require cleaning before it is released to the air.

When wood chips are used in the smoke generator, the air supply, and thus also the temperature, are both normally higher. More tar compounds are formed and the need for cleaning is, therefore, greater. Smoke cleaning is also normally required in this case.

In a Norwegian investigation, the control programme for the smoking process was altered to take account of the need for smoke. The smoke generator was thus closed down before the smoking process was completed. This reduced the consumption of wood chips from 8.9 to 3.6 kg per tonne of sausages without changing the product quality.

Applicability

Applicable in the processing of fish and meat.

Reference literature

[41, Nordic Council of Ministers, 2001]

4.2.5.2 Smoke from smouldering wood

Description

Smoke from smouldering wood consists of two phases, i.e. a disperse liquid phase, e.g. droplets, and a vapour phase. The former contains particles of smoke, which are not regarded as important in the smoking process. The vapour phase is more important in imparting flavour.

Smoking can take place at two temperature levels, i.e. ambient, up to 30 °C, and at elevated temperatures, between 50 and 90 °C. The heat from the smouldering wood is not enough to raise the temperature up to between 50 and 90 °C, so extra heat is added by means of steam or a heat-exchanger. The duration of the smoking depends on the product. Some products require pre-drying or drying or maturing between smoking steps. Conditioned air, which is temperature and moisture heated by steam-pipes or electrical heaters, is used to control the drying of the product. The time the product is in the chamber varies from hours to days. The period the product is smoked can range between 15 minutes to 4 hours per phase.

Cross-media effects

The vapour phase contains up to 200 chemical components, not all of which have been identified. They include a range of organic acids, aldehydes, ketones, alcohols and polycyclic hydrocarbons. Tar is deposited in the smoking chamber.

Operational data

It is reported that the smoke generator can be a small oven where hardwood chips or sawdust are slowly added onto a bed of already smouldering wood or onto an electrically heated grid. Air is blown through the small oven and carries the smoke into the smoking chamber where the product is located. The smoke exiting the chamber is vented to the air or partially recirculated. In more sophisticated systems, the equipment may also include an air conditioning unit to, e.g. ventilate, cool, heat or moisturise the air. In older types of cold smoking kilns, the sawdust is often burned directly on the floor.

Applicability

Applicable in the processing of fish and seafood, meat, cheese, and fruit and vegetables.

Reference literature

[41, Nordic Council of Ministers, 2001]

4.2.5.3 Liquid smoke

Description

Liquid smoke is produced by condensation of the smoke, followed by fractional distillation to reduce the content of tarry matter and other contaminants. The resulting solution is diluted with water and sprayed onto the product. In some cases, it is incorporated into a curing brine and injected into the product for flavouring purposes.

The advantage is that the smoke flavour can be achieved without smoking and, therefore, the components in the smoke, which are suspected to be damaging to health, are, to a large extent, avoided. As there is no emission of smoke, the need for air treatment is considerably reduced.

Achieved environmental benefits

Reduced air emissions, e.g. odour/VOCs. Tar is not produced during this method of smoking.

Operational data

When Vienna sausages are smoked/cooked, emissions of 2 – 3 million odour units per batch have been measured in Denmark from a kiln using a scrubber, and in the order of 100000 odour units from a kiln where liquid smoke was used (unpublished results, DMRI). It can, therefore, be suggested that odour can be eliminated by using liquid smoke. However, it must be emphasised that liquid smoke results in a smoke flavour which is different from the flavour achieved with conventional smoking; this might not necessarily be acceptable to the customers, on the grounds of taste or smell. It will thus not always be possible to choose liquid smoke for processed meat products.

Applicability

Applicable in the processing of fish and seafood, meat, cheese, and fruit and vegetables.

Example plants

Used in meat processing, e.g. in the production of Vienna sausages.

Reference literature

[41, Nordic Council of Ministers, 2001]

4.2.5.4 Friction smoke

Description

Smoke is generated from the friction between wood and a rapidly rotating rough roller which creates pyrolysis. The smoke is mild and contains hardly any carcinogenic compounds. The process can be carried out in a closed system with recirculation, so that use of an afterburner or other smoke cleaning system is unnecessary. This method claims to enable a more precise control of the volume of smoke produced, by altering the pressure between the wheel or disc and the wood.

Achieved environmental benefits

Reduced energy and water consumption. Reduced waste water pollution. Reduced tar production.

Operational data

It is reported that the energy saving is often 50 % of the energy consumption. As a result of the mild smoke, the deposits in the smoking chamber are less than 10 % of the deposits created with wood chip smoke. Cleaning is, therefore, much easier, and the use of powerful detergents is avoided. There are fewer organic compounds in the waste water, and water is saved due to longer intervals between cleaning.

Applicability

Applicable in the processing of fish and seafood, meat, cheese, and fruit and vegetables.

Example plants

Used in fish processing.

Reference literature

[41, Nordic Council of Ministers, 2001]

4.2.5.5 Smoke from superheated steam

Description

The pyrolysis of wood chips/shavings can also be carried out by passing superheated steam over chips of wood, which transfers the smoke and flavour to the products. This reduces the number of compounds in the smoke and also allows the air surplus to be reduced to a minimum. As the surplus steam can be condensed, the exhaust is therefore low. Cleaning is also easier due to a lower level of tar deposits in the smoking chamber.

Achieved environmental benefits

Reduced air emissions. Reduced tar production.

Applicability

Applicable in the processing of fish and seafood, meat, cheese, and fruit and vegetables.

Reference literature

[41, Nordic Council of Ministers, 2001]

4.2.6 Cooking

Several techniques are available for cooking within the FDM sector; these are described in Sections 4.2.6.1 to 4.2.6.6. These techniques are also used for cooking, e.g. meat and fish, before preservation in cans, bottles and jars (see Section 4.2.8).

4.2.6.1 Water bath oven – cooking water

Description

Water bath ovens allow the best homogeneity of heating to be obtained. Nevertheless, the immersion into hot water causes weight loss and results in proteins and fat being released into the water. This can be skimmed to recover by-products and to avoid it contaminating the waste water. This also increases the potential for cooking water re-use. Cooking water re-use can also be increased by applying membrane systems to clean the water.

Achieved environmental benefits

Reduced water consumption. Reduced waste water pollution. Recovery of by-products from cooking water.

Cross-media effects

When cooking in a water bath oven, a large amount of water and energy are both needed.

Operational data

It has been reported that after the cooking of fish, approximately 3 – 4 g oil/kg fatty fish can be released into the water. By-products, e.g. fatty acids and flavours, are recovered from cooking water.

The use of a water bath oven for cooking meat, prior to canning, produces waste water contaminated with fat, protein and fragments of meat.

Applicability

Widely applicable in the FDM sector, e.g. for meat, fish, shellfish and vegetables.

Reference literature

[89, Italian contribution, 2001, 134, AWARENET, 2002]

4.2.6.2 Water bath oven – using water instead of brine

Description

Cooking in water instead of brine reduces the salinity of waste water.

Achieved environmental benefits

Reduced salinity of waste water.

Operational data

Cooking in brine may be necessary for some recipes.

Applicability

Widely applicable in the FDM sector, e.g. for meat, fish, shellfish and vegetables.

Reference literature

[134, AWARENET, 2002]

4.2.6.3 Shower oven

Description

Shower ovens allow a good uniformity of heating and use less water and energy than water bath ovens. They operate by the simultaneous heating action of water sent through the showers and from the saturated steam which rises from the heated collecting basin, at the bottom of the oven.

Achieved environmental benefits

Reduced water and energy consumption, compared to water bath ovens.

Cross-media effects

Energy consumption, e.g. for steam production.

Applicability

Widely applicable in the FDM sector, e.g. for meat, fish, shellfish and vegetables.

Reference literature

[134, AWARENET, 2002]

4.2.6.4 Steam oven

Description

Steam ovens are similar to shower ovens, but they do not have a water shower. Heating is due to the steam produced in the water heated in the collection basin. Cooking by steam reduces water consumption and waste water generation and pollution.

Achieved environmental benefits

Reduced water consumption. Reduced waste water generation and pollution.

Cross-media effects

Energy consumption, e.g. for steam production.

Operational data

The use of a steam oven for cooking meat and fish, prior to canning, produces waste water contaminated with fat, protein and fragments of food.

Applicability

Widely applicable in the FDM sector, e.g. for meat, fish, shellfish and vegetables.

Reference literature

[89, Italian contribution, 2001, 134, AWARENET, 2002]

4.2.6.5 Hot air oven

Description

Hot air ovens include a recirculation system for hot air, which is obtained by passage through heat-exchangers, and a steam inlet to control food surface humidity. Hot air ovens distribute heat more evenly than other ovens, so cooking time and cooking temperatures can be reduced, thereby cutting energy consumption.

Achieved environmental benefits

Reduced water and energy consumption.

Applicability

Widely applicable in the FDM sector, e.g. for meat, fish and vegetables.

Reference literature

[134, AWARENET, 2002]

4.2.6.6 Microwave oven

Description

In a microwave oven, the food is heated by passing microwaves through it. The resulting generation of heat inside the food facilitates rapid cooking.

Achieved environmental benefits

Reduced water and energy consumption.

Applicability

Widely applicable in the FDM sector, e.g. for meat, fish, shellfish and vegetables.

Reference literature

[134, AWARENET, 2002, 231, Oxford University Press, 2002]

4.2.7 Frying

4.2.7.1 Recirculate and burn exhaust gases

Description

Air emissions are dependent on the operational temperature of frying, e.g. high temperature frying at 180 – 200 °C will result in more rapid production of oil breakdown products than frying at lower temperatures. The air above a fryer is extracted and vented. This exhaust air contains VOCs, and may lead to odour complaints. Oil and heat recovery and recirculation of exhaust gases to the burner minimises these emissions.

Achieved environmental benefits

Reduced air emissions, including odour. Recovery of oil. Recovery of energy. Recycling of exhaust gases.

Operational data

For example, when controlling a crisp frying process, ensuring that the frying process ends when the final moisture content is in the critical range of 1 – 2 % leads to a minimisation of air emissions. Furthermore, to save energy, the heat-exchangers are mounted in the fryer exhaust hood.

Figure 4.11 illustrates a heat and oil recovery system applied to a fryer.

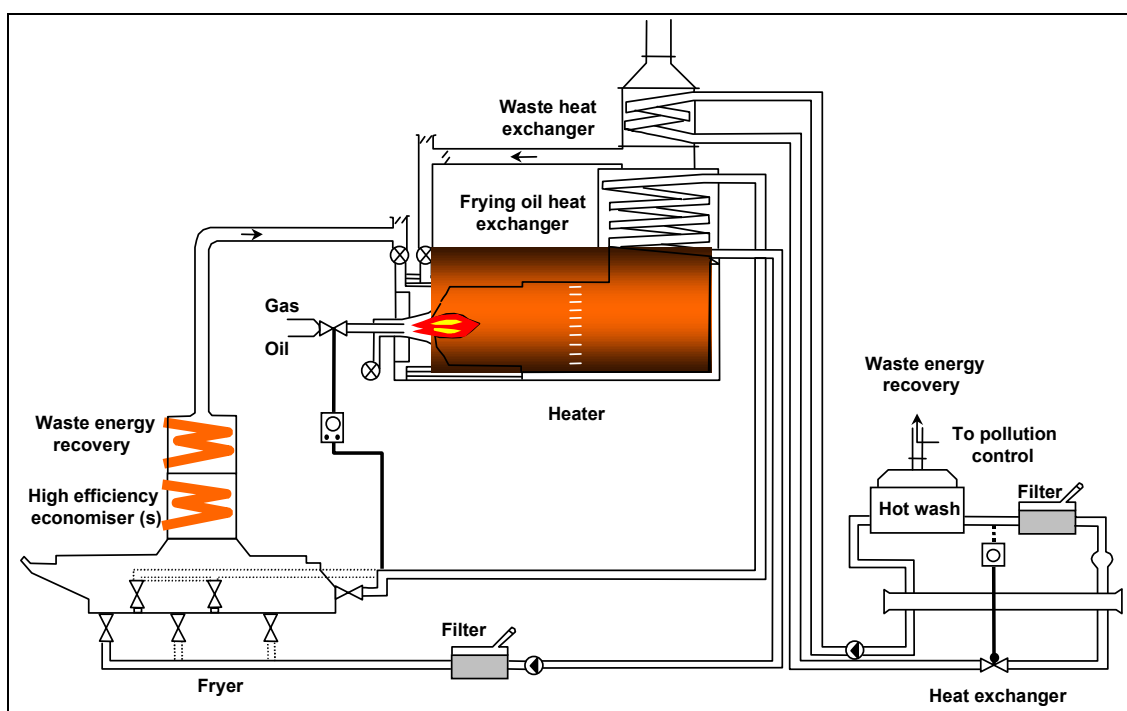

Figure 4.11: Heat and oil recovery: heat-exchangers mounted in the fryer exhaust hood

Applicability

Applicable in the fish, meat and poultry and potato frying sectors.

Reference literature

[85, Environment Agency of England and Wales, 2000]

4.2.8 Preservation in cans, bottles and jars

4.2.8.1 Avoiding cooking before preservation in cans, bottles and jars, if food can be cooked during sterilisation

Description

Before preservation in cans, bottles and jars, the food can be cooked before it is placed into the packaging container. Water bath, shower, steam, hot air and microwave ovens are used for such pre-cooking (see Sections 4.2.6 to 4.2.6.6). Pre-cooking can be avoided if the food can be cooked subsequently, during sterilisation (see Sections 4.2.8.4 and 4.2.8.5).

Achieved environmental benefits

Reduced water and energy consumption. Reduced waste water generation and pollution.

Operational data

In the fish sector, medium-sized and large fish are cooked, e.g. before canning, Small fish such as sardines are canned whole and are then cooked in the cans during sterilisation. The circumstances which enable pre-cooking to be avoided and cooking to take place during the sterilisation step depend on factors such as the size of the food pieces; the size of the cans, bottles or jars; the recipe; ensuring the quality of the product and the length of the sterilisation time.

Applicability

Widely applicable in the FDM sector, for foods that are intended to be preserved cooked.

Reference literature

[134, AWARENET, 2002]

4.2.8.2 Automated filling incorporating recycling of spillages

Description

For foods that are preserved in liquids, automated filling systems for seasonings can be used incorporating closed-circuit recycling of spilled liquids, such as sauce, brine or oil.

Achieved environmental benefits

If hot water can be re-used, there is a reduced consumption of water and energy. Reduced waste water contamination.

Operational data

When canning fish, the cans are filled with brine, sauce or oil. Seasoning liquids can spill giving rise both to a pollution load in the waste water and resulting in an under-use of processing materials if they are not recovered. Contamination of water, e.g. in the steriliser, due to spilled material on the sides of cans reduces the possibilities to re-use that water.

Applicability

Widely applicable, e.g. in preservation of meat, fish, crustaceans, molluscs and vegetables in cans, bottles and jars.

Driving force for implementation

Reduced water consumption and savings in waste water treatment.

Reference literature

[134, AWARENET, 2002]

4.2.8.3 Recovery of floating oil when washing filled cans, bottles and jars

Description

Filled cans, bottles and jars are washed with water and detergents to remove all of the contents that are spilled during filling, such as the sauces, brines or oil. The amount of water used will depend on how the cans, bottles and jars and the food have been handled. Floating oil can be recovered from cleaning tanks. This increases the possibility for recycling the water-detergent solution and reduces the contamination of the waste water.

Achieved environmental benefits

Reduced water consumption and waste water generation.

Applicability

Applicable in the cleaning of cans, bottles and jars filled with vegetable oils, foods which contain fat or oil, or which are canned in oil.

Driving force for implementation

Reduced water consumption and savings in waste water treatment.

Reference literature

[134, AWARENET, 2002]

4.2.8.4 Batch sterilisation after filling of cans, bottles and jars

Description

The filled and sealed cans, bottles and jars are placed in baskets in a steriliser, e.g. a batch wise operated autoclave and heated to a set temperature for a required time to ensure proper sterilisation and preservation of the product. Some foods can also be cooked during this process. After sterilisation, cans, bottles and jars are cooled down to 25 – 35 °C with chlorinated water.

Achieved environmental benefits

Reduced water consumption and waste water generation.

Cross-media effects

The waste water may contain some traces of oil, sauces and brines after sterilisation, if the cans have not been cleaned properly first.

Operational data

To minimise water use, autoclaves with water storage facilities are used. In addition, the water is recirculated for cooling the cans and re-used in cleaning operations when it can no longer be used in sterilisation.

Applicability

Widely applicable in the FDM sector, e.g. in the preservation of meat, fish, crustaceans, molluscs, vegetables, milk, beer and oil.

Reference literature

[134, AWARENET, 2002]

4.2.8.5 Continuous sterilisation after filling of cans, bottles and jars

Description

Continuous sterilisers enable close control over processing conditions and so produce more uniform products. They produce gradual changes in pressure inside the cans, bottles and jars and, therefore, less strain on the seams compared with batch equipment. Continuous sterilisers, e.g. cooker-coolers, can vary slightly in design and size and operate continuously. Some models can accommodate up to 25000 cans, bottles or jars. They carry them on a conveyor through three sections of a tunnel that are maintained at different pressures for preheating, sterilising and cooling. The food can be cooked during preheating and sterilising.

Achieved environmental benefits

Reduced water and energy consumption. Reduced waste water generation.

Cross-media effects

The waste water may contain some traces of oil, sauces and brines after sterilisation, if the cans, bottles or jars have not been cleaned properly first.

Operational data

When using a continuous steriliser, e.g. cooker-cooler, the water is re-used continuously and water is added, as required, to replace the minimal evaporation loss, thereby controlling the amount of water and energy consumed. The water is re-used for cleaning when it can no longer be used in sterilisation.

The main disadvantages of continuous sterilisation include a high in-process stock which would be lost if a breakdown occurred, and in some, problems with metal corrosion and contamination by thermophilic bacteria may occur, if adequate preventive measures are not taken.

Applicability

Widely applicable in the FDM sector, e.g. in the preservation of meat, fish, crustaceans, molluscs, vegetables, milk, beer and oil.

Reference literature

[134, AWARENET, 2002, 232, Fellows P J,]

4.2.9 Evaporation

Drying and evaporation are often the main energy using processes within the FDM sector. In some existing installations, complex combinations of different techniques are applied for various individual unit operations. Evaporation is widely applied to increase the solids content of liquids. Sometimes this is done as a preliminary step before drying, which can be done using a wide variety of techniques. Theoretically, for the evaporation of water 0.611 kWh/kg (2.2 MJ/kg) is required. In practice, this very much depends on the method of evaporation and the type of drier used and it can range from 0.556 – 0.972 kWh/kg (2.0 – 3.5 MJ/kg). The energy consumption for drying can be less if the dry substance content of the wet material is higher. This can be achieved by pre-evaporation or by using special dewatering equipment such as presses or centrifuges. Steam driers can have considerably lower energy consumption if they consist of more stages (see Section 4.7.5.8). Sometimes exhaust gases from combustion CHP equipment (see Section 4.2.13.1.1) are used to dry the products, thereby reducing the energy requirement.

Falling film evaporators can be used for single and multistage evaporation. These are long, tubular structures made from stainless steel. Liquid is introduced at the top of the evaporator and flows as a thin film down the inside surface of heated tubes or plates which are packed into the evaporator. The principle of falling film evaporation is shown in Figure 4.12.

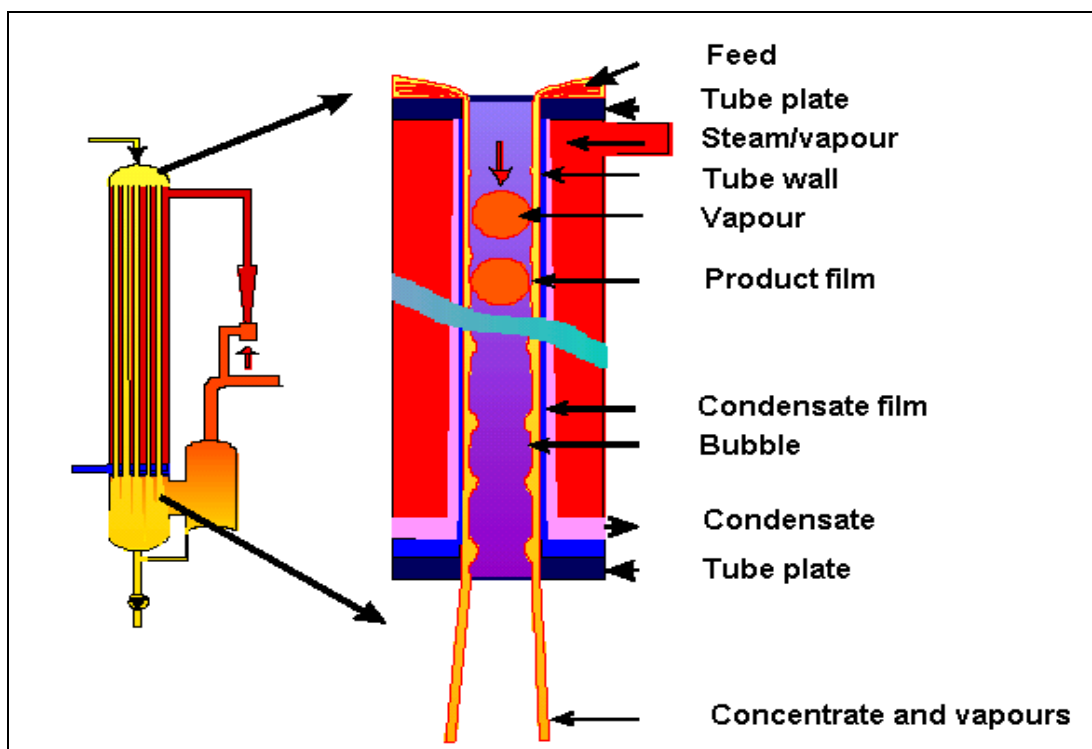

Figure 4.12: The principle of falling film evaporation
[39, Verband der Deutschen Milchwirtschaft (German Dairy Association), 2001]

The outline of an evaporating system is shown in Figure 4.13.

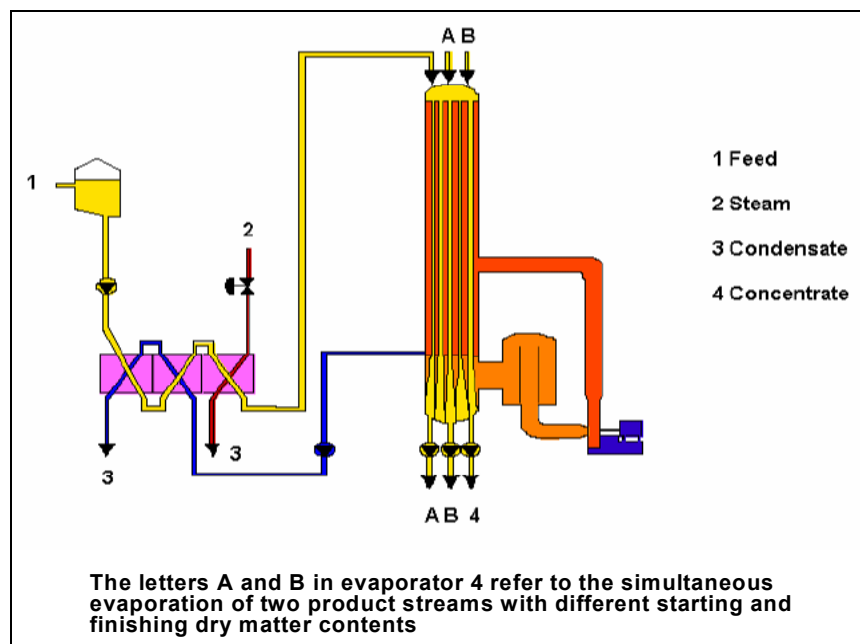

Figure 4.13: Milk evaporation using a falling film

4.2.9.1 Multistage evaporation

Description

Evaporators may operate singly, or evaporation may take place in stages using several evaporators operating in series. Each evaporator is referred to as an effect. With multi-effect evaporator systems, the product output from one effect in the evaporator is the feed for the next effect, and the high temperature vapour that is removed from one effect of the evaporator is used to heat the lower temperature product in the next evaporator effect.

The surfaces within the evaporator are heated by steam, which is injected into the top of the evaporator space. This uses fresh steam or exhaust gases from other operations to boil off water vapour from the liquid in the first stage and is an example of energy recovery/re-use.

The evaporated water still has sufficient energy to be the heat source for the next stage, and so on. Vacuum is applied in a multi-effect chain to enable the water to boil off. The liquid being processed is passed through a series of evaporators so that it is subject to multiple stages of evaporation. In this way, one unit of steam injected in the first evaporator might remove three to six units of water from the liquid. The energy savings increase with the number of evaporation stages. Up to seven stages can be operated in series, but three to five is more common. In the final stage, cooling using cooling water may condense the vapour. Some of the vapours can be drawn off the evaporators to be used as heat sources for other process requirements.

In order to achieve further steam efficiency, the vapour leaving each evaporation stage can be compressed (see Section 4.2.9.2) to increase its energy before it is used as the heating medium for the subsequent evaporator.

Achieved environmental benefits

Reduced energy consumption, e.g. by introducing evaporated vapours to the next stage of the evaporator in which the temperature is lower than the previous one.

Operational data

As the heat is used for the next evaporation stage, multistage evaporators save energy. In contrast, single-stage evaporation does not enable the heat to be recovered.

Steam requirements for single-stage evaporators are 1.2 to 1.4 t/t of evaporated water. Table 4.20 shows a comparison of energy consumption data for different numbers of evaporators using TVR (see Section 4.2.9.2.2). Further energy savings can be made using MVR (see Section 4.2.9.2.1), as can also be seen in the table.

Type of evaporator	Total energy consumption (kWh/kg water evaporated)
TVR 3 stages	0.140
TVR 4 stages	0.110
TVR 5 stages	0.084
TVR 6 stages	0.073
TVR 7 stages	0.060
MVR single-stage	0.015

Table 4.20: Comparison of efficiencies of multi-effect evaporators in the dairy industry

It is reported that in the sugar sector, the sugar juice resulting from purification has a 15 % dry matter content and it is necessary to raise this dry matter content to extract the sugar. The evaporation process allows the dry matter content to be increased from 15 to more than 68 %. It is based on the principle of heat-exchange between the sugar juice and the steam produced in a boiler. A multistage evaporator produces the heat-exchange that takes place between the sugar juice and the low pressure steam. This recycles the steam obtained from the juice after the first exchange. In practice, the low pressure steam from the generator is condensed after undergoing a heat-exchange and returns to supply the boiler. Following the same exchange, part of the water of the sugar juice evaporates and the steam produced in this way heats the second effect, in which a new part of the water evaporates. The effects follow on from each other in this way. The operation can be repeated up to six times in all. A decreasing level of pressure and temperature from one effect to the other allows the operation to be repeated several times with approximately the same amount of energy.

An example large dairy produces dried products, fresh products, semi-hard cheese and butter. The total quantity of milk processed in 2000 was around 321000 litres and the total production of milk and whey powder amounted to around 19000 tonnes. In this dairy, both a single-stage evaporator and a 5 stage falling film evaporator are used. The single-stage evaporator has an input capacity of 30000 l/h and uses an MVR for pre-concentration and a TVR for concentration. The 5 stage evaporator has an input capacity of 22000 l/h and uses a TVR for pre-concentration and concentration. Energy savings were reported using the 5 stage evaporator.

Applicability

Applicable in the sugar industry; in starch processing; in tomato, apple and citrus juice concentration; and in the evaporation of milk and whey.

Reference literature

[39, Verband der Deutschen Milchwirtschaft (German Dairy Association), 2001, 61, CEFS, 2001, 65, Germany, 2002]

4.2.9.2 Vapour compression/recompression

By compressing exhaust vapours, it is possible to make major cuts in energy requirements for concentration processes in the FDM sector. For example, in wort boiling in breweries, the water vapour is given off when a solution is concentrated by condensation. The heat which is put in to evaporate the water and concentrate the solution, can be recovered by condensing the vapour that is driven off. Some common types of compressors used are rotary compressors, screw compressors, radial-flow turbo compressors and blowers.

To enable the heat of condensation stored in the vapour to be used to provide additional heat for the concentration process, condensation of the vapour must take place at a temperature higher than the boiling point. To raise the condensation temperature, the vapour is compressed by 0.1 - 0.5 bar (0.1 – 0.5 hPa). A heat-exchanger is then used to return the heat of condensation from the compressed vapour to the concentration unit.

Apart from the energy needed to drive the compressor, no further energy input is required. The ratio of recovered energy to energy input, i.e. the performance figure, may be as high as 40. In addition to saving energy and reducing energy costs, another important reason for condensing vapours is to reduce odour emissions.

The feasibility of installing vapour compressing techniques greatly depends on the investment costs and the payback due to lower operating costs. Different and changing energy costs in different countries may also influence the decision. In some sectors, operation is seasonal, e.g. 50 days for tomatoes and, therefore, the length of the campaign is also an important factor.

4.2.9.2.1 Mechanical vapour recompression (MVR)

Description

The evaporated vapour is compressed by a mechanical compressor and then re-used as a heat source. The latent heat is higher than the power input of the compressor and a large COP is available. With MVR, all the vapour is compressed, so a high degree of heat recovery is achieved. The system is driven by electricity, but needs a steam heated “finisher” to attain high temperatures. Two types of compressors are in operation, i.e. a fan and a high speed turbine. In practice, the fan is the most widely used compressor type as it has better energy efficiency. The principle of an MVR operation is shown in Figure 4.14.

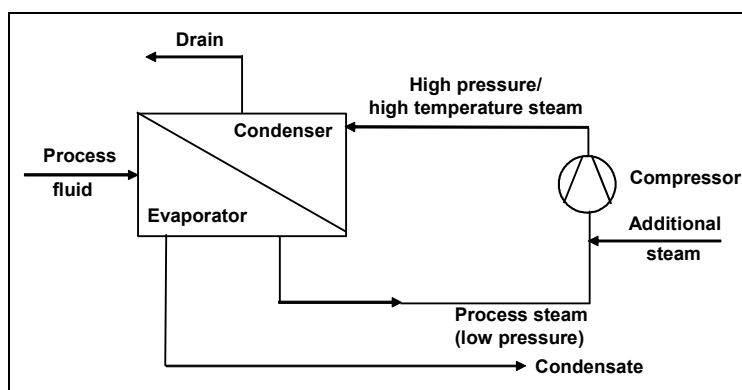

Figure 4.14: MVR evaporator principle

Achieved environmental benefits

Reduced odour emissions. Reduced energy consumption compared to TVR (see Section 4.2.9.2.2). Reduced cleaning requirements due to less build-up of burned product.

Cross-media effects

Electricity is needed to power the vapour compressor. MVR generates noise, so sound insulation is required.

Operational data

It is reported that the energy consumption of an MVR evaporator is approximately 10 kWh/t of water evaporated, with negligible steam consumption. As all of the vapour is recompressed, rather than just a portion of it, as is the case with TVR evaporators, a higher degree of heat recovery is achieved. Also, a lower evaporation temperature is needed, which means less product burnout. Table 4.20 shows that higher energy savings can be undertaken using MVR compared to TVR.

An example Japanese dairy upgraded its milk powder process and installed a 4 stage MVR evaporator to replace its existing 4 stage TVR evaporator. When the MVR system was adopted, it was necessary to both maintain the designed evaporation capacity and to prevent milk being scorched and contaminating the surfaces of the heat transfer pipes in the evaporator. A falling film evaporator and an automated control system to control operating parameters, e.g. flowrate, temperature and pressure, were installed. The MVR has operated successfully with an overhaul every 2 years. Savings in the operating costs of up to 75 % were achieved, mainly as a result of the reduced steam consumption. Figure 4.15 illustrates the new 4 stage MVR evaporator.

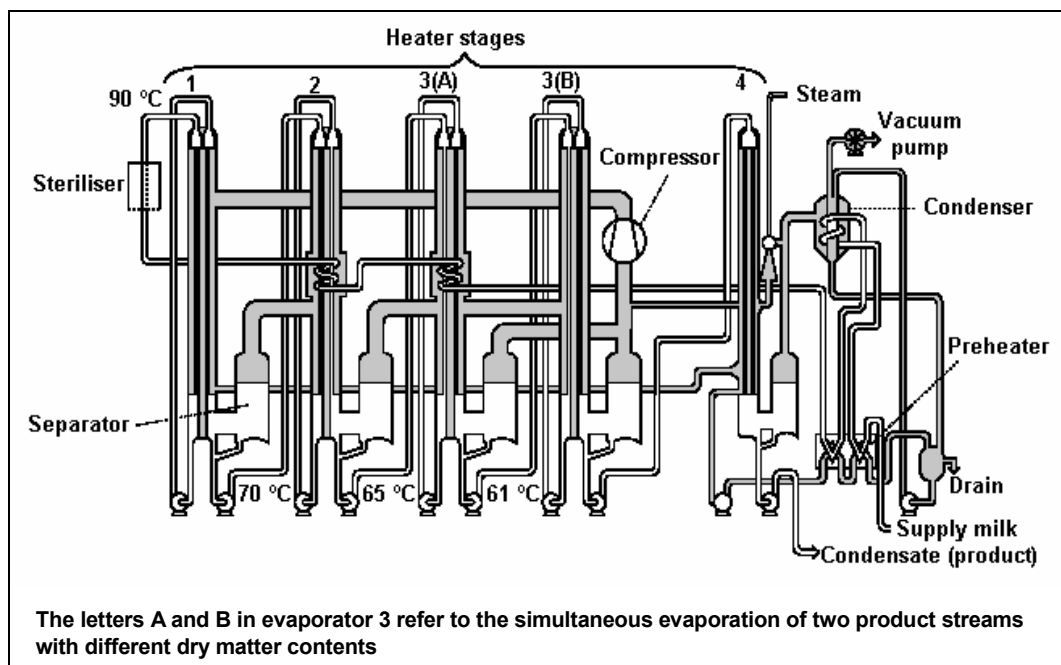

Figure 4.15: Flowchart of a 4 stage MVR milk evaporator system

In an example Finnish dairy, an MVR system draws all the vapour out of the evaporator and compresses it using mechanical energy before returning it to the evaporator. No thermal energy is supplied, except for the steam required for the start-up. The only electricity required is for the operation of the evaporator. In this installation, the MVR can evaporate 100 – 125 kg of water using 1 kW of energy.

In an example brewery in Germany, the vapour condensation system draws off the boiling vapours produced by the wort boiling process from the whirlpool pan and compresses them with MVR. The compressed vapours are re-used as a heating medium for the boiling process. The advantages of condensing the vapours include reductions in the heat and water losses, improvements in the hot water balance of the operation and reduction in odour emissions. It is reported that approximately 1/3 of the electrical energy consumed by the brewhouse has to be used to drive the vapour compressor system.

Applicability

Applicable in sugar manufacturing; starch processing; tomato, apple and citrus juice concentration; brewing and in the evaporation of milk and whey. Most new evaporators are equipped with an MVR system.

Economics

As MVR systems are driven by electricity rather than steam, operating costs are considerably lower compared to TVR. For example, the operating costs of a 3 stage MVR evaporator are approximately half of those of a conventional 7 stage TVR evaporator. The difference in running costs for TVR and MVR increases with the capacity of the evaporator, as illustrated in Figure 4.16.

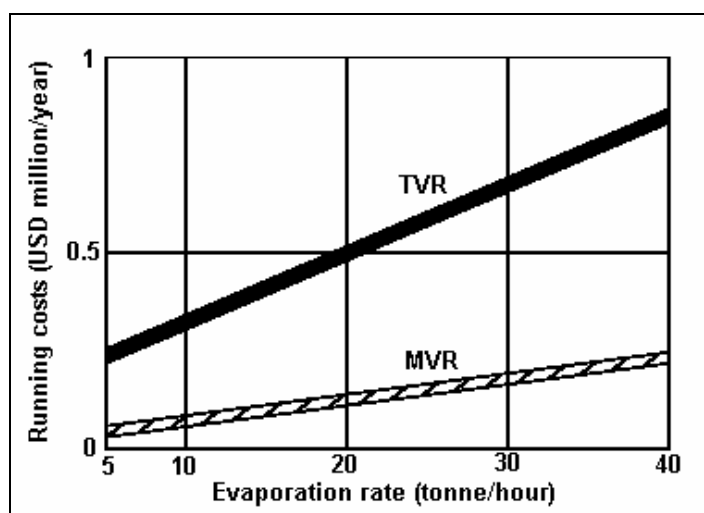

Figure 4.16: Comparison of the operating costs of TVR and MVR evaporators

In the example Japanese dairy, the cost of the new MVR evaporator was EUR 1.5 million, compared with EUR 1.3 million for a new TVR evaporator. At an evaporation rate of 30 t/h, the annual operating costs of the MVR evaporator was EUR 175000, compared with previous annual operating costs of EUR 680000 for the TVR evaporator, i.e. savings of nearly 75 %.

Example plants

Dairies in Japan and Finland and a large brewery in Germany.

Reference literature

[39, Verband der Deutschen Milchwirtschaft (German Dairy Association), 2001, 42, Nordic Council of Ministers, et al., 2001, 65, Germany, 2002, 70, UNEP, et al., 2000, 128, CADDET Energy Efficiency, 1992]

4.2.9.2.2 Thermal vapour recompression (TVR)

Description

TVR makes use of steam injection compressors to compress the vapour. Steam injection compressors may have fixed or variable injection nozzles. The thermal energy needed for compression is live steam from a boiler.

The live steam passes through the injection nozzle and is throttled to the pressure level of the receiving vapour. Vapour is entrained as a result of the difference in speed. Vapour and live steam are mixed in the mixing chamber. Changing the flow aperture in the diffuser determines the pressure at which the mixed steam leaves the steam injection compressor.

Achieved environmental benefits

Reduced odour emissions.

Cross-media effects

Higher energy consumption than MVR.

Operational data

By comparison with MVR, TVR offers advantages of having no moving parts and greater reliability in operation. It is reported that TVR allows for long production cycles and a reduction in cleaning frequency.

Applicability

Applicable in sugar manufacturing; starch processing; tomato, apple and citrus juice concentration; brewing and in the evaporation of milk and whey.

Economics

Lower purchase cost but higher operating costs than MVR.

Reference literature

[39, Verband der Deutschen Milchwirtschaft (German Dairy Association), 2001, 65, Germany, 2002, 128, CADDET Energy Efficiency, 1992]

4.2.10 Cooling

Further information on cooling is available in the “Cooling BREF” [67, EC, 2001].

4.2.10.1 Using a plate heat-exchanger for precooling ice-water with ammonia

Description

Ice-water is used as a cooling medium, e.g. for cooling milk and vegetables. The amount of energy consumed for the production of ice-water can be reduced by installing a plate heat-exchanger to precool the returning ice-water with ammonia, prior to a final cooling in an accumulating ice-water tank with a coil evaporator. This is based on the fact that the evaporation temperature of ammonia is higher in a plate cooler than when evaporator coils are used, i.e. $-1.5\text{ }^{\circ}\text{C}$ instead of $-11.5\text{ }^{\circ}\text{C}$.

Achieved environmental benefits

Reduced energy consumption.

Cross-media effects

Using ammonia involves safety risks. Leakages can be prevented by proper design, operation and maintenance.

Operational data

It is reported that the capacity of an existing ice-water system can be increased without the need to increase the compressor capacity by installing a plate cooler for precooling the returning ice-water.

In an example dairy, this precooling system saved almost 20 % of electricity when installed in an existing ice-water system.

Applicability

This cooling system is commonly applied in new installations, but it can also be applied in existing installations.

Economics

The price depends on the existing ice-water system and capacity. In an example dairy, the investment costs were estimated to be approximately EUR 50000, including a plate cooler, a pump, valves, regulators, pipework and installation.

Driving force for implementation

Reduced consumption of electrical energy and/or increased cooling capacity, without the need for an investment in a new ice-water tank.

Example plants

A dairy in Sweden.

Reference literature

[42, Nordic Council of Ministers, et al., 2001]

4.2.10.2 Using cold water from a river or lake for precooling ice-water

Description

Ice-water is used as a cooling medium, e.g. for cooling milk and vegetables. Cold water from a river or lake can be used for precooling ice-water.

Achieved environmental benefits

The electrical energy consumption is reduced to some extent, depending on the temperature of the river-water.

Cross-media effects

Energy is needed for pumping the water to the cooling tower. The river-water returns unpolluted but with a slightly increased temperature.

Operational data

In an example dairy, cold river-water is pumped into a cooling tower, where the warm water of a closed ice-water system is pre-cooled prior to final cooling in a an ice-water tank. The river water is then led back into the river. The system saves cooling energy corresponding to a temperature decrease of 7 – 10 °C.

Applicability

Applicable when the installation is located near a river with cold water.

Economics

The system requires pipelines from the river and back, as well as an efficient pumping system and a storage tank. An example dairy reports investment costs of approximately EUR 230000 and annual savings of approximately EUR 23000.

Driving force for implementation

Reduced energy costs.

Example plants

A dairy in Sweden.

Reference literature

[42, Nordic Council of Ministers, et al., 2001]

4.2.10.3 Closed-circuit cooling

Description

Water is used to cool, e.g. a pasteuriser or a fermenter. The water is recirculated via a cooling tower or a cooler connected to a central refrigeration plant, i.e. it is re-chilled and returned to the equipment being cooled. If there is a need to prevent algae or bacterial growth, chemicals may be added to the recirculated water. Otherwise, the cooling water can be re-used for cleaning purposes.

Achieved environmental benefits

Reduced water consumption and reduced waste water treatment.

Cross-media effects

Energy may be consumed to cool the cooling water. It may be possible to recover some of this heat.

Operational data

It is reported that closed-circuit cooling can save 80 % of water consumption, compared to an open system. This may be significant in areas where water is not readily available. Once-through cooling water which does not contact the FDM materials will not entrain contaminants and may be considered for direct discharge to receiving waters, however, it will carry a thermal load. Passing once-through uncontaminated cooling water through a WWTP both increases energy consumption and causes dilution, without decreasing the overall load, so direct discharge is advantageous.

In recirculating cooling tower systems, the cooling water is recycled constantly through a cooling tower. However, running the water over the cooling tower maintains a high dissolved oxygen level which can cause corrosion within the system, and evaporation of water at the tower can cause the build-up of suspended solids. The recirculating water may, therefore, require treatment to prevent corrosion and some of the water needs to be discharged periodically to prevent build-up of excess dissolved solids. Precautions also need to be taken to control the conditions for growth of *Legionella* bacteria, which may make the spray from cooling towers a possible source of legionnaires' disease. Closed-circuit systems minimise corrosion and there is no build-up of dissolved solids.

If a large water source, such as a large volume flow river is available, then the cross-media effects associated with closed-circuit cooling may be greater. If the river can provide the volume required and accept the thermal load without significant harm to aquatic life or not interfering with other users of receiving surface water and the water does not become contaminated then once-through cooling may be a better environmental option. Once-through cooling water will also require energy to pump it from its source and out of the installation. If care is not taken to prevent leaks from the system being cooled, then contaminated water may be discharged.

In an example brewery with a capacity of 500000 hl/yr, a closed-circuit cooling system was introduced in a tunnel pasteurisation unit to replace an open system which cooled using fresh water. The reduction in water consumption was estimated to be 50000 m³/yr.

For fermenter cooling, closed-circuit cooling using a chiller and a recirculation pump is reported to result in improved cooling.

In sugar production, cooling water is used on-site for electricity generating turbines. Typically, cooling water will have been abstracted from a river and will pass around a turbine once before it is discharged back to the river.

Applicability

Applicable in dairies, breweries, soft drinks manufacturing and sugar production from sugar beet.

Economics

In a fermenter, the potential cost was reported to be medium, but the payback time short.

In the reported brewery example above, the investment cost of the installation of the cooling tower and other necessary equipment was USD 45000 (before 1996) and the payback period was approximately a year.

Driving force for implementation

Reduced water consumption and subsequently reduced waste water and the associated financial savings.

Reference literature

[13, Environment Agency of England and Wales, 2000, 23, Envirowise (UK) and Dames & Moore Ltd, 1998, 59, Danbrew Ltd., 1996, 222, CIAA-Federalimentare, 2003, 223, Italy M. Frey, 2003]

4.2.11 Freezing

For related techniques under refrigeration, see Section 4.2.15.

4.2.11.1 Energy efficiency in deep freezing

The major energy savings can be achieved in cooling and freezing. Savings are possible by correct adjustment of the working parameters, such as the evaporator temperature, conveyor belt speed and blower power in the freezing tunnel. These depend on the product being processed and the throughput. The consumption of energy in electrical systems in the freezing tunnel can be kept as low as possible by opting for frequency converters (see Section 4.2.13.9) on the blowers, on the distributor conveyor and by installing high efficiency low energy lighting.

4.2.11.2 Lowering condensation pressure

Description

The efficiency or the COP of the freezer unit is mainly determined by the evaporator pressure and the condensation pressure. The reduction of condensation pressure raises the COP and lowers the electricity consumption. The condensation pressure is kept as low as possible by providing sufficient condenser units.

Achieved environmental benefits

Reduced energy consumption.

Applicability

Applied in the deep freezing and refrigeration of packaged and unpackaged food products.

Reference literature

[31, VITO, et al., 2001, 32, Van Bael J., 1998]

4.2.11.3 Lowering condensation temperature

Description

The reduction of condensation temperature raises the COP and lowers the electricity consumption. This reduction can be achieved by fitting an adequate capacity of condenser batteries so that, even in summer, which is high season for the vegetable sector, sufficiently low condensation temperatures can be achieved.

Low temperatures can also be achieved by keeping the condensers clean and replacing badly corroded ones. Blocked condensers cause the condensing temperature to increase and the cooling capacity also drops, so the required temperature may not be achieved.

Ensuring that air entering the condensers is as cold as possible also contributes to lowering the condensation temperature. The warmer the air entering the condenser then the higher the condensing temperature is. This can be minimised by shading the condensers if necessary, ensuring that warm air is not recirculated, removing anything which obstructs the airflow and freezing at night.

Achieved environmental benefits

Reduced energy consumption.

Operational data

Lowering the condensation temperature by 1 °C raises the COP by 2 %. Lowering the condensation temperature by 5 °C causes the electricity consumption to fall by 10 %.

Applicability

Applied in the deep freezing and refrigeration of packaged and unpackaged food products.

Reference literature

[32, Van Bael J., 1998, 69, Environment Agency of England and Wales, 2001]

4.2.11.4 Raising evaporation temperature

Description

Raising the evaporation temperature improves energy performance. To do this, a simultaneous optimisation of various freezing tunnels can be carried out, as shown in Figure 4.17. This optimisation needs to be undertaken again after a tunnel is shut down, a different product is processed and another flowrate is set.

Achieved environmental benefits

Reduced energy consumption.

Operational data

It is reported that if the evaporator temperature is raised by 1 °C, the COP rises by 4 % and the refrigeration capacity rises by 6 %.

A Flemish study on energy consumption during the freezing of vegetables in a freezing tunnel, showed that the greatest savings can be achieved by adjusting the evaporator temperature, the residence time of the vegetables in the freezing tunnel, the airflowrates relative to the vegetable flowrate and the type of vegetables. This study shows that it is not always necessary to set the evaporator temperature at the lowest level, i.e. -40 °C, for good freezing quality. Furthermore, it is very important to monitor the temperature of the product after it has gone through the freezing tunnel. Low temperatures, i.e. <-18 °C, are not necessary as the vegetables will ultimately be stored in a confined space at -18 °C. High temperatures, i.e. >-16 °C, lead to lower freezing qualities. In a worst case scenario, the whole mass can freeze together during storage in crates. The conclusions of the study are summarised in Figure 4.17.

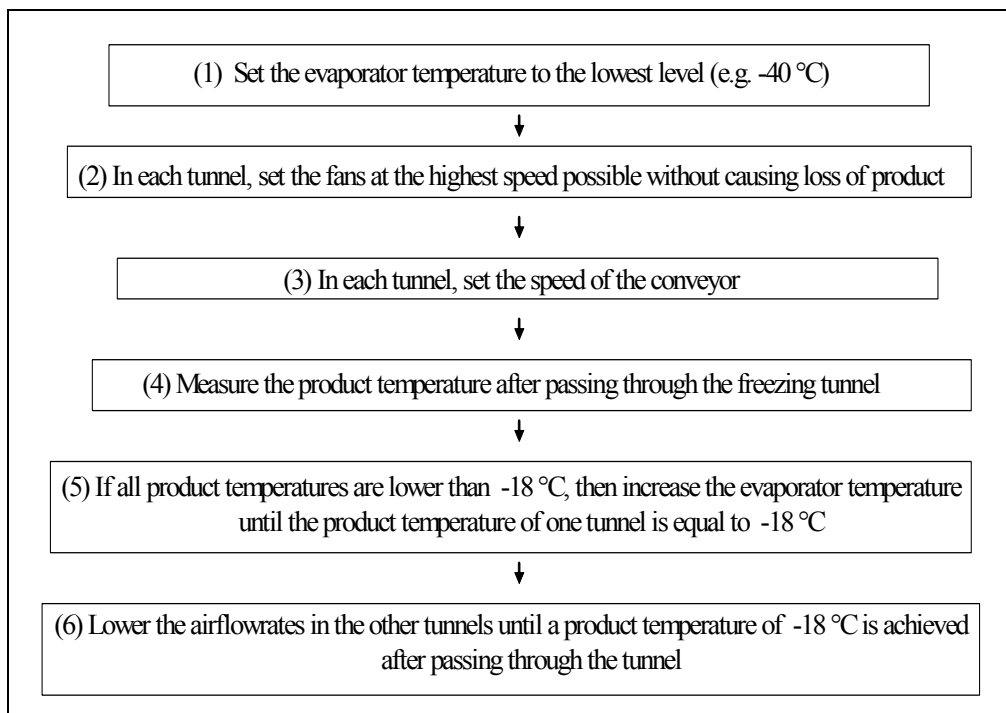

Figure 4.17: Optimising the freezing tunnels in the production of deep frozen vegetables

With reference to Figure 4.17:

- 1) The evaporator temperature of the freezing unit is set to the lowest position, e.g. -40 °C.
- 2) The fans are set to the maximum airflow rate permissible without product loss. If the air regulating valves are fully opened or the rotation speed adjustment is set at maximum frequency, product is blasted out of the bed. Then, the valves are closed more or the frequency is lowered.
- 3) In adjusting the speed of the conveyor belt, inversely proportional to the residence time on the belt, care is taken to ensure that the layer thickness is not too low. This always leads to the formation of preferential air channels in the vegetable bed, which means that the rest of the bed receives little airflow. The layer thickness is not set too high either, since this leads to block freezing of the lower layers. As the pressure drop over the vegetable bed rises, the air speeds fall with lower heat removal.
- 4) The product temperature in each freezing tunnel is measured. To take the measurement, an insulated container is filled with product. The reading is taken as soon as the temperature stabilises. Immediately after freezing, the outer temperature has a lower temperature than the centre.
- 5) If the product temperature is lower than -18 °C for each of the tunnels, then the evaporator temperature is set higher. This is repeated until the product temperature of one of the freezing tunnels is equal to -18 °C. If, in one of the tunnels, the product temperature at the lowest position of the evaporator is higher than -18 °C, then the vegetable flow rate of the tunnel concerned is lowered.
- 6) In the other freezing tunnels, the airflow rate is lowered if a product temperature of -18 °C is achieved.

Applicability

Applicable to the deep freezing of packaged and unpackaged food products.

Reference literature

[31, VITO, et al., 2001, 32, Van Bael J., 1998]

4.2.11.5 Using high efficiency motors for driving fans

Description

The motors for driving the fans are set up in the freezing tunnel. The electrical energy supplied to the motors must, therefore, be dissipated by the freezer unit. By opting for high efficiency motors for driving the fans, not only is there a direct saving in electricity, e.g. lower consumption by the fans, but also an indirect saving, e.g. through the lower cooling load on the refrigeration unit.

Achieved environmental benefits

Reduced energy consumption.

Applicability

Applied in the deep freezing of packaged and unpackaged food products.

Reference literature

[31, VITO, et al., 2001, 32, Van Bael J., 1998]

4.2.11.6 Reducing the fan output during short production stops

Description

When freezing food, there are regularly problems with the supply to the freezer in a processing step or when switching from one product to another. During these periods, it is nevertheless important to keep the empty freezing tunnel at a sufficiently low internal temperature. For this to occur, the fans need to be kept running, but the airflow rates can be reduced. To do this, motors with regulated rotation speeds can be switched to the lowest possible frequency. In addition, a number of fans can be switched off. This reduces the energy consumption of the fans and of the refrigeration unit.

Achieved environmental benefits

Reduced energy consumption.

Operational data

Any reduction in the fan power by 1 kW_e results in a total saving of 1.4 – 1.6 kW_e.

Applicability

Applied in the deep freezing of packaged and unpackaged food products.

Reference literature

[31, VITO, et al., 2001, 32, Van Bael J., 1998]

4.2.11.7 Operating without automatic defrosting during short production stops

Description

When freezing food, there are regularly problems with the supply to the freezer in a processing step or when switching from one product to another. During these periods, it is nevertheless important to keep the empty freezing tunnel at a sufficiently low internal temperature. To reduce energy consumption during these stops, the automatic defrosting of the evaporators can be switched off as, in an empty freezing tunnel, there is little or no transport of moisture or water, e.g. water is only transported with the food entrance and exit. This avoids re-cooling the evaporator after defrosting.

Achieved environmental benefits

Reduced energy consumption.

Operational data

An example evaporator weighs approximately 2 tonnes and is made of steel. To cool this mass again from 15 to -35 °C takes about 13.33 kWh (48 MJ) of refrigeration. Thus, switching off the automatic defrosting during short production stops yields a saving in the compressor consumption, i.e. savings of 5 to 9 kWh_e can be made per evaporator that is not defrosted.

Applicability

Applied in the deep freezing of packaged and unpackaged food products.

Reference literature

[31, VITO, et al., 2001, 32, Van Bael J., 1998]

4.2.12 Packing and filling

For the purpose of this document, the minimisation of packaging waste associated with the production process is undertaken.

Extensive packaging is used throughout the FDM sector as products must be packaged appropriately for the distributor and consumer for hygiene, to convey information, be attractive to the consumer and to protect the product and also for, displaying a brand name, and presenting a high visibility in often very competitive markets [47, Envirowise (UK) and Aspinwall & Co., 1999]. This includes both bulk and individual packaging. Hygiene principles need to be considered, e.g. by following HACCP principles.

In the UK, the FDM sector is responsible for using over 50 % of the total yearly packaging (4 - 5 million tonnes per year). This packaging has a value of approximately GBP 4000 million for raw materials alone. On average, packaging represents 13 % of the UK sector's production costs [47, Envirowise (UK) and Aspinwall & Co., 1999].

4.2.12.1 Selection of packaging materials

Description

The life-cycle analysis of packaging is beyond the scope of this document.

Packaging materials can be selected to minimise the environmental impact. To keep waste to a minimum, the weight and volume of each material, together with its recycled content, need to be considered, as does the potential for re-use, recycling and disposal of the packaging. Often one material can replace the need for another, e.g. recyclable shrink-wrap could replace the need for cardboard trays and shrink-wrap.

The choice of packaging material can affect the potential for it to be re-used both within the installation and outside, e.g. after refilling at the supplier's premises.

It is possible to select easily recyclable materials; to try not to use composite materials; to label packaging to indicate materials used and to reduce cross-contamination of materials, e.g. paper labels on plastic sleeves. This requires collaboration between the packaging manufacturer or supplier to the FDM installation and, in most cases, the downstream customer, especially if they are a retailer. A caterer may more readily accept bulk deliveries and not require eye catching packaging.

The selection of packaging materials needs to be based on the essential requirements in Article 9 and Annex II of Directive 94/62/EC on packaging and packaging waste [213, EC, 1994]. This includes minimising the presence of noxious and other hazardous substances and materials with regard to their presence in emissions, ash or leachate when packaging or residues if they are finally incinerated or landfilled. Recycling of packaging can give rise to emissions to the environment as a result of the materials of construction and also from the residues of the product they contained. There are limits on the levels of cadmium, mercury, lead and hexavalent chromium allowed. The suitability for recovery by material recycling and/or composting, i.e. its biodegradability and/or energy recovery, i.e. its calorific value have to be considered. Directive 94/62/EC sets out further details. The emptying, collection, sorting, separation and recycling necessary for subsequent re-use of the recovered materials are affected by the materials and combination of materials used.

For example, natural materials such as wood, wood fibre, cotton fibre, paper pulp and jute which have not been chemically modified can be accepted as being biodegradable without further testing.

Achieved environmental benefits

Decreased consumption of non-renewable materials and reduced waste generation.

Cross-media effects

Packaging designed for re-use is often heavier than equivalent single use packaging, so additional energy may be required for its handling and transportation. Packaging which can come into contact with the product needs to be cleaned before it is re-used, so water and cleaning agents are consumed and waste water is generated.

Applicability

Applicable to all FDM installations.

Economics

Reduced waste disposal costs.

Driving force for implementation

Legislation and in particular Directive 94/62/EC.

Reference literature

[64, Environment Agency of England and Wales, 2001, 213, EC, 1994]

4.2.12.2 Optimisation of packaging design – to reduce the quantity

Description

The life-cycle analysis of packaging is beyond the scope of this document.

Pollution prevention with respect to waste packaging is addressed using the waste minimisation hierarchy, hence by avoiding packaging; reducing packaging; re-using packaging; and by recycling packaging.

The optimum amount of primary and secondary packaging can be used, taking account of product size, shape, weight, distribution requirements and packaging material selected. The packaging can be selected to fit the purpose, minimise the amount of packaging material used, maximise the amount of product per pallet and optimise warehouse storage. This can be done whilst ensuring that the packaging continues to provide the required degree of protection for the product and without increasing the risk of product waste.

The choice of packaging and packaging materials needs to be based on the essential requirements in Article 9 and Annex II of Directive 94/62/EC on packaging and packaging waste [213, EC, 1994]. One way towards compliance is to work to harmonised standards such as EN 13428 Packaging – Requirements specific to manufacturing and composition – prevention by source reduction (working to this standard does achieve compliance with the third indent of Annex II(1) of the Directive) and EN 13432 Packaging – Requirements for packaging recoverable through composting and biodegradation – Test scheme and evaluation criteria for the final acceptance of packaging. At the time of writing, further harmonised standards are under preparation.

Achieved environmental benefits

Reduction in consumption of materials for packaging and reduced waste both at the installation and at the place of unpacking.

Operational data

A confectionery company invested in a new wrapping machine which enabled it to eliminate the inner collation wraps on its bumper packs of biscuits. Polypropylene use was consequently reduced by 100 t/yr.

A petfoods company lowered the sides of its cardboard transit trays, without loss of strength. This action reduced wastage and resulted in a 49 % reduction in the use of corrugated card and ink.

In a preserves and peanut butter factory, a packing line study identified that static electricity associated with the sleeve film affected the availability of the automated tamper-proofing sleeve machine. By increasing the film thickness by 20 μm , the machine speed could be maintained at 250 jars per minute and stoppages reduced by 40 %. Savings in film waste alone equated to GBP 25000/yr.

Applicability

Widely applicable.

Economics

The confectionery company reported a payback period of under 2 years. The petfoods company reported annual savings of GBP 100000.

Driving force for implementation

Reduced packaging use.

Example plants

A biscuit manufacturer and a petfoods manufacturer.

Reference literature

[11, Environment Agency of England and Wales, 2000, 31, VITO, et al., 2001]

4.2.12.3 Segregation of packaging materials to optimise use, re-use, recovery, recycling and disposal

Description

Suppliers of raw materials, additives and cleaning chemicals may take back their empty containers, made from, e.g. plastic, wood or metal, for recycling. This may be easier for the operator of the installation and the supplier, if they arrange for use of the largest size container possible. In addition, used packaging materials, if separated from other materials, may be sent for recycling if they cannot be re-used.

The segregation of packaging waste can produce opportunities for recycling waste and reducing the volumes sent to landfill. It may even be sold. This process can be as simple as putting, e.g. paper, wood, plastics and food, into separate skips. Alternatively, it can involve a more complex process, such as using a macerator, to help to separate packaging from product.

For example, the protective plastic film around bottles supplied to bottling lines can be collected, pressed into bales and sent for recycling.

Achieved environmental benefits

Prevents waste and facilitates recycling of both packaging and FDM materials.

Cross-media effects

If empty containers are returned without cleaning, no cross-media effects apply. Containers which come into direct contact with food need to meet the required hygiene standards so they will need to be cleaned before they are re-used. This may cause dust emissions, chemical use, waste water and energy consumption. The transport back from the user to the supplier involves an environmental cost.

Operational data

A dessert manufacturer developed a machine in-house to separate waste end-of-line product from its packaging. This enabled plastic carton packaging to be compacted and recycled, and for the solid product waste to be mixed with liquid food waste and sold as pig feed. The result was reduced waste, and lower waste disposal and waste water treatment charges.

Bottles, casks, kegs, plastic and metal crates, intermediate bulk containers, pallets, drums, plastic boxes and plastic trays can be re-used. Cardboard, paper, plastic, glass and metals can be recycled. These packaging materials can be collected at the point in the installation where they are emptied.

For the packaging to be re-used, it is necessary for companies to have arrangements, such as a closed-loop system, where back-haulage allows the packaging to be returned for re-use. It is reported that this is usually more effective where transportation distances are relatively short. The use of a tracking system, e.g. using bar codes, could aid the management of transit packaging.

Applicability

Applicable in all new and existing FDM installations using a variety of packaging materials.

Economics

Economic data differ from site to site and depend on the conditions agreed with the supplier and/or the recycling operator. Waste disposal and waste treatment charges are reduced.

Driving force for implementation

Prevention and recycling schemes for waste and packaging waste legislation. Reduced waste generation and associated disposal costs.

Example plants

At least one dessert manufacturer in the UK.

Reference literature

[11, Environment Agency of England and Wales, 2000, 31, VITO, et al., 2001]

4.2.12.4 Optimising packing line efficiency

Description

Poorly designed and operated packing lines cause many companies to lose as much as 4 % of their product and packaging. To improve efficiency and productivity and to reduce wastage, individual machines can be correctly specified so that they work together as part of an efficient overall design.

It is important to keep the slowest machine in the production line running at maximum capacity. Ideally it is never starved of feedstock. Packing line efficiency can be monitored, e.g. on a weekly basis by measuring key performance indicators, e.g. the waste to production ratio. The optimum and the actual design values of the packing machine can be plotted to identify if the machinery is operating at optimum efficiency. Other values can also be plotted to show the reliability of individual machines. Key performance indicators could include the number of rejects during a shift or day and downtime.

Achieved environmental benefits

Reduced overall FDM and packaging waste.

Cross-media effects

Usually none, however, one of the examples quoted in the operational data section below used a thicker film, but this was outweighed by the savings in waste.

Operational data

In an example large brewery, to combat poor packing line efficiency, teams were set up to monitor performance and identify problem areas. An understanding of the packing lines enabled actions to be taken to reduce stoppages and to increase efficiency. This action resulted in reduced operating costs and wastage, producing cost savings in excess of GBP 137000/yr.

A study in a dairy identified that packing line sensors on a bottle top shoot were too close to the base filler. This caused the sensors to become covered by milk froth and unable to detect bottle top blockages. This caused the rejection of up to 20000 bottles per week. By repositioning the sensors, the company was able to save GBP 35000/yr in disposal costs from spoilt poly-bottles and a further GBP 5000/yr in milk waste and reprocessing costs, together with benefits in increased production.

Applicability

Applicable to all FDM installations, i.e. new and existing, which have automated filling machines.

Economics

See savings reported from example plants, under Operational data, above.

Driving force for implementation

Reduced wasted product and packaging and associated cost savings.

Example plants

Widely applied in the FDM and other sectors.

Reference literature

[11, Environment Agency of England and Wales, 2000]

4.2.12.5 Waste minimisation by optimising packing line speedDescription

The performance of packing lines can be optimised and an appropriate machine speed set to ensure that the product is weighed in accurate portions to coincide with the operation of the heat sealing equipment.

Achieved environmental benefits

Reduced wastage of product and packaging.

Operational data

An example sweet manufacturing company monitored its packing lines performance and discovered that an inappropriate machine speed was causing inaccurate weighing of the product and failure of the heat sealing equipment. A simple adjustment of the machine's speed enabled savings to be made in product, packaging, reworking and waste disposal. Other benefits were increased production and a 500 t/yr reduction in waste.

Applicability

Applicable in all FDM companies using form fill seal machines.

Economics

In the example company, savings of over GBP 120000/yr were made. Other financial benefits were associated with an increase in production and the reduction in waste sent to landfill.

Driving forces for implementation

Improved production efficiency.

Example plants

At least one sweet manufacturing company in the UK.

Reference literature

[11, Environment Agency of England and Wales, 2000]

4.2.12.6 Use of in-line check-weighers to prevent overfilling of packagingDescription

Using in-line check-weighers can reduce the amount of product lost due to overflow. Overfilling can lead to product losses due to overflowing and due to the entrance of material intended to be packed which becomes stuck in seals, contaminating them, e.g. in form fill seal machines. This can lead to spillages and the need to reject products. Techniques such as statistical process control may be used to monitor overfill and to identify when the machinery requires adjustment. This can also be achieved by a vigilant trained operator maintaining the optimal settings on the filling machine.

Achieved environmental benefits

Reduced wastage if overfilling leads to spillage or contamination of packaging seals.

Operational data

On a new machine operating at a fill quantity of 400 g, one standard deviation of 0.5 g, i.e. 0.125 % can be achieved. On older machines this can be even higher, e.g. between 0.15 % and 0.25 %.

Applicability

Applicable in all installations with automatic filling machines.

Economics

Money saved by not putting more in the packet than required to and by reduced losses due to spillage waste.

Driving force for implementation

Compliance with “weights and measures” legislation.

Example plants

Plants, including FDM plants with new filling machines, achieve as low as 0.125 % overfilling and those with old machines can achieve between 0.15 % and 0.25 % overfilling.

Reference literature

[11, Environment Agency of England and Wales, 2000, 198, FPME, 2003]

4.2.13 Energy generation and consumption

4.2.13.1 Combined heat and power generation (CHP) – European overview

The production of electricity through CHP represented 11 % of the EU-15 total electricity production in 1998, leading to energy savings comparable to the annual gross energy consumption of Austria or Greece. A proposal for a Directive aimed at saving energy and combating climate change by promoting CHP was presented by the EC on 23 July 2002 [90, EC, 2002]. The proposed Directive would encourage MSs to promote CHP through a systematic identification and progressive realisation of the national potential for high efficiency CHP. MSs would have to report on the progress achieved towards meeting this potential and on the measures taken in this respect.

4.2.13.1.1 Combined heat and power generation (CHP)

Description

Combined heat and power (CHP) generation, also known as co-generation, is a technique through which heat and electricity are produced in one single process. In-house combined generation of heat and power can be used in food manufacturing processes for which heat and power loads are balanced. For example, sugar manufacturing requires electrical and thermal energy in every step of the process. Electricity is needed for lighting, for plant process control, and as the driving power for machinery. Steam and hot water are needed for heating process vessels and buildings. As the size of dairies increases, the amounts of thermal and electrical energy needed for evaporation/drying steps is growing, making CHP a feasible alternative.

Achieved environmental benefits

Reduced energy consumption and air emissions, e.g. NO_x, CO₂ and SO₂.

Operational data

The energy efficiency of CHP can be as high as 90 %. This optimises the use of fossil fuels and reduces the production of CO₂. New CHP installations save at least 10 % of the fuel otherwise used in the separate production of heat and electricity. Furthermore, gas-fired CHP schemes can eliminate SO₂ emissions and NO_x can be controlled to meet environmental legislation. Modern CHP equipment is likely to require less effort to operate and maintain than many older boiler systems, as they are equipped with automatic control and monitoring systems.

It is reported that most of the energy required in sugar manufacturing is obtained by burning gas, heavy fuel oil or coal in a boiler house, which converts it, by means of CHP equipment, into steam and electricity. In this sector, the overall fuel utilisation factor of CHP exceeds 70 % and is typically above 80 %. This fuel conversion efficiency greatly exceeds that of any design of commercial power stations whose steam is not used further, including even the latest generation of combined cycle gas turbines, which are around 55 % efficient. Excess electricity produced may be sold to other users.

In the dairy sector, it is reported that CHP is a good option as evaporation/drying steps need both electricity and thermal heat in large amounts. For example, CHP is widely used during whey and milk drying, where high steam temperatures and pressures are needed, e.g. 220 - 240 °C and 32 – 34 bar. Losses in the pipe system must also be taken into consideration, so that steam generation must occur at 40 bar minimum. CHP on the basis of a back pressure steam turbine is used. In this type of CHP equipment, the steam pressure difference in the back pressure steam turbine generates mechanical energy for the propulsion of an electric generator. Before whey and milk drying, lower steam temperatures and pressures are needed. This low pressure steam can be provided either by steam pressure reduction with throttle valves or by CHP on the basis of a back pressure steam turbine. The CHP option is more energy efficient as steam pressure reduction with throttle valves “destroys” energy.

If drying is not carried out in the dairy and the required steam temperatures and pressures are considerably lower, the back pressure steam turbine is not useful because the steam pressure head is too small which results in poor efficiency. In these cases, block-type thermal power stations with gas or diesel engines, or CHP equipment with gas turbines and downstream waste heat boilers, are reported to be more appropriate. Figure 4.18 shows Sankey diagrams comparing energy efficiencies in a conventionally operated gas turbine and generator and CHP equipment in a dairy.

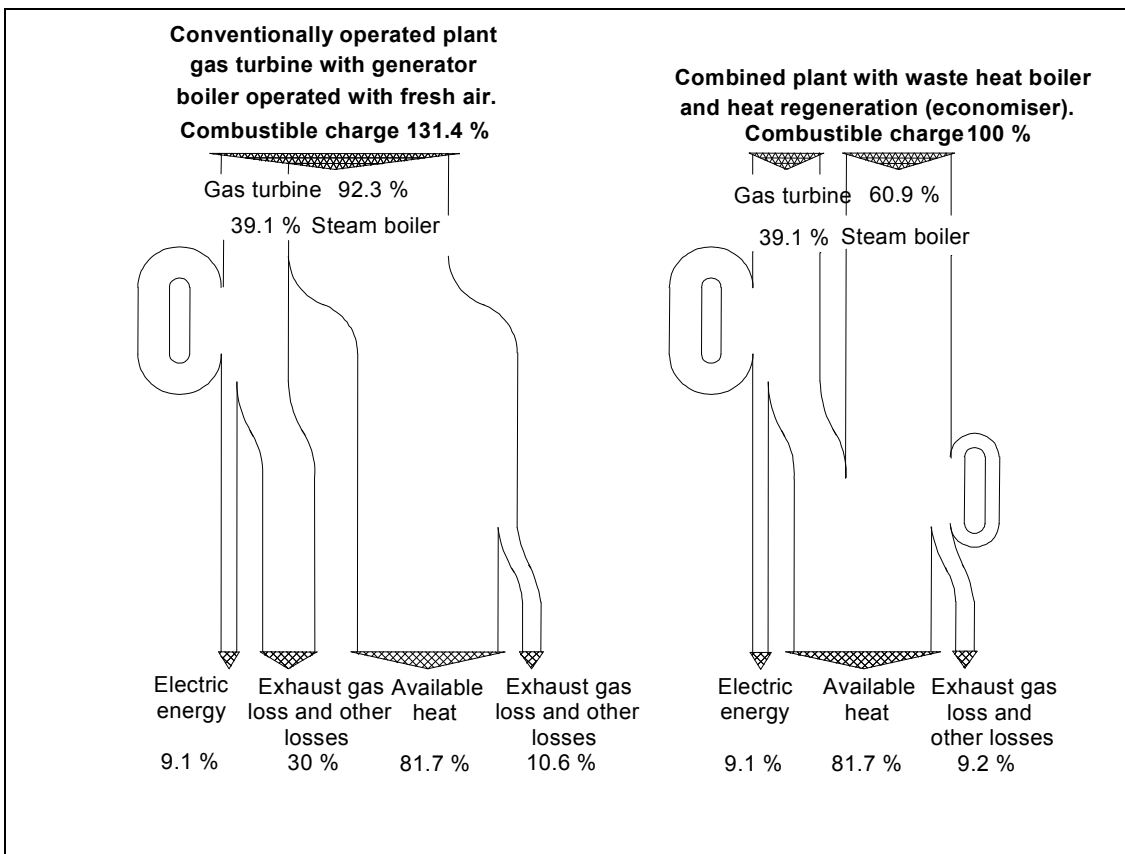

Figure 4.18: Comparison of energy efficiencies between a conventionally operated gas turbine generator and CHP

In an example brewery, a CHP system generates electrical power using a 4000 kW_e gas turbine generator. High pressure steam at 1.5 MPa is produced from exhaust gas from the turbine using an 11 t/h exhaust gas boiler. This steam merges with high pressure steam from existing boilers, and runs a back pressure steam turbine-driven refrigerating machine with a 734 kW_{th} capacity. Exhaust steam from the back pressure turbine, with a pressure lowered to 0.6 MPa, is used as the heat source driving an ammonia absorption refrigerating machine with a 1.93 kW_{th} capacity, which supplies a secondary refrigerant, e.g. brine, used for cooling beer. The system thus makes cascading use of energy from steam and reduces the brewery's electrical demand by 820 kW in total, 220 kW for the steam turbine-driven engine and 600 kW for the ammonia absorption refrigerator. If the process is run batch wise, the demand for steam is not constant. In this case, if a steam turbine-driven refrigerator alone was used to produce energy to chill, its availability would largely depend on this unstable demand for steam. This system can reportedly be used in ice-cream manufacturing installations, as they also consume large amounts of electricity and energy to chill. Figure 4.19 shows a flow sheet of this CHP system in a brewery.

Economics

A decision on whether to implement CHP based on investigation of the economic aspects will take account of the price of gas and electricity. A balance of relatively expensive gas or other fuels and cheap electricity mitigates against the selection of CHP. For example, if electricity prices fall or gas prices rise, the financial return from CHP will decrease. This is possible in a free energy market. One option, which is sometimes applied, is to design the CHP installation on the basis of heat consumption with excess electricity being sold to the public grid. Whether this is an attractive option very much depends on the price obtained for the excess electricity that is sold.

With regard to financing of the CHP installation, the tendency is for companies to not finance it themselves. Sometimes joint ventures with energy suppliers are formed and sometimes third parties completely finance the CHP installation. A contract for delivery of electricity and heat by the CHP installation normally runs for 10 to 15 years.

In the UK, it has been found that CHP can now reduce the total energy bills of an installation by 20 %. In the example brewery, the savings in energy costs were 16.2 %.

Example plants

Applied in sugar manufacturing installations, dairies, breweries and distilleries.

Reference literature

[9, Verband der Deutschen Milchwirtschaft (German Dairy Association), 1999, 39, Verband der Deutschen Milchwirtschaft (German Dairy Association), 2001, 61, CEFS, 2001, 69, Environment Agency of England and Wales, 2001, 90, EC, 2002, 92, CADDET Energy Efficiency, 2000]

4.2.13.2 Efficiency of a heat generator

Efficiency is defined as the ratio of energy output to energy input of a process. The efficiency of a heat generator can be described as the ratio between the energy taken up by the fluid which carries the heat and the incoming energy of the fuel, estimated on the lower calorific power. The typical method for calculating the efficiency of the heat generator is the so-called “indirect method”. This method is based on the conventional evaluation of losses through perceivable heat in fumes, incomplete combustion and dispersions from the heat generator walls.

For the evaluation of losses to the chimney and of losses as a result of incomplete combustion, the recourse is generally to measure two of the following parameters, i.e. O₂, CO₂ and CO, and to use these to work out percentage losses by means of an Ostwald combustion diagram.

Losses due to dispersions through the heat generator walls are generally constant with the variation in load and may be evaluated by means of diagrams supplied by boiler manufacturers.

The controls to be carried out to monitor efficiency are the following:

- analyses of fumes and O₂
- use of the fuel and of the air combustion
- pressure, temperature and capacity of the heat carrying medium in the heater, e.g. diathermic oil, and the thermal carrier fluids to the users, e.g. steam or superheated water.

4.2.13.2.1 Improving the efficiency of a heat generator

Description

The indirect method of measuring the efficiency of a heat generator has shown the optimal values for the fume analysis of a methane-fired diathermic oil heater installed in a pasta installation, which produces more than 300 t/d. These are shown in Table 4.21.

O ₂ (percentage by volume in dry fumes)	3 %
CO	<70 mg/Nm ³
Gaseous NO _x	<250 mg/Nm ³

Table 4.21: Optimal values for the fume analysis in a pasta installation

The efficiency of a heat generator may be improved by reducing losses or by increasing the efficiency of the transfer of heat by the heat carrying medium. To reduce losses in the fumes, the temperature of the fumes to the chimney can be lowered, so reducing losses in the form of perceivable heat. Also, the excess air can be regulated to match the needs based on the flow of incoming fuel, to reduce the losses as a result of incomplete combustion.

Achieved environmental benefits

Reduced energy consumption and air emissions.

Operational data

In an example pasta installation, to reduce heat losses through the chimney, i.e. which represented about 50 % of the total losses, the temperature of the fumes to the chimney was lowered. The excess air was regulated to prevent incomplete combustion.

In existing installations, efficiencies could rise from 85 to 90 % with a reduction in CO₂ emission levels from 5.5 to 6.5 %. In new installations, the efficiencies could be higher than 91 % with a reduction in CO₂ emission levels greater than 7.6 %.

In addition, by preheating the combustion air by means of fume recovery, a 2 % increase in efficiency per every 50 °C decrease in the temperature of the fumes was achieved. The temperature of preheated air generally varies between 170 and 200 °C.

For existing heaters with correct combustion, efficiencies of 90 % can be achieved. For new heaters using diathermic oil with fume recovery that preheats the combustion air, efficiency values of 92 % under conditions of economic load and 91 % under conditions of maximum load, can be achieved.

Applicability

Applicable to both new and existing FDM installations.

Economics

The cost of implementation is low for existing installations, but high for new installations.

Example plants

A pasta industry in Italy.

Reference literature

[150, Unione Industriali Pastai Italiani, 2002]

4.2.13.3 Insulation of pipes, vessels and equipment

Description

Insulation of pipes, vessels and equipment such as ovens and freezers can minimise energy consumption. Insulation can be optimised by selecting effective coating materials with low conductivity values and high thickness and by using pipes, vessels and equipment that are insulated prior to installation. Pre-insulation has the advantage that, e.g. the pipe supports are mounted outside of the insulation coating instead of being directly connected. This reduces the heat loss through the mounts.

Insufficient insulation of pipework can lead to excessive heating of the surrounding process areas as well as the risk of burn injuries.

Achieved environmental benefits

Reduced energy consumption and associated fuel consumption and air emissions.

Operational data

Insulation of pipes and tanks can reduce the heat/cold loss by 82 – 86 %. Additionally, 25 - 30 % heat can be saved by using pre-insulated pipes instead of traditionally insulated ones.

Hot and cold products are stored and pumped in dairies. In an example new dairy in Denmark, all of the pipes with a temperature difference of at least 10 °C above ambient temperature were fitted with 30 mm insulation. Tanks were coated with 50 mm insulation. Pre-insulated pipes were used with a coating of mineral wool wrapped in a metal sheet. More than 9 km of pipework and 53 tanks were insulated. The calculated savings in energy were 6361 MWh/yr heating energy and 2397 MWh/yr cold energy, i.e. the equivalent of 479 MWh/yr electricity.

In an example Italian pasta installation, the energy dissipated all along pipework was investigated and the insulation was improved. In three cases, the thermal resistance was increased from 0.22 to 0.396, 0.574 and 0.753 m².°C/W. This resulted in CO₂ emission reductions of 44.4, 61.6 and 70.7 %, respectively.

Applicability

Applicable to all FDM installations, whether new or existing. Pre-insulated pipes are applicable in new installations and where pipework, vessels and equipment are replaced.

Economics

In the example new Danish dairy, the investment cost was about EUR 1408000 with a payback period of 7.6 years.

Driving force for implementation

Reduction in energy costs.

Example plants

Widely applied in the FDM sector and others.

Reference literature

[42, Nordic Council of Ministers, et al., 2001, 150, Unione Industriali Pastai Italiani, 2002]

4.2.13.4 Heat pumps for heat recovery

Description

The working principle of a heat pump is based on heat transfer from a lower temperature to a higher temperature by aid of electrical power. For example, the recovery of heat from warm cooling water. The cooling water is cooled and the heat can be used for heating hot water.

Achieved environmental benefits

Reduced energy consumption, e.g. heat recovery.

Cross-media effects

Heat pumps require electricity.

Operational data

It is reported that in 1997 there were more than 16 food companies in Australia using over 30 heat pump driers for LTD of food materials. The heat pump drier consists of a conventional drying chamber with an air circulation system and the usual components of an air conditioning refrigeration system. The drying air is dehumidified by an evaporator, which is the cooling section of the refrigeration cycle, and reheated by the condenser of the heat pump. The energy efficiency expressed by a specific moisture extraction rate, i.e. kg water removed/kWh energy used, is between 1 – 4, with an average of 2.5 kg/kWh. FBDs are not suitable for sticky materials or if the shape is irregular. The two driers can be used in series. Dehumidified air from the heat pump is directed first to the fluidised bed with the semi dried product. The airflow then passes through the cabinet drier. It is reported that using this combination, energy efficiency can be improved by up to 80 %.

Applicability

A good heat source is needed in combination with a simultaneous need for heat near the source.

Economics

The economic feasibility depends on the price of fuel in relation to that of electrical power.

Driving force for implementation

Reduced costs for energy and water.

Example plants

Several food companies in Australia.

Reference literature

[42, Nordic Council of Ministers, et al., 2001, 73, CADDET UK National team, 1997]

4.2.13.5 Heat recovery from cooling systems

Description

Heat can be recovered from cooling equipment and compressors. This involves the use of heat-exchangers and storage tanks for warm water. Depending on the cooling equipment, 50 – 60 °C temperatures can be achieved.

Achieved environmental benefits

Reduced energy consumption, e.g. heat recovery.

Operational data

It is reported that recovered heat can be used for heating tap water or ventilation air, thawing deep frozen goods, or preheating the cleaning liquids or the product.

The installation of a heat recovery system in the cooling unit of a Nordic dairy, which included both screw and piston compressors with a cooling capacity of 3200 kW, resulted in energy savings of about 1200000 kWh/yr.

Applicability

Widely applicable in new installations. The lack of space can be an obstacle for existing installations. The technique is economically feasible in installations with deep freeze storage, as normal cold storage does not produce sufficient quantities of heat during winter time.

Economics

Reduced energy costs. The investment cost in the Nordic dairy example above was about EUR 160000 with a payback period of 6.3 years.

Example plants

A dairy in a Nordic Country.

Reference literature

[42, Nordic Council of Ministers, et al., 2001]

4.2.13.6 Switch off equipment when it is not needed

Description

Many simple, no cost and low cost energy saving measures are those that individual employees can take, for example switching off equipment, such as compressors and lighting. Pumps and fans that circulate cold air, chilled water, or an antifreeze solution generate heat, contributing most of the power they consume to the cooling load, so switching them off when not required saves energy. This is also true for lights in a coldstore or cooled room, as they contribute most of the power they consume to the cooling load.

The switching can be timed according to a fixed programme or schedule. Conditions can be monitored to detect, e.g. high or low temperatures, and switch off motors when they are not needed. The load of a motor can be sensed, so that the motor is switched off when idling.

Achieved environmental benefits

Reduced energy consumption.

Applicability

Widely applicable in the FDM sector.

Economics

Reduced energy costs.

Driving force for implementation

Reduced energy costs.

Reference literature

[69, Environment Agency of England and Wales, 2001]

4.2.13.7 Reduce the loads on motors

Description

Motors and drives are used to operate many mechanical systems in industrial processes. The load on motors and drives can be reduced by ensuring that regular servicing and basic maintenance steps such as lubrication of machinery are undertaken.

If the following points are ticked, the loads on motors can be minimised:

- is the machine that the motor is driving efficient?
- is the system doing a useful and necessary job?
- is the transmission between motor and driven equipment efficient?
- are the maintenance programmes adequate?
- have losses due to, e.g. the pipework, ducting and insulation been minimised?
- is the control system effective?

Achieved environmental benefits

Reduced energy consumption.

Applicability

Applicable where motors are used.

Economics

Reduced energy costs.

Driving force for implementation

Reduced energy costs.

Reference literature

[69, Environment Agency of England and Wales, 2001]

4.2.13.8 Minimise motor lossesDescription

Motor losses can be minimised by:

- specifying higher efficiency motors where feasible
- when a motor fails, ensuring that proper care and attention is given in the repair process so as to minimise energy losses
- avoiding the use of greatly oversized motors
- considering permanent reconnection of the motor electrical supply in star-phase, as a no cost way of reducing losses from lightly loaded motors
- checking that voltage imbalance, low or high supply voltages, harmonic distortion or a poor power factor is not causing excessive losses.

Achieved environmental benefits

Reduced energy consumption.

Applicability

Applicable where motors are used.

Economics

Reduced energy costs.

Driving force for implementation

Reduced energy costs.

Reference literature

[69, Environment Agency of England and Wales, 2001]

4.2.13.9 Frequency converters on motorsDescription

Controlling the speed of the pump motor by frequency converters ensures that the speed of the impeller is exactly adapted to the required output of the pump, as are the power consumption and treatment of the liquid.

Achieved environmental benefits

Reduced energy consumption.

Operational data

The reduction of the power consumption depends on the capacity and number of pumps and motors. Generally, a 10 % reduction in the output of a pump corresponds to a 28 % reduction in the power consumption of the pump.

In an example German instant coffee manufacturer, the consistent implementation of frequency converters for all large electrical motors, allowed them to be adjusted in a way that suited the output and electricity peaks during start-up processes were avoided.

In a Danish dairy, 203 motors were equipped with frequency converters. The total power of the motors was 1216 kW. The estimated cost of the investment was EUR 311000. The estimated annual saving is EUR 90000 (1325000 kWh).

A whey products company processes whey into several raw materials for use in pharmaceuticals and foods. One of the products is lactose, the production of which involves a refining process, in which “wet” lactose (9 % pure) is dissolved in hot water in a circular process. Wet lactose is transported through a shaking tray to a mixing vessel, where it is mixed with hot water. The mixture is pumped into a buffer vessel, where it is stirred, and from which it is returned to the mixing vessel. Thus, the lactose content of the mixture gradually increases. After approximately 1 hour, the mixture is discharged from the mixing unit for further processing. The liquid level in the mixing vessel used to be controlled by regulating the water/lactose flow from the buffer tanks. This was achieved by a choke valve on the delivery side of the centrifugal pump used for the transport. This choke system had several disadvantages, e.g. it was inefficient causing unnecessary dissipation of electric energy and it caused unnecessary wear of the pump. The system was replaced with a speed control system on the motor driving the pump. This resulted in energy savings amounting to 12600 kWh/yr, with a value of NLG 1638 (1994), a reduction in maintenance costs of NLG 10257/yr (1994) and a payback period of 0.3 years.

In an example brewery, compressed air (6 bar) is produced by six screw-type and seven piston compressors. One screw type compressor is run as a frequency controlled machine and all compressors are centrally controlled. The advantage of this technology is that the pressure in the supply system does not fluctuate by more than +/- 0.05 bar. The system pressure can be reduced by 0.2 bar. It is reported that an electricity saving of approximately 20 % can be achieved by avoiding compressor idle time. Maintenance costs can be reduced by about 15 %. It is not possible to quantify the cost benefit resulting from the reduction in system pressure.

Applicability

Frequency converters can be used with standard three-phase motors. They are available for both manual and automatic speed controls. They can be applied in existing and new installations for pumps, ventilation equipment and conveying systems. It is reported that frequency converter driven motors should not exceed 60 % of the total energy use of the installation because they can have an adverse effect on the electricity supply and can lead to technical problems.

Economics

The price of a 5.5 kW frequency converter is about EUR 600.

Driving force for implementation

Reduced consumption of electrical power in combination with a more gentle treatment of the product.

Example plants

A dairy in Denmark, a whey manufacturer in the Netherlands, an instant coffee manufacturer in Germany and a brewery in Germany.

Reference literature

[42, Nordic Council of Ministers, et al., 2001, 65, Germany, 2002, 237, Caddet, 1999, 247, Verband der Deutschen Milchwirtschaft (German Dairy Association), 2003]

4.2.13.10 Use variable speed drives to reduce the load on fans and pumps

Description

Motive power in particular can make a significant contribution to energy consumption in industrial processes. The capital cost of a higher efficiency motor is no more than a standard quality motor but the efficiency gain of 2 – 3 % makes significant savings over the motor’s life. In addition, the use of variable speed drives to reduce the load on fans and pumps is a much more energy efficient method of regulating flow than throttles, dampers or recirculation systems.

Achieved environmental benefits

Reduced energy consumption.

Applicability

Applicable to all FDM installations where fans and pumps are used.

Economics

Reduced energy costs.

Driving force for implementation

Reduced energy costs.

Reference literature

[69, Environment Agency of England and Wales, 2001]

4.2.14 Water use**4.2.14.1 Only pump up water that is required**Description

By only pumping up the quantities of water that are actually required in the production process, the impact on groundwater levels is minimised and energy is saved. Water can be extracted on demand to avoid excessive storage and the risk of water being wasted, either through contamination or leakage.

Achieved environmental benefits

Reduced water and energy consumption.

Applicability

Applicable in areas where groundwater is extracted.

Driving force for implementation

Local shortages of groundwater.

Example plants

Fruit and vegetable installations in Belgium.

Reference literature

[31, VITO, et al., 2001]

4.2.15 Refrigeration and air conditioning

(For related techniques under freezing, see Section 4.2.11)

4.2.15.1 Optimising air conditioning and cold storage temperaturesDescription

Not cooling air conditioned rooms and coldstores to a temperature below that necessary reduces energy consumption without compromising food quality. Coldstores are often held at lower temperatures than necessary because of worries about failure. Having a coldstore at a lower temperature than necessary makes it more likely that failure will occur.

It is reported that keeping controls simple and getting settings right can be a big step towards making a refrigeration plant operate as efficiently as possible by, e.g. setting the thermostat to achieve the best energy efficiency for the installation without compromising reliability. Marking the normal readings on gauges helps the early detection of equipment malfunction. Automatic controls can be used to switch off the refrigeration plant and/or lights when they are not required. Lights and motors in cooled spaces not only use electricity, but because they generate heat they contribute to the energy required to decrease the temperature to that required. If they can be removed where unnecessary and switched off when not required, energy can be saved.

Achieved environmental benefits

Reduced energy consumption.

Applicability

Applicable in all FDM installations which have air conditioned spaces and refrigeration equipment.

Driving force for implementation

Reduced energy costs.

Reference literature

[69, Environment Agency of England and Wales, 2001, 241, ETSU, 2000]

4.2.15.2 Minimising transmission and ventilation losses from cooled rooms, coldstores and freezing tunnels

Description

To reduce transmission and ventilation losses in the freezer unit, the following measures can be undertaken:

- keep doors and windows closed as much as possible
- fit fast-closing and effectively insulating doors between areas with different temperatures
- limit door size to the minimum necessary for safe access
- maintain good sealing around doorways. Build-up of ice around openings indicates poor sealing
- do not load materials in the doorway
- cool the area in front of the cooling room
- if a door has to be used regularly, fit a strip curtain
- restrict ventilation by fitting the passage between the loading/unloading space of the vehicle and the storage area with an effective seal
- limit air movements when doors and hatches are opened
- apply adequate thermal insulation and screening of freezing tunnels from their surroundings
- refrigerate at night, when the ambient temperature is lowest.

Achieved environmental benefits

Reduced energy consumption. In some cases, there may also be reduced odour and noise emissions.

Applicability

Applied in the deep freezing of packaged and unpackaged food products and air conditioned rooms.

Economics

In 2001, it was reported that an open door cost GBP 6/h for a freezer store and GBP 3/h for a chill store.

Reference literature

[31, VITO, et al., 2001, 32, Van Bael J., 1998, 69, Environment Agency of England and Wales, 2001]

4.2.15.3 Regularly defrosting the entire system

Description

Evaporators that operate below 0 °C should be completely defrosted before ice starts to cover the fins. This may be every few hours or every few days. When the evaporator is iced-up, the evaporating temperature drops, increasing energy consumption. The capacity also drops and the required temperature may not be reached. If the defrost elements are not working properly, then the frost build-up on the evaporator will worsen. For this reason, it is also important to check that the evaporators defrost properly. Section 4.2.15.5 describes the automatic defrosting of cooling evaporators.

Achieved environmental benefits

Reduced energy consumption.

Operational data

A 1 °C drop in the evaporating temperature can increase the running costs by 2 – 4 %. A defrost-on-demand system, which initiates a defrost when needed rather than by a timer, has reportedly reduced power consumption by 30 % in some applications.

Applicability

Applied in the deep freezing and refrigeration of packaged and unpackaged food products.

Reference literature

[31, VITO, et al., 2001, 32, Van Bael J., 1998]

4.2.15.4 Optimisation of the defrosting cycle

Description

To optimise the defrosting cycle of the evaporators, the time between defrosting cycles can be adjusted. If the time between two defrosting cycles is too long, then the efficiency of the evaporator falls and the pressure drops via the evaporator. If the time is too short, then considerable heat is generated unnecessarily in the storage area.

Achieved environmental benefits

Reduced energy consumption.

Applicability

Applied in the deep freezing of packaged and unpackaged food products.

Reference literature

[31, VITO, et al., 2001, 32, Van Bael J., 1998]

4.2.15.5 Automatic defrosting of cooling evaporators in cold storage

Description

The layer of frost formed on the surface of evaporators reduces their heat-exchange efficiency. Warm gas from compressors can be used for defrosting and to remove this layer. Energy savings depend on the capacity/number of the evaporators and the operating time of the frosted evaporators.

Achieved environmental benefits

Reduced energy consumption.

Operational data

In an ice-cream installation, five evaporators running for 3000 hours per year with an ice layer of 0.87 mm were equipped with an automatic defrosting system. As a result, approximately 100000 kWh/yr energy could be saved. The estimated investment cost was EUR 15000, with a payback of 2.2 years.

Applicability

Widely used in new installations and can easily be applied to existing operations.

Economics

Reduced energy costs. Short payback periods.

Example plants

An ice-cream installation in a Nordic Country.

Reference literature

[42, Nordic Council of Ministers, et al., 2001]

4.2.15.6 Use of binary ice as a cooling fluid (secondary refrigerant)

Description

Binary ice can be used as a refrigerant fluid. Binary ice may be described as “liquid ice”. It comprises ice crystals of 10 – 100 µm, in suspension in water, containing antifreeze. The antifreeze is either ethanol-based containing an anti-corrosion substance, or if the binary ice is for the immersion of food, common salt (sodium chloride).

Two technologies are described for the production of binary ice. The first, which is shown in Figure 4.20, is for small and medium capacity binary ice, i.e. 100 – 1000 kW. The numbers in the following text refer to Figure 4.20. The binary ice is generated with a special evaporator, called a binary ice generator (1), which is supplied with fluid by a pump (2), from a binary ice storage vessel (3). A conventional refrigeration plant (4), with a small refrigerant charge, is connected to the binary ice generator. “Natural” refrigerants such as water (not for freezing), air, carbon dioxide (still under development), ammonia and hydrocarbons can be used, as alternatives to chlorofluorohydrocarbons. A secondary pump (5) supplies binary ice at a given ice concentration into the main feed pipe (6), where pumps (7) (optional), supply binary ice to the cooling loads (8). In the case of “zero load”, but on standby, the binary ice is kept circulating in the secondary loop (6) and (10) but is passed over valve (9), which opens as soon as the cooling loads are disengaged. The return pipe (10) transports the binary ice fluid, (with or without ice crystals) back to the storage vessel (3).

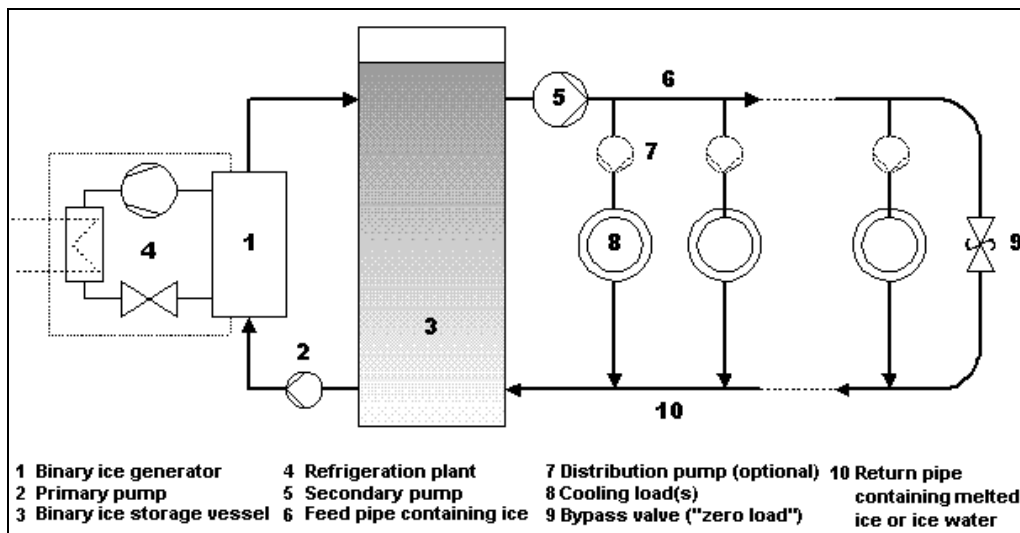

Figure 4.20: Binary ice system with a conventional refrigeration plant

Medium and large capacities of binary ice, i.e. 1000 kW – 1 MW, can also be produced with a refrigeration process with “water as refrigerant”. The technology is very similar to that shown in Figure 4.20, with the exception that the conventional refrigeration plant (4) is not necessary. A water vapour compressor and suitable vacuum conditions, for binary ice typically 500 Pa (5 mbar), cause the water to evaporate in an empty vessel (evaporator) and the compressor removes the water vapour, which is eventually condensed.

Achieved environmental benefits

Under comparable conditions, the coefficient of performance for binary ice is normally better than for conventional chilling and freezing plants, i.e. less power is consumed. Smaller refrigeration units are required, so fewer materials are needed and reportedly, because they do not have to be so chemically resistant, they can be simpler and better suited for recycling. As the entire installation is not filled with potentially harmful refrigerants, the probability and severity of an accidental release is reduced. Unlike other refrigerants, binary ice made from water and alcohol can normally be released to the WWTP, with the permission of the regulator. The properties of an ice crystal's rapid phase change reportedly ensure excellent heat transfer. The surface can, therefore, either be reduced or the binary ice can be "warmer", which results in lower energy demand and less surface freezing. The product weight loss is consequently less and defrost may even be unnecessary for air chillers. Fluid coolers can reportedly also be 20 to 50 % smaller.

Operational data

Table 4.6 compares the volumes of the refrigerants brine and binary ice required to achieve a 3 °C decrease in temperature.

Cooling process	Refrigerant	Comparable cooling ability for a given mass, to achieve a 3 °C decrease in temperature	Energy available for cooling (kJ/kg)
Chilling	Brine	1	11
	Binary ice of 10 % ice crystals	3.0	33
	Binary ice of 20 % ice crystals	6.0	66
Freezing	Brine	1	11
	Binary ice of 10 % ice crystals	3.7	33
	Binary ice of 20 % ice crystals	7.3	66

Table 4.22: Comparison between the volumes of binary ice and brine required to achieve a 3 °C decrease in temperature

For example, four to seven times more refrigerant has to be circulated if brine is used as a refrigerant, compared to binary ice. It has been reported that pipe diameters can be approximately 50 % smaller and the pumping power 70 % lower, for binary ice compared to brine. It is also reported that binary ice plants commonly run throughout 24 h/d, so only a small ice making machine and storage volume is required.

In an example slaughterhouse and meat processing installation, the slaughtered cattle and pig carcasses were chilled, prior to further processing. The following binary ice plant, with a total installed capacity of 424 kW, was installed and provides the cooling requirements shown in Table 4.23.

Total area used	3800 m ²
Number of employees	40
Production per week	500 cattle and 2000 pigs
Refrigerant	Ammonia
Binary ice system	Trade name
Number of independent refrigeration plants	2
Compressors	Gram (reciprocating)
Additional features	Heat recovery
Cooling work per day	5500 kWh/d
Full load operating hours (maximum)	13 h/d
Installed refrigerating capacity (icemakers)	230 kW
Operating hours of the binary ice plant (hottest summer day)	24 h/d
Binary ice storage work	1600 kWh
Binary ice storage volume	34 m ³
Binary ice fluid corrosion inhibitor	Trade name
Maximum binary ice concentration in ice storage	>50 %
Binary ice concentration in the pipework	12 %

Table 4.23: Cooling requirements of a binary ice plant

Applicability

Applicable to all FDM installations.

Economics

For the slaughterhouse and meat processing example referred to above, the service life was 15 years. With an interest rate of 7 % and a depreciation time of 10 years, the additional direct investment costs could reportedly be recovered in 2.2 years and the annual operating costs of the binary ice plant, including depreciation, immediately recoverable. It is estimated that the payback time would be 10 to 15 years for typical Danish slaughterhouses.

It is reported that binary ice plants normally run at off-peak tariff or during times when there is a low overall electrical loading.

Driving force for implementation

The phase-out of ozone depleting chlorofluorocarbons under the “Montreal protocol” and the expected pressure to reduce the use of hydrochlorofluorocarbons by the “Kyoto protocol”.

Example plants

Applied in meat processing, fish processing, brewing and cold storage in Germany.

Reference literature

[182, Germany, 2003]

4.2.16 Compressed air generation and use

4.2.16.1 Optimise pressure settings

Description

The pressure at the compressor can be set at the maximum required and then regulated at each individual application to minimise the energy required to produce compressed air and reduce leakage. For applications which require higher pressures or have longer operating hours than the majority of the applications which use compressed air, it may be more energy and cost effective to install a dedicated compressor.

Achieved environmental benefits

Reduced energy consumption and reduced noise, if large compressors run for shorter periods.

Applicability

Applicable where there is more than one use for compressed air in an installation.

Driving force for implementation

Reduced energy consumption and associated costs.

Example plants

Widely applied.

Reference literature

[69, Environment Agency of England and Wales, 2001]

4.2.16.2 Optimise the air inlet temperatureDescription

Compressors operate more efficiently using cool air. This is generally achieved by ensuring the air is taken from outside the building. This can be checked by measuring the drier inlet temperature, which should not exceed 35 °C with the compressors on full load. The temperature of the drier room should be within 5 °C of the outside ambient temperature. If the room temperature is too high, this lowers the compressor's performance.

Achieved environmental benefits

Reduced energy consumption.

Driving force for implementation

Reduced energy consumption and associated costs.

Reference literature

[69, Environment Agency of England and Wales, 2001]

4.2.16.3 Fit silencers to air inlets and exhaustsDescription

Fit silencers to the compressor air inlet or exhaust. Silencers can be absorptive or reactive. Absorptive silencers absorb the noise. Reactive silencers contain chambers and baffles and their size and position determine the silencer's sound attenuation characteristics. Reactive silencers may be more effective for compressors, which generate significant levels of low frequency tonal noise.

Achieved environmental benefits

Reduced noise emissions.

Cross-media effects

If the silencer is not well designed, there may increased energy consumption, due to back pressure or blockage.

Operational data

It is reported that a well designed silencer will not increase system back pressure. If the silencer is not well designed, increased attenuation may increase pressure loss and consequently increase energy consumption. Back pressure can be minimised by increasing the size of the silencer and the coupling between the silencer and the compressor. Fitting a straight-through silencer can prevent both back pressure and blocking.

It is reported that multiple exhausts can be attached to a manifold leading to a single, larger diameter pipe. It is reported that the rear silencer from virtually any make of car can be used to achieve a typical reduction of 25 dB(A).

Applicability

Applicable where compressed air is used.

Economics

Low cost.

Driving force for implementation

Prevention of occupational noise induced hearing loss and reduced complaints about noise emissions from outside the installation.

Example plants

Widely applied.

Reference literature

[65, Germany, 2002, 200, CIAA, 2003, 242, Lewis D. N., 2003, 244, Health and Safety Executive,]

4.2.17 Steam systems

4.2.17.1 Maximise condensate return

Description

If hot condensate is not returned to the boiler it has to be replaced by treated cold make-up water. The additional make-up water also adds to water treatment costs. Instead of routinely discharging condensate to the WWTP because of the risk of contamination, the condensate can be collected in an intermediate tank and analysed to detect the presence of any contaminant. This also leads to savings in the use of chemicals for the treatment of boiler feed-water. Additionally or alternatively, if the condensate cannot be returned to the boiler due to contamination, heat can be recovered from the contaminated condensate before it is used for lower grade cleaning activities, e.g. yard cleaning.

The energy in any steam used for direct injection to the process may be considered to be fully utilised.

Achieved environmental benefits

Reduced energy and water consumption and reduced waste water generation. Reduced consumption of boiler feed-water treatment chemicals.

Operational data

If hot condensate is not returned to the boiler, it has to be replaced by treated cold make-up water and wastes some 20 % of the energy absorbed in the generation of the steam from which the condensate is derived. This may be the greatest single energy loss in steam use.

Applicability

Applicable where steam is produced in a boiler.

Driving force for implementation

Reduced energy consumption and associated costs.

Reference literature

[69, Environment Agency of England and Wales, 2001]

4.2.17.2 Avoid losses of flash steam from condensate return

Description

When condensate is discharged from steam traps and flows along the return pipework, some flash steam is formed. Often flash steam is vented to the air and the energy it contains is lost. It may be possible to capture and use the flash steam, e.g. in the boiler.

Achieved environmental benefits

Reduced energy and water consumption.

Operational data

The flash steam typically contains about 40 % of the energy in the original pressurised condensate.

Applicability

Applicable where flash steam is produced and can be re-used.

Driving force for implementation

Reduced energy consumption and associated costs.

Reference literature

[69, Environment Agency of England and Wales, 2001]

4.2.17.3 Isolate unused/infrequently used pipeworkDescription

There may be branches of the steam distribution system that are no longer used and can be removed from the system. Also, pipework that supplies steam to infrequently used equipment can be isolated using valves or slip-plates. Unused and infrequently used pipework causes energy to be consumed unnecessarily and is likely to receive less maintenance attention. Removal of pipework may leave the remaining pipework inadequately supported, so additional support may be required.

Achieved environmental benefits

Reduced energy and water consumption.

Applicability

Fully applicable.

Driving force for implementation

Reduced energy consumption and associated costs.

Reference literature

[69, Environment Agency of England and Wales, 2001]

4.2.17.4 Minimising the blowdown of a boilerDescription

The blowdown of a boiler is used to limit the accumulation of salts, e.g. chlorides; alkalis and silicic acid, and is, therefore, necessary to keep these parameters within prescribed limits. It is also used to remove the sludge deposits, e.g. calcium phosphates, and corrosion products, e.g. ferric oxides from the boiler and to keep the water clear and colourless. Waste water at high pressure and temperature is always discharged, either for a set time or continuously. It is, therefore, preferable to restrict the blowdown as far as possible.

The total dissolved solids content of the boiler water is best kept as close as possible to the maximum authorised value. This can be done via an automated system consisting of a conductance probe in the boiler water, a blowdown regulator or a blowdown regulating valve. The conductance is continually measured. If the measured conductance exceeds the maximum value, then the regulating valve is opened more.

To reduce energy consumption, heat can be recovered from the blowdown of a boiler.

Achieved environmental benefits

Reduced energy consumption. Reduced waste water generation.

Operational data

Table 4.24 shows the potential fuel savings by reducing the blowdown as a function of steam pressure in the deep freezing of vegetables. At a steam pressure of 10 bar, a fuel saving of 2.1 % can be achieved if the blowdown volume is reduced by 10 %.

Effective boiler pressure (bar)	Fuel saving per blowdown reduction (%)
7	0.19
10	0.21
17	0.25

Table 4.24: Potential savings by reducing boiler blowdown in the deep freezing of vegetables

Applicability

Applicable where a boiler is used.

Reference literature

[31, VITO, et al., 2001, 32, Van Bael J., 1998]

4.3 Cleaning

Processing equipment and production facilities are cleaned and disinfected periodically, with the frequency varying according to the products and processes. The aim of cleaning and disinfection is to remove product remnants from the foregoing process run, other contaminants and micro-organisms in order to guarantee product quality, food safety, line capacity, heat transfer and optimum operation of the equipment. It can be carried out manually, e.g. using pressure cleaning or automatically, e.g. using CIP. Manual cleaning generally requires the dismantling of the equipment to be cleaned.

4.3.1 Dry cleaning of equipment and installations

See also some sector-specific examples in Sections 4.7.1.2, 4.7.2.2, 4.7.5.2 and 4.7.9.2.

Description

As much residual material as possible can be removed from vessels, equipment and installations, before they are wet cleaned. This can be applied both during and at the end of the working period. All spillages can be cleaned up, by, e.g. shovelling or vacuuming spilt material or by using a squeegee, prior to wet cleaning, rather than hosing them down the drain. This reduces the entrainment of material into water, which would consequently have to be treated in either an on-site or municipal WWTP. This is enhanced further by transporting materials such as ingredients, by-products and waste from processing as dry as possible (see Section 4.1.7.4).

Dry cleaning is facilitated by, e.g. providing and using catchpots (see Section 4.3.1.1) with a mesh cover, making sure suitable, dry clean-up equipment is always readily available and providing convenient, secure receptacles for the collected waste. Catchpots may be locked in place to ensure that they are in place during cleaning.

As well as manual dry cleaning of equipment and installations, other measures can be used, such as letting materials drain naturally, by gravity, into suitably located receptacles and by using pigging (see Section 4.3.3)

The cleaning procedure can be managed to ensure that wet cleaning is minimised and that the necessary hygiene standards are maintained. For example, the use of hoses can be prohibited until after dry clean-up.

Achieved environmental benefits

Reduced water consumption and volume of waste water. Reduced entrainment of materials in waste water and, therefore, reduced levels of, e.g. COD and BOD. Increased potential for the recovery and recycling of substances generated in the process. Reduced use of energy needed to heat water for cleaning. Reduced use of detergents.

Cross-media effects

Increased solid waste.

Operational data

It is common practice for the staff involved in cleaning to remove floor drain grates and hose raw materials and product directly down the drain, perhaps believing that a subsequent screen or catchpot will trap all solids. However, when these materials enter the waste water stream they are subjected to turbulence, pumping and mechanical screening. This results in the breakdown and release of soluble BOD, along with colloidal and possibly suspended grease solids. Subsequent removal of this soluble, colloidal and suspended organic matter can be far more complicated and expensive than the use of simple catchpots with mesh covers.

For example, in sausage making, ground meat residues from equipment such as bowl choppers, sausage fillers and from floors can be manually removed, to the maximum practical extent prior to cleaning and sent, e.g. to a rendering installation, instead of being washed into the WWTP.

In an example fish processing installation, dry cleaning of belts was undertaken and this resulted in less waste being produced and it practically eliminated water pollution.

In fruit and vegetable processing, product losses throughout the process, can be shovelled up and sent for use as animal feed.

Grain dust can be collected by vacuum systems in, e.g. flour mills, animal feed mills, breweries and distilleries.

When cleaning dusty materials, it is important to consider the risks associated with fire and explosion and with occupational health.

When cleaning equipment, it is important to consider the risks associated with access to hazardous moving parts and to sharp edges.

Immediate removal may be necessary to safeguard hygiene and prevent microbiological risks.

Applicability

Applicable to all FDM installations.

Driving force for implementation

Reduced energy and water use, reduced need for waste water treatment and lower detergent use and expenditure.

Example plants

Many installations apply some dry cleaning prior to wet cleaning.

Reference literature

[1, CIAA, 2002, 13, Environment Agency of England and Wales, 2000, 31, VITO, et al., 2001, 41, Nordic Council of Ministers, 2001, 134, AWARENET, 2002]

4.3.1.1 Provision and use of catchpots over floor drains

Description

A catchpot is a fine mesh basket placed over floor drains, to prevent solids from entering the drainage system and the WWTP. Catchpots can be locked in place to ensure that solids are not able to enter the WWTP during cleaning. If they are emptied after dry cleaning and locked in place again before wet cleaning, then entrainment of soluble materials and of particles broken off the solids by the cleaning water can be avoided.

Achieved environmental benefits

Solids which are not prevented from falling on the floor by other means do not enter the waste water. This reduces the SS, BOD, COD, FOG, total nitrogen and total phosphorus in the waste water. The solids collected in the catchpot can be sent for appropriate non-food uses or disposal treatment.

Cross-media effects

Increased solid waste.

Operational data

The mesh size may vary depending on the application and the frequency of emptying may also vary depending on the characteristics of the potentially spilled materials.

The use of catchpots in meat processing installations, combined with dry cleaning can minimise the entrainment of meat scraps in the waste water as well as the entrainment of FOG caused by the contact between cleaning water and scraps of meat and fat.

Applicability

Applicable to all FDM installations.

Economics

Very cheap to operate.

Driving force for implementation

Reduced contamination of waste water and consequently easier waste water treatment.

Example plants

Widely applied in the FDM sector.

Reference literature

[134, AWARENET, 2002, 200, CIAA, 2003]

4.3.2 Pre-soak floors and open equipment to loosen dirt before cleaning

Description

Floors and open equipment can be pre-soaked before being wet cleaned. This can loosen the dirt and, therefore, make subsequent cleaning easier, e.g. less water, at high pressure and/or high temperature, may be required to dislodge hardened or burnt-on dirt and the use of chemical cleaning substances, such as caustic, may be minimised.

Achieved environmental benefits

Depending on the circumstances, the consumption of water and energy for heating water may be reduced. The consumption of chemicals may be reduced.

Applicability

Applicable where hardened or burnt-on dirt needs to be removed during cleaning.

Reference literature

[1, CIAA, 2002]

4.3.3 Pigging

Description

Pigging can be used to recover valuable products from pipelines and to reduce water and waste water costs.

The system comprises launchers, catchers, compressed air equipment and in-line valves to allow the pig to pass through the system. One-piece, food grade rubber “pigs”, are propelled along from a launcher using compressed air and stopped at the other end of the pipe by a bar that allows product, but not the pig, to pass. The pig is returned to the launcher by using a valve to switch the direction of the compressed air. A window at either end of the pipe allows the pig to be seen by the operator. The pig is used between each batch, with additional system rinses being carried out when colour or flavour cross-contamination can occur. Occasional CIP cleans, e.g. using caustic, are used for hygiene reasons.

Achieved environmental benefits and economics

Reduced product losses during batch change-overs and cleaning; reduced water consumption for cleaning and a lower quantity of waste water that is also less contaminated.

Operational data

An example jam manufacturer installed a new pigging system, as described above. Installation and operator training were carried out on site with assistance from the supplier. Regular checks made in the company's laboratory show that the new system did not compromise hygiene standards or affect product quality.

The example company normally makes jam for bulk sale in 2.5 tonne batches. The cooked jam is held in two high temperature kettles, before being pumped to holding tanks next to the loading bay, where the batch can be kept warm. Then it is pumped into a bulk tanker, or cooled for transfer into intermediate bulk containers.

In addition to cleaning for hygiene reasons, the pipes and vessels are cleaned between batches when colours change. For the bulk production process, the cleaning sequence was a water rinse of the whole system, CIP vessel clean, sometimes with caustic and a final water rinse of the whole system.

Before the pigging system was introduced, the whole system rinse involved sucking cleaning water, under vacuum, through the pipes between the pulping and evaporator vessels and the kettles, and then using the jam pump to pump the cleaning water through the pipe run to the tanker bay. As the jam pump was not designed to pump water, each flushing took some time. A large amount of water (5.4 m³/clean) was also used, typically twice a day. Saleable product left in the pipe was pushed out by the flush waters to drain. The site waste water thus had high SS and COD levels.

Jam used to be wasted between batches on the bulk line. Following installation of the pigging system, there was an increased batch yield of jam. This resulted in some 173 tonnes of saleable product being recovered annually. The amount of mains water used to flush the bulk pipeline fell from 2020 m³/yr to 310 m³/yr. Waste water volumes from the bulk line decreased by the same amount.

The reduction in average COD levels for the site waste water fell from around a peak of 25000 mg/l to around 5000 mg/l, meaning that unit costs fell by over 76 %, from EUR 12/m³ to EUR 2.83/m³. Further economic information is given in Table 4.25.

Although pigging is the most significant reason for the reduction in COD levels, the example company believes that there is also a significant contribution from the vacuum cleaning of sumps, gulleys and food traps. The pigging system required virtually no maintenance during the first year and no new pigs were needed. Due to wear and tear of the pigs, the company expect to replace a maximum of two each year. Energy consumption fell by around 680 kWh/yr because the compressed air mechanism required less energy than the old pumping arrangements.

The company recently installed three further pigging systems on other non-bulk manufacturing lines. Substantial cost savings are expected, together with a further reduction in waste water COD levels.

Line cleaning takes slightly less time with the pigging system than with the old system.

Applicability

Applicable where viscous materials are transferred by pipeline, e.g. during the production of sweet and savoury preserves and the manufacturing of dairy products such as yoghurt.

Economics

The annual costs and savings associated with the use of pigging in the example jam making installation are shown in Table 4.25.

Item	Savings	Annual savings (EUR)		Annual costs (EUR)
Reduced waste water COD and volume	76 %	167000		
Recovered product	173 t/yr	217000		
Reduced water use	2020 m ³ /yr	2000		
Reduced energy consumption		48		
Gulley cleaning, etc.				6200
Replacement pigs (2/yr)				180
Total		386048		6380
Net cost savings			379668	
Total capital cost			30800	
Payback period			4.2 weeks	

Table 4.25: Environmental benefits and associated cost reduction using pigging systems

Driving forces for implementation

Recovery of valuable product and reduced water and waste water treatment costs.

Example plant

At least one jam making installation in the UK.

Reference literature

[1, CIAA, 2002, 57, Envirowise (UK), 2000]

4.3.4 Removal of residual materials from pipework, using compressed air, before cleaning or product change-over

Description

Food quality compressed air can be used as a dry cleaning technique to remove residual materials from pipework, taking care not to raise dust levels in the workplace. Some advantages of the technique include that it can be used to gain access to parts of equipment where pigs (see Section 4.3.3) cannot physically pass and any risk of contamination from introducing cleaning tools or equipment can be avoided.

Achieved environmental benefits

Reduced product losses during batch change-overs and cleaning; reduced water consumption for cleaning and a lower quantity of waste water that is also less contaminated.

Cross-media effects

Energy is consumed to produce compressed air.

Operational data

To minimise the amount of residual butter in the pipework of butter-making equipment, compressed air can be used to push a block of cooled butter through the pipework and valves at the end of production, before the cleaning. This works in a very similar way to pigging, but is possible in parts of the equipment inaccessible to pigs.

Applicability

Applicable in installations where powders and other solids are transported using compressed air and where hard, but compressible foods can fill a space and physically force materials through that space.

Driving force for implementation

Minimisation of product waste.

Example plants

Butter-making dairies in Germany.

Reference literature
[65, Germany, 2002]

4.3.5 Management of water, energy and detergents used

Description

If the consumption of water and detergents, and the cleanliness is recorded on a daily basis, it is possible to detect deviations from normal operation and then to monitor and plan ongoing efforts to reduce the future consumption of both water and detergents without jeopardising hygiene. This applies to all cleaning, whether it is manual, e.g. using pressure cleaning, or automated, e.g. using CIP.

Trials can also be undertaken, e.g. using less or no detergents; using water at different temperatures; using mechanical treatment, i.e. the use of “force” both in the water pressure, and from using tools such as scouring sponges and brushes.

Monitoring and controlling the cleaning temperatures can enable the required cleaning standard of equipment and installations to be achieved without the excessive use of cleaning agents.

An important part of preventing the overuse of water and detergents on an ongoing basis is ensuring that staff are trained in the handling, and making up of solutions and their application. For example, they should not make cleaning solution concentrations too high, either by pouring too much during manual dosing or by setting automatic dosing systems too high. This can happen easily, through lack of training and supervision, particularly during manual dosing.

Achieved environmental benefits

Potential reduced consumption of water and detergent and of the energy required to heat the water. The reduction potential depends on the cleaning requirements at each part of the installation or equipment to be cleaned.

Operational data

Inadequate hygiene controls cause food safety problems, which can result in product rejection or a shortened shelf-life. Improvements in cleaning techniques can be achieved by, e.g. using flow restrictions on the water supply and regulating the water pressure from high pressure to medium and low pressure for night and day cleaning, respectively. The frequency of wet cleaning can also be assessed with the objective of reducing the number of full wet cleans. In some installations, one full wet clean per day may be sufficient to maintain the required hygiene level.

The planning of equipment cleaning frequency and duration can take into account its size and complexity and the type and degree of soiling.

Applicability

Applicable to all FDM installations.

Economics

The technique can result in reduced water, energy and detergent costs.

Driving force for implementation

Reduced water, energy and detergent costs.

Reference literature

[1, CIAA, 2002, 13, Environment Agency of England and Wales, 2000]

4.3.6 Fit cleaning hoses with hand operated triggers

Description

Trigger control shut-offs can be fitted to cleaning hoses with no other modification, if a water heater is used to provide hot water. If a steam and water blending valve is used to provide hot water, it is necessary to install check valves to prevent steam or water from entering the wrong line. Automatic shut-off valves are often sold with nozzles attached. Nozzles increase the water impact and decrease the water flowrate.

Achieved environmental benefits

Reduced water and energy consumption.

Operational data

In an example installation, the energy saved was calculated for running a hose that had been fitted with an automatic shut-off valve and nozzle, using water at a temperature of 71 °C. The flowrate before installation was 76 l/min and after installation was 57 l/min. The time the hose was running was 8 h/d before installation and 4 h/d afterwards. For a water cost of USD 21/m³, an annual water cost saving of USD 4987 (costs in 2000) was calculated. An annual energy saving of 919 GJ has also been calculated.

Applicability

Applicable to all FDM installations.

Economics

If nozzles are installed without automatic shut-offs, the equipment costs are less than USD 10. An automatic trigger controlled shut-off with a nozzle costs approximately USD 90. (Costs in 2000). The payback is reported to be immediate.

Driving force for implementation

Reduced water and energy costs.

Example plants

Widely applied.

Reference literature

[1, CIAA, 2002, 227, Ockerman H. W. and Hansen C. L., 2000]

4.3.7 Pressure cleaning

Pressure cleaning is used for cleaning floors, walls, vessels, containers, open equipment and conveyors and as a rinsing stage following cleaning and the application of chemicals. Both cold and hot water can be used, depending on the cleaning needs.

4.3.7.1 Supply of pressure-controlled water and via nozzles

Description

Where a supply of water is essential, it can be supplied through nozzles (see Section 4.1.8.8) fitted to the equipment for processing or fitted to hoses used for cleaning equipment and/or installations. For cleaning operations, the water may be supplied to the hoses from a ring main. Nozzles fitted to processing equipment are designed and positioned for each individual cleaning application.

Achieved environmental benefits

Reduced water consumption. Where heated water is used, the overall energy consumption can be reduced.

Operational data

The water flowrate at each nozzle can be set by the management, depending on the application. Also, the water pressure can be adjusted according to the cleaning operation requiring the highest pressure and a suitable pressure regulator can be installed at each of the other cleaning stations which require water. The water consumption can be optimised by monitoring and maintaining the water pressure and the condition of the water spray nozzles.

Applicability

Applicable in all FDM installations, according to in-line, general operational and cleaning needs.

Driving force for implementation

Reduced water consumption.

Reference literature

[1, CIAA, 2002]

4.3.7.2 High pressure cleaning using a centralised water ring main

Description

In high pressure cleaning, water is sprayed at the surface to be cleaned at pressures ranging from 15 bar, which is considered to be low pressure, up to 150 bar, which is considered to be high pressure. A pressure of about 40 to 65 bar has also been described as high.

Mobile pressure cleaning machines require longer downtimes than those supplied from a ring main. Diesel operated pressure cleaners emit fumes, which make them unsuitable for use inside FDM installations. Electrically operated pressure cleaners require additional operator safety precautions, including residual current devices and high maintenance. Mobile machines reportedly also use more water.

Cleaning agents are injected in the water, at moderate temperatures of up to 60 °C. An important part of the cleaning action is due to mechanical effects. Pressure cleaning reduces water and chemical consumption compared with mains hoses. It is important, however, that a pressure that is both safe and efficient is used. There is concern in the food industry about the hygiene implications of over-splash and aerosols associated with the use of high pressure hoses.

High and medium pressure cleaners have the following advantages compared with low pressure cleaners, i.e. water use is lower due to the mechanical cleaning action of the water jet; chemical use is lower because heavy soiling is removed by the action of the water jet and the reduction in water volume means that there is less of a breeding ground for bacteria. However, there can be concerns about the increased aerosol risks with higher water pressures.

Research has shown that even low pressure systems can cause a significant level of aerosol above the height of 1 metre and should not, therefore, be used during production periods in hygiene sensitive areas. Dry clean-as-you-go systems can be used and these not only reduce water consumption and optimise waste disposal, but reduce the risks of slipping accidents. Outside of production periods, both high and low pressure systems can be used safely, but because of its better efficiency, a high pressure system is more cost effective. High pressure cleaning is reported to be fast, easy to use, efficient and cost effective.

Achieved environmental benefits

Reduced water and chemical consumption, compared to traditional hoses and to low pressure high volume pressure cleaning.

Operational data

Ring mains have the advantage that they are always available for use. When using high pressure cleaning, it is important that the correct balance is achieved between the pressure; water volume where the water is sprayed; the water temperature and chemical dosing for each particular application. Inadequate pressure may result in poor cleaning and excessive pressure will increase the risk of damage to surfaces and equipment and even of injury to people.

Applicability

Widely applicable in the FDM sector.

Economics

The cost savings in steam, water and waste water, of high pressure/low volume systems compared with low pressure/high volume systems are reported to be around of 85 %. Reduced costs associated with reduced consumption of chemicals.

Example plants

Widely applied.

Reference literature

[17, Envirowise (UK) and March Consulting Group (UK), 1998]

4.3.7.3 Low pressure foam cleaning

Description

Low pressure foam cleaning can be used instead of traditional manual cleaning with water hoses, brushes and manually dosed detergents. It can be used to clean walls, floors and equipment surfaces. A foam cleaner, such as an alkaline solution, is sprayed on the surface to be cleaned. The foam adheres to the surface. It is left for about 10 – 20 minutes and is then rinsed away with water.

Low pressure foam cleaning can either use a centralised ring main or decentralised individual units. Centralised systems supply pre-mixed cleaning solutions and pressurised water from a central unit and during cleaning they automatically change between foam spreading and rinsing. Mobile pressure cleaning machines require longer downtimes than those supplied from a ring main. Diesel operated pressure cleaners emit fumes, which make them unsuitable for use inside FDM installations. Electrically operated pressure cleaners require additional operator safety precautions, including residual current devices and high maintenance. Mobile machines reportedly also use more water.

Achieved environmental benefits

Reduced water, chemical and energy consumption compared to the use of traditional water hoses, brushes and manually dosed detergents.

Operational data

A new dairy in Denmark, producing 25000 tonnes of cheese per year, has a centralised system consisting of about 50 satellite units, located in the different process areas. The water consumption has been calculated to be 40 % of the corresponding consumption for traditional manual cleaning. The foam cleaning system reportedly uses cold water at 10 °C, whereas manual cleaning with water hoses requires water of at least 40 °C. The calculated savings in this case are 19800 m³ water/yr and 1160 MWh/yr.

Reported advantages of using foams include increased contact time with soiled surfaces, which allows improved cleaning results to be achieved, even though less aggressive chemicals are used. The chemical constituents soften soiling, resulting in improved rinsing efficiency and cleaning. It is easy to see where foams have been applied and they are very easy to rinse, so less water is used. Labour costs are also reduced because, compared with traditional methods, cleaning takes less time. Due to less aggressive chemicals being used, there is reduced wear and tear on machinery and reduced risk to the operator.

A potential disadvantage of using foams is that their bulky nature can cause them to shear from surfaces under their own weight, so reducing the contact time.

Applicability

Applicable in new and existing installations, for cleaning floors, walls, vessels, containers, open equipment and conveyors.

Economics

The investment cost of the foam cleaning system in an example cheese installation in Denmark (reported in 2000) was about EUR 188000, with a payback time of 3.2 years.

Driving force for implementation

Better cleaning and the elimination of problems associated with high pressure cleaning, e.g. spreading of aerosols containing dirt particles and bacteria.

Example plant

At least one cheese installation in Denmark.

Reference literature

[17, Envirowise (UK) and March Consulting Group (UK), 1998, 42, Nordic Council of Ministers, et al., 2001]

4.3.7.4 Cleaning with gels

Description

Gels are typically used for cleaning walls, ceilings, floors, equipment and containers. The chemical is sprayed onto the surface to be cleaned.

Achieved environmental benefits

Reduced water, chemical and energy consumption compared to the use of traditional water hoses, brushes and manually dosed detergents.

Operational data

Cleaning with gels provides a longer contact time than foams, between the soiling and active detergent, because of the tenacious nature of gels with surfaces and there is greater accessibility to crevices as access is not inhibited by air bubbles. However, gels are transparent and difficult to see and may be inconsistent at high temperatures.

Reported advantages of using gels include increased contact time with soiled surfaces, which allows improved cleaning results to be achieved, even though less aggressive chemicals are used. The chemical constituents soften soiling, resulting in improved rinsing efficiency and cleaning. As gels are very easy to rinse, less water is used. Labour costs are also reduced because, compared with traditional methods, cleaning takes less time. Due to less aggressive chemicals being used, there is reduced wear and tear on machinery and reduced risk to the operator.

Applicability

Applicable in new and existing installations, for cleaning floors, walls, vessels, containers, open equipment and conveyors.

Driving force for implementation

Elimination of problems associated with high pressure cleaning, e.g. spreading of aerosols containing dirt particles and bacteria.

Reference literature

[17, Envirowise (UK) and March Consulting Group (UK), 1998]

4.3.8 Selection of cleaning agents

The selection of the cleaning agents is subject to several criteria, including the plant design, cleaning techniques available, type of soiling and nature of the production processes. Cleaning agents must be fit for their use but other aspects are also important, e.g. gluconic acid is less corrosive than the other acids. Furthermore, cleaning in the FDM sector does not just mean the removal of impurities: disinfection is equally important.

The selection and use of cleaning and disinfection agents must ensure effective hygiene control but with due consideration of environmental implications [1, CIAA, 2002]. When the use of cleaning agents is essential, it is necessary to first check that they can achieve an adequate level of hygiene and then to assess their potential environmental impact.

Typical cleaning agents used in the FDM sector are:

- alkalis, e.g. sodium and potassium hydroxide, metasilicate, sodium carbonate
- acids, e.g. nitric acid, phosphoric acid, citric acid, gluconic acid
- pre-prepared cleaning agents containing chelating agents such as EDTA, NTA, phosphates, polyphosphates, phosphonates or surface-active agents
- oxidising and non-oxidising biocides.

4.3.8.1 Selection of disinfectants and sterilants

The chemicals used for disinfection and sterilisation of equipment and installations operate on the principle that they affect the cell structure within bacteria and prevent their replication. Disinfectants used in the FDM sector are within the scope of the Directive 98/8/EC [226, EC, 1998]. Assessment of the environmental and human health effects of active substances in disinfectants is due to start in 2007 [199, Finland, 2003].

Several types of treatment can be applied. These involve the use of oxidising biocides, non-oxidising biocides, UV radiation and steam. Information about the techniques which use oxidising biocides, UV radiation and steam is given in Sections 4.5.4.8, 4.5.4.8.1 and 4.5.4.8.2.

Non-oxidising biocides involve the use of, e.g. quaternary ammonium salts, formaldehyde and glutaraldehyde. These are generally applied using a technique called “fogging” where the substance is sprayed into the area to be sterilised as a mist and allowed to coat the exposed surfaces. This is carried out between process shifts, so the fog has dispersed before the operator enters the work area. Exposure can cause respiratory problems, so occupational health needs to be considered when selecting and using disinfectants and sterilants.

4.3.8.2 Use of chelating agents

In the FDM sector, chelating agents are primarily used in the dairy sector. Acidic, alkaline and surface-active cleansing agents, as well as prepared industrial cleaning agents, generally contain some chelating agents. They are able to dissolve and inactivate metal ions by complex formation. They are used to clear scale deposits and to prevent calcium and magnesium scaling, thus preventing sedimentation and incrustation in pipes, devices or containers.

One of the main applications of alkaline cleansing agents is in the dairy sector. They have various uses, e.g. in CIP; bottle and crate cleaning; foam and/or gel cleaning; membrane cleaning; and manual cleaning. The chemicals used in CIP are normally an alkaline solution, based on caustic, to detach and remove fat and protein layers, and an acid solution, e.g. based on HNO₃, to detach and remove mineral layers.

In many cases in CIP, the acid step is not required and cleaning is undertaken using only the alkali step, i.e. single-phase cleaning. In these cases, if calcifications and deposits are present, it is reported that they can only be removed with the help of a chelating agent such as EDTA. The EDTA dissolves the calcium out of the precipitate and breaks up the structure of the deposits.

Then the remaining organic substances, such as fat and protein layers can be degraded by the alkaline solution, which is usually based on caustic.

The most commonly used chelating agents are:

- ethylenediaminetetraacetic acid (EDTA)
- nitrilotriacetate (NTA)
- methylglycin diacetate (MGDA)
- phosphates (e.g. sodium triphosphate)
- phosphonates (e.g. DTPMP, ATMP)
- polyphosphates
- iminodisuccinat (IDS)
- enzymatic detergents.

4.3.8.2.1 Using EDTA

EDTA is the chelating agent used in the largest quantities. In 1999 in Western Europe, about 1/3 of the total use, 10685 tonnes, was used in industrial detergents. In 1997 it was reported that German dairies emitted 36 t/yr EDTA to water, i.e. 1 % of the country's total.

EDTA is mainly used due to its property as a chelating agent for calcium. In the dairy sector, the calcium content in milk is related to its protein content as calcium phosphocaseinate. EDTA may be used during CIP in dairies, as follows:

- to remove the fouling, known as milkstone which occurs on the stainless steel surfaces of milk processing machinery at temperatures from 70 – 80 °C. EDTA is used particularly on UHT equipment; membranes, e.g. UF and RO and for the preliminary cleaning of evaporators and spray driers. Most of this fouling is made up of stable denatured proteins. These are destabilised using EDTA, which then enables the surface to be cleaned. Scale also builds up in other applications and it is reported that skilled operators can tell when a periodic clean is required to prevent this. The deposits are composed of proteins, minerals and fat
- as a hardening stabiliser, to avoid precipitation of calcium when diluting concentrated alkaline detergents with water. High temperature alkaline cleaning may leave a carbonate layer that could cause biofilm build up. In multiple-phase cleaning, alkaline cleaning is followed, after intermediate rinsing, by nitric acid cleaning. The acid cleaning leaves a shiny surface in contact with the product. Single-phase cleaning, using EDTA to capture the calcium ions contained in water, reduces this effect and removes the acid step
- to bind calcium, magnesium and heavy metals to prevent sedimentation and incrustation, e.g. in the pipes and containers to be cleaned
- the bactericidal activity of cleaning and disinfection agents, especially towards gram-negative bacteria, increases when EDTA is incorporated, because of its ability to destroy the outer cell wall of these often resistant species
- to improve the re-use of chemicals and to reduce water and energy consumption related to single-phase cleaning compared with two-phase cleaning with caustic and nitric acid.

4.3.8.2.2 Known risks associated with using EDTA

There are no EU-15 risk assessments available for the other chelating agents, so only the risks associated with EDTA are known in detail. EDTA forms very stable and water-soluble complexes which are not normally degraded in biological WWTPs, so the heavy metals remain in the waste water and not in the sludge, and they are discharged to surface waters. The EDTA can then also remobilise heavy metals from the sediment of rivers. Furthermore, nitrogen contained in EDTA may contribute to eutrophication of waters. Many other chelating agents also contain either nitrogen or phosphorus.

Biological degradation of EDTA is slow and only proceeds under certain conditions, such as:

- having long hydraulic retention time and sludge age
- maintaining slightly alkaline conditions
- having a comparatively high EDTA concentration
- EDTA must not be present as a heavy metal complex.

[125, Boehm, et al., 2002, 126, Knepper and et al., 2001]

In addition, according to the draft risk assessment of 7 February 2003 under Regulation 793/93/EEC [201, EC, 1993], EDTA causes a risk to the aquatic environment when used as a chelating agent in some industries. The predicted no-effect concentration in surface waters is 2.2 mg EDTA/l.

4.3.8.2.3 Not using EDTA

It is reported that EDTA is not required for cleaning equipment and vessels which have contained raw milk, e.g. milk delivery tankers, during reception and storage of equipment and/or filling of fluid milk, where it is only important to remove fat films, or where separate cleaning stations are available. It is also not required for the cleaning of PET and glass bottles.

By optimising the milk processing time and using good quality raw milk, in which proteins have a higher heat stability, the formation of milkstone can be reduced (see Section 4.3.8.2.4).

Multiple-phase cleaning, i.e. using both acids and alkalis, exposes the protein deposit to an acid environment before the alkaline cleaning of heating equipment, so that the alkaline cleaning is intensified. This is then followed by rinsing and further low concentration nitric acid cleaning.

A change-over from single-phase cleaning with EDTA to two-phase cleaning with NTA as a substitute is possible at least for the lower temperature range of pasteurisers. The use of NTA is favoured in at least one MS and is banned in another. Furthermore, the degree of risk associated with the use of NTA or other chelating agents has not been investigated to the same extent as those of EDTA.

The replacement of ready-for-use cleaning agents by pure chemicals can possibly be efficient, but requires an optimal cleaning scheme and a precise design of flow dynamics, otherwise a loss of cleaning efficiency as well as substantial problems of hygiene are likely to occur. In addition, chelating agents are also necessary as solvents when pure chemicals are used. For this reason, a ready-for-use cleaning agent which is adjusted to special cleaning tasks and in which the combination of the individual components takes effect at a low concentration, can lead to much better cleaning results [228, Verband der Deutschen Milchwirtschaft (German Dairy Association), 1997].

The FDM sector has not identified a way of totally eliminating the use of EDTA, although there may be scope for reducing the operations it is used for and/or the frequency with which it is used. An example of a strategy to minimise the use of EDTA is described in Section 4.3.8.2.5.

4.3.8.2.4 Reducing EDTA use by minimising milkstone formation by production planning

Description

Milkstone formation can be reduced by using milk with a high protein stability. The stability of milk protein is reduced by repeated processing and pumping. Production planning to prevent reprocessing can, therefore, contribute to the prevention of milkstone build-up and the consequent use of EDTA. Milkstone formation is also higher if the milk has a high micro-organism count, so can be reduced if adequate hygiene conditions are enforced. There are a number of other factors which cause protein instability in milk, such as enzyme activity.

Achieved environmental benefits

Optimal use of milk and reduced EDTA consumption.

Operational data

By optimising the milk processing time and using good quality raw milk, in which proteins have a higher heat stability, the formation of milkstone can be reduced. The milkstone reduces the efficiency of the heat exchange and the flowrate, especially in plate heat-exchangers. Consequently indirect heat-exchangers have to be cleaned no more than 8 – 9 hours after start-up. Longer times between cleaning may cause a build-up of milkstone which is more difficult to remove. A differential pressure gauge can be used to monitor the pressure drop between the processor inlet and outlet to judge when the equipment needs to be cleaned. Low milk quality affects the running time because the heat stability of the proteins is reduced and they precipitate easier on the surfaces.

The heat stability of milk may be checked by heating the milk to its boiling point and evaluating the amount of sediment produced or by a simple test carried out by mixing milk and ethanol and checking if any precipitation occurs on glass surfaces. More stable proteins require higher concentrations of ethanol for precipitation to occur.

The milk stability also determines the products which milk can be used to make. For example, milk containing higher stability proteins is required for drinking milk than for cheesemaking.

Applicability

Applicable in all dairies.

Driving force for implementation

Optimal use of milk and reduced EDTA consumption.

Reference literature

[245, Barale M., 2004]

4.3.8.2.5 Example of a strategy to minimise the use of EDTA

An example dairy processing whey used 60 tonnes of EDTA per year before it started to apply an enzymatic technique. Two million litres of whey per day, equivalent to 700000 t/yr, are processed in this installation to manufacture whey protein concentrate, functional whey protein concentrate products and whey protein extract. 13500 tonnes of lactose, 10000 tonnes of whey permeate, 5500 tonnes of whey protein extract, 2000 tonnes of sour whey powder and 1500 tonnes of milk protein concentrate are also produced.

The company has tried to reduce its emissions of EDTA. In early 1997, caustic was added to the detergent with the aim of reducing EDTA release by 30 %. This did not prove efficient. Also in 1997, the company tried NTA as a substitute. This reduced the EDTA use by 50 %, but this attempt was abandoned because of poor cleaning results, leading to a decrease in the microbiological quality of products.

An enzyme-based procedure was tried in the main installation for 1.5 years in 1998/99. The composition of the detergent was changed. It was found that chlorine and EDTA could be substituted by IDS for dissolving inorganic materials. This did not prove successful, probably because the cleaning, which was reportedly too effective, impeded the formation of the secondary membrane coating layer needed for protein filtration. This happened again when the membranes were replaced, so the company decided to abandon this option.

A similar enzyme-based procedure, combined with the use of phosphonates as chelating agents, was used in 1999 after being tested as an alternative procedure in a pilot plant in 1998. EDTA was not used at all. This resulted in difficulties in removing calcium compounds, especially calcium phosphate. This led to bacterial contamination and reduced performance.

Consequently, the company decided to combine the last technique with intermittent cleaning steps using EDTA a few times per month and by recycling the cleaning solution when cleaning NF membranes [127, Strohmaier, 2002].

4.3.9 CIP (cleaning-in-place) and its optimal use

Description

CIP systems are cleaning systems that are incorporated into equipment and can be calibrated and set to use only the required quantities of detergents and water at the correct temperature (and sometimes pressure) conditions. Incorporation of a CIP system can be considered at the equipment design stage and installed by the manufacturer. Retrofitting a CIP system may be possible, but is potentially more difficult and expensive. CIP systems can be optimised by incorporating the internal recycling of water and chemicals; carefully setting operating programmes, which coincide with the real cleaning requirements of the process; using water efficient spray devices and by removing product and gross soiling prior to cleaning. Equipment correctly designed for CIP cleaning should have spray balls located so that there are no “blind spots” in the cleaning process.

Secondary water from, e.g. RO and/or condensate may be suitable for direct use in pre-rinsing in CIP, or for other uses after treatment. Opportunities for re-using secondary water in CIP at dairies are shown in Table 4.107. The use of such water for pre-rinsing may depend on whether it is possible to recover materials for re-use in the process. If this is the case, then drinking water quality water is required.

The chemicals used in CIP are normally an alkaline solution, based on caustic, to detach and remove fat and protein layers and an acid solution, e.g. based on HNO_3 , to detach and remove mineral layers. In many cases, the acid step is not required. Cleaning using only the caustic step, is sometimes called single-phase cleaning. Chelating agents, normally based on EDTA, are sometimes added to the alkaline solution to both prevent the precipitation that normally occurs when alkaline concentrates are diluted and to dissolve calcifications and deposits. The chelating agents and other additives can be harmful to the environment. Sections 4.3.8.2 to 4.3.8.2.5 inclusive contain further information about the use of chelating agents, including EDTA. Some advantages of single-phase cleaning are, that it reduces water and energy consumption and increases the speed of cleaning. Using both acid and alkali cleaning solutions requires two cleaning solution tanks with additional pipework, intermediate flushing and consequently use more water and energy and take longer.

The choice of the cleaning agents used depends on a number of factors and cannot be determined in general. The simple basic materials such as caustic and HNO_3 , as well as specially blended, ready-made cleaning agents are available for particular applications. Care should be taken to ensure that chemicals which are not really required are not used, e.g. chelating agents like detergents containing EDTA are not required for the cleaning of milk tankers and raw milk storage tanks.

An example of a CIP system is shown in Figure 4.21.

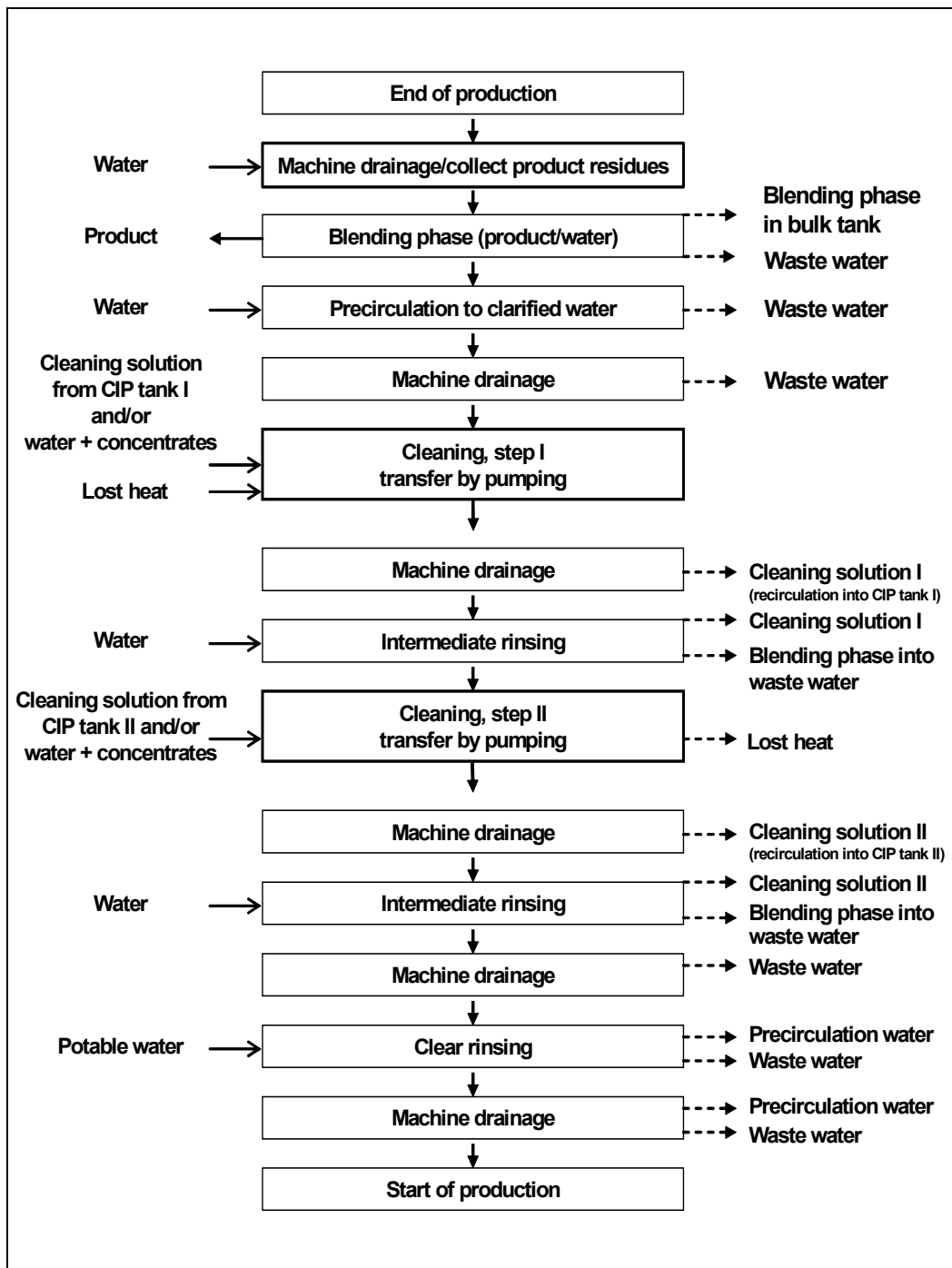

Figure 4.21: Flow sheet of a cleaning-in-place system

It is reported that parallel or serial cleaning of tanks and parallel cleaning of pipe systems need to be avoided. Both parallel and serial cleaning of tanks results in excessive mixing of pre-rinse and cleaning solution, and cleaning solution and final rinse. This limits the re-use of cleaning solution and energy. In a parallel configuration it can be difficult to achieve the required distribution of the flow through more than one tank and the CIP return from the tanks needs a different residence time. When switching from pre-rinse to cleaning solution or from cleaning solution to final rinse this results in a long mixing zone. In a serial configuration the content of the piping between tank I and II will result in a long mixing zone as well if the content is not drained. When the cleaning solution arrives in tank I (drained), the pre-rinse content of the piping may become mixed with cleaning solution in tank II (drained before).

Achieved environmental benefits

A reduction in the consumption of water, detergents and the energy needed to heat the water are achievable because it is possible to set the consumption levels, specifying the use of only that required for the surface area to be cleaned. It is possible to recover and re-use water and chemicals within the system. There is a subsequent reduction in the amount of waste water generated.

Cross-media effects

Possible energy use associated with pumping the water and detergent.

Operational data

Optimising the CIP systems can, e.g. minimise the quantity of the cleaning and disinfection agents used, by recirculating cleaning solutions. Some losses will still occur with contaminated water and solutions, therefore, still need to be recharged. For example, when the particulate content of cleaning solution reaches a specific level it will need to be disposed of. An additional effect of recirculating the solutions is that a partial recuperation of the thermal energy is possible.

CIP systems can be much more efficient than manual cleaning, but they need to be designed and used to optimise their potential advantages. Design and operational features which minimise water consumption, cleaning chemicals consumption and which maximise product recovery include:

- dry product removal before the start of the wet cleaning cycle by, e.g. gravity draining, pigging (see Section 4.3.3) or using compressed air (see Section 4.3.4)
- pre-rinsing using small quantities of water, which, in some circumstances, may be combined with either returning the pre-rinse-water to the process for re-use or recovering it for disposal
- using a turbidity detector to optimise both the recovery of material/product from water and the re-use of cleaning water, during pre-rinsing (see Section 4.1.8.5.3)
- optimising the CIP programme for the size of plant/vessel and type of soiling, with respect to chemical dosing, water consumption, temperature, pressure and cleaning and rinsing times
- automatic dosing of chemicals at the correct concentrations
- internal recycling of water and chemicals
- re-using of intermediate/final water for pre-rinsing
- recycle control based on conductivity (see Section 4.1.8.5.2) rather than time
- water efficient spray devices
- correct selection of CIP detergents.

It is common practice for the final rinse-water to be re-used, either for pre-rinsing, intermediate rinsing or the preparation of cleaning solutions. The aim of the final rinse is to remove the last traces of cleaning solutions from the cleaned equipment. Clean water is used and the rinsing water, which returns to the central CIP unit, is clean enough to be re-used, instead of being discharged to the drain. The recovery of the final rinsing water requires a connection from the CIP return pipe to the pre-rinsing tank. A conductivity transmitter is used to divert the water, e.g. to the pre-rinsing tank.

For large dairy installations with highly branched pipework, a centralised CIP system may not be appropriate. Often, the distances are too long and this leads to considerable losses of heat, detergents and water, as well as excessive pumping capacities. In such cases, several small CIP systems can be used. These can be supplied with the necessary cleaning solutions from the centralised CIP system, via a closed pipeline.

For some applications, such as some small or rarely used installations or where the cleaning solution becomes highly polluted, such as UHT installations, membrane separation plants, and the preliminary cleaning of evaporators and spray driers, single-use systems are used. In these systems, cleaning agents are not re-used, because they may impede the cleaning effect in other installations.

Applicability

Applicable to closed/sealed equipment through which liquids can be circulated, including, e.g. pipes and vessels.

Economics

The capital cost is high. Reduced costs of water, energy and chemicals.

Driving force for implementation

Automation and ease of operation. Reduced requirement to dismantle and reassemble equipment.

Example plants

CIP is used in many dairies and breweries and in the manufacture of instant coffee. It is also used to clean the equipment used for the stabilisation of wine.

Reference literature

[1, CIAA, 2002, 9, Verband der Deutschen Milchwirtschaft (German Dairy Association), 1999, 42, Nordic Council of Ministers, et al., 2001, 224, Portugal-FIPA, 2003, 228, Verband der Deutschen Milchwirtschaft (German Dairy Association), 1997, 239, CIAA-EDA, 2003]

4.3.10 Frequent and prompt cleaning of processing equipment and materials storage areas

See also Section 4.3.1.

Description

Areas where raw materials, by-products, and waste are stored can be cleaned frequently. The cleaning programme can cover all structures, equipment and internal surfaces, material storage containers, drainage, yards and roadways.

Achieved environmental benefits

The adoption of thorough cleaning and good housekeeping as a routine, reduces malodorous emissions and the risk of hygiene and nuisance problems from pests and vermin.

Cross-media effects

Water is consumed during the cleaning process, although the extent depends on the amount of dry cleaning carried out before water is used. There may be opportunities to re-use water from sources within the installation and the WWTP.

Operational data

When ground meat residues, particularly meat mix for salami production or for sausage making, from equipment such as bowl choppers, sausage fillers and from floors, is left standing, it sticks to the surfaces and makes subsequent cleaning difficult. Cleaning such equipment immediately after the end of production minimises the cleaning efforts and the need for water and detergents. The ground meat residues are manually removed to the maximum practical extent, prior to cleaning and sending to the rendering installations.

If raw material containers are emptied and washed frequently, e.g. daily, then decomposing and malodorous materials will not accumulate over long periods of time. Delays in dispatch can provide sufficient time for material to deteriorate and if storage, particularly badly controlled storage, continues on a site, even briefly, odour problems can arise. Even facilities with a quick turnover of clean material can generate odour problems, if good hygiene practices are not observed. For example, sorted fruit and vegetables, peel and cutting residues and organic waste can be emptied daily.

Applicability

Applicable to all FDM installations.

Example plants

Widely applied, e.g. in fruit and vegetable stores.

Reference literature

[41, Nordic Council of Ministers, 2001]

4.3.11 Using metered water dispensers and/or high pressure low volume (HPLV) sprays for cleaning trucks

Description

Using metered water dispensers and/or high pressure low volume (HPLV) sprays for cleaning trucks can reduce water consumption and waste water pollution.

Achieved environmental benefits

Reduced water consumption and waste water pollution.

Operational data

Grape containers are reportedly cleaned using this technique. The cleaning water is drained.

Applicability

Applicable to FDM installations where materials are delivered in trucks.

Economics

Reduced water and waste water treatment costs.

Example plants

Used in wine processing installations.

Reference literature

[134, AWARENET, 2002]

4.4 Techniques for minimising air emissions

The types of environmental impacts made by FDM unit operations are summarised by codes in Table 3.4 and the codes used for emissions to air are explained in Table 3.5.

This section is divided in three main sections. Section 4.4.1 describes a systematic approach to air emissions control, from the initial definition of the problem to how to select an optimum solution. Section 4.4.2 describes process-integrated techniques that are used to prevent or minimise air emissions. Finally, Section 4.4.3 describes end-of-pipe abatement techniques used after process-integrated measures.

4.4.1 Air emissions control strategy

The strategy is divided into a number of evaluation stages. The extent to which each stage needs to be applied depends on the particular installation situation and certain stages may or may not be required to achieve the levels of protection sought. The strategy can be used for all air emissions, i.e. gases, dust and odours, some of which are caused by VOC emissions. Odour is mainly a local issue based on nuisance, but as it often arises due to the emission of VOCs, these also need to be considered. For each stage, odour is used as an illustrative example. The approach of this example, summarised in Figure 4.22, is particularly useful for large operating sites where there are a large number of discrete odour sources and where the major contributors to the overall malodorous discharge are not fully understood.

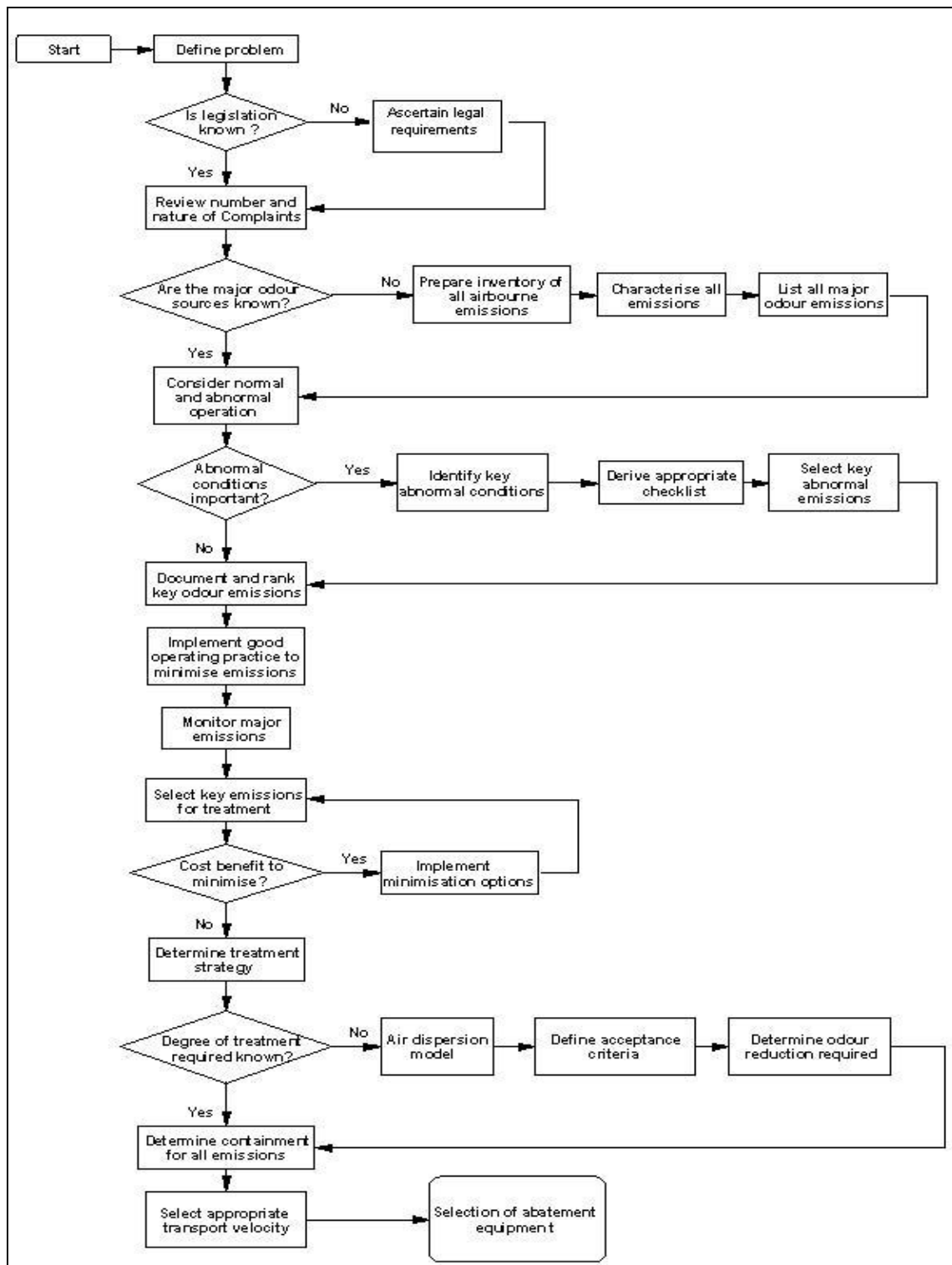

Figure 4.22: Flowchart for the selection of odour abatement techniques
 [34, Willey A R and Williams D A, 2001]

4.4.1.1 Step 1: Definition of the problem

Information is gathered about legislative requirements regarding air emissions. The local setting, e.g. weather and geographical conditions, may also be relevant when defining the problem, e.g. for odour.

4.4.1.1.1 Odour example

People working at the installation will generally know well what the odour problems are and can assist a consultant or person unfamiliar with the local situation.

First, the number and frequency of complaints and the characteristics related to odour can be reviewed. The location of the complainants in relation to the installation, together with any comments made by the complainants or the local authority representatives help to identify what needs to be addressed. A complaints logging system can be set up, which includes a system for answering all complaints made directly to the installation with either a telephone call or personal visit. If the exact processing conditions at the time of the complaint are examined and documented, this can assist in locating the odour sources which need to be controlled.

Any correspondence with the local authority or the local community can be reviewed. The level of activity of the local community together with the approach and actions taken by the local authority representatives can enable the severity of the problem to be established and influence the likely time-scale available to modify the process or install an abatement plant.

Finally, the prevailing local climatic conditions can be established. In particular, the prevailing wind direction and wind speed and the frequency of inversions. This information can be used to ascertain whether the complaints are largely generated as a result of certain weather conditions or are generated by specific operations carried out at the installation.

4.4.1.2 Step 2: Inventory of site emissions

The inventory includes normal and abnormal operational emissions. Characterising each emission point allows subsequent comparison and ranking with other site emission points.

A systematic way to identify normal operational air emissions is to work through each process and identify all potential emissions. For example, this study may cover the following site operations:

- raw material delivery
- bulk raw material storage
- minor raw material storage, e.g. drums and sacks
- production
- packaging
- palletising/warehousing.

The study can be conducted with varying degrees of sophistication. Process flow sheets or process and instrumentation diagrams can be used during a tour around the site to systematically identify all the emission sources.

Depending on the severity of the problem and the key site operations that cause the problem, it may be necessary to extend this analysis to cover abnormal and even emergency situations. A checklist approach in conjunction with a process and instrumentation diagram, may be used. The range of keywords to incorporate into the checklist will probably differ considerably from operation to operation.

4.4.1.2.1 Odour example

An odour problem may be related to a continuous discharge from the installation that conveys a distinctive odour to the surroundings. Treating the major emission will, in many cases, alleviate the problem and reduce or eliminate the receipt of complaints. In other cases, the removal of the major odour source will result in other odour sources from the site becoming more prominent. These odour sources may have characteristic odours different from those of the major odour source. This situation can subsequently result in further complaints and require further capital expenditure in addition to that already assigned to treat the major odour source. It is, therefore, important to fully evaluate the range of malodorous emissions from the site and to identify the discrete emissions with the greatest potential to cause odour complaints. Table 4.26 shows one way of recording information of normal operational odour sources. It may be the case that odour problems only arise during abnormal operations. A typical checklist for abnormal operations is shown in Table 4.27.

Odour Source: _____	Examples: _____
Type of discharge	Forced/natural/ventilation
Process operation conducted	Heating/cooling/maintenance/cleaning
Continuity of emission	Continuous/discontinuous/periodic
Operational time	Duration per hour/per day/per production cycle
Discharge arrangement	Stack/manhole/in building/atmospheric
Discharge configuration	Stack diameter/elevation of discharge
Description of odour	Sweet/sour/pungent/fruity
Strength of odour	Very faint/faint/distinct/strong/very strong
Estimated flowrate	Measurement/fan curves/estimate
Location in installation site	Co-ordinates of discharge
Operation	Normal/abnormal/emergency
Overall ranking	E.g. -10 to +10 or 0 to 10

Table 4.26: Data sheet for collecting information on malodorous emissions

Parameter	Examples
Loss of containment	Overfilling/leaks/failure control
Disposal emptying	Waste materials and process materials
Potential for material to enter process	Steam coil breakage
Runaway reaction	Failure to input a material or to control temperature
Corrosion/erosion	Inspection frequency
Loss of services	Fail safe instrumentation
Control/manning	Level of control and supervision
Ventilation/extraction	Design basis correct
Maintenance/inspection	Frequency, what is required?
Start-up/shut-down	Implications for downstream operations
Throughput changes	100 %, 110 % of production + low production
Formulation changes	Malodorous ingredients

Table 4.27: Checklist for abnormal operation

The malodorous emissions can be ranked in terms of the severity of their impact on the surrounding environment. A possible system to devise a ranking order could start with grouping the emissions into categories such as major, medium and minor according to their odour characteristics and the related complaints. The ranking within each category is strongly influenced by the strength of the perceived odour from the source together with the associated airflow and nature of operation, i.e. continuous or non-continuous. This process may require a degree of professional judgement in addition to the factors detailed above.

4.4.1.3 Step 3: Measurement of major emissions

Air emissions are quantified for determining priorities for prevention and treatment. The measurement will allow the emissions to be ordered in terms of the magnitude of their impact.

4.4.1.3.1 Odour example

The quantification of the major malodorous emissions is undertaken using the following formula:

$$\text{Odour emission} = \text{measured odour level (OU/m}^3\text{)} \times \text{associated volumetric airflow (m}^3\text{/sec)}$$

Odour measurement is difficult and the results may have a wide statistical deviation. Nevertheless, a quantitative measurement of odour may ultimately be required by a contractor supplying abatement equipment or to demonstrate compliance with legislation.

If the key malodorous emissions are known, together with the related flowrates and with the physical location of the emissions within the site, this will allow a possible treatment scenario to be developed. Table 4.28 is based on a real, but unspecified situation simplified to illustrate the principle. It shows the calculation of odour emissions and, based on this level, this technique proposes an “emission ranking”. This allows a tentative treatment strategy to be developed, however it does not yet examine whether further account needs to be taken of the operational hours or the impact of the major emissions, including their individual characteristics such as whether the odour is strong, sweet or pungent.

Source	Flowrate (m ³ /s)	Odour level (OU/m ³)	Odour emission (OU/s)	Emission ranking based on the odour emission*	Operational hours (h/yr)	Odour description
Raw material handling	180000	1610	22	5	480	
Raw material heating	172800	1250	16	6	960	
Process heating	3960	11290	3.4	7	2100	
Vacuum generation	1440000	17180	1909	2	5760	
Fat trap	5760	90	0.04	8	6240	
Vent to air from process plant	6912000	350	190	4	48	
Packing hall	45720000	80	275	3	5760	
Waste facility	12600000	2690	2611	1	387	

*This does not take account of odour impact, exposure times or other characteristics. Number 1 has the highest priority for treatment as it has the highest emission level, down to 8 which is the lowest.

Table 4.28: A typical odour measurement programme, using simplified measurements from an unspecified food manufacturing site [34, Willey A R and Williams D A, 2001]

Air dispersion modelling can enable the impact of the major measured emissions to be fully quantified. The impact, in this respect, is the resultant ground level odour concentration of the total emissions from the site at varying distances from the site boundary in relation to climatic conditions, to determine any required action to control odour emissions. If there are several odours or components from the same source, which is usually the case, these may all be considered together. If there is more than one odour source, it is necessary to consider each one separately.

4.4.1.4 Step 4: Selection of air emission control techniques

An inventory of emissions, immissions and complaints, e.g. in the case of odour, which often arises due to the emission of VOCs, can identify the major sources of air emissions from the site that need to be part of a treatment plan or strategy. It enables any sources whose impact can be eliminated or, if not, reduced to be identified. Control techniques include process-integrated and end-of-pipe treatment.

Process-integrated treatment includes substance related measures, such as selecting substitutes for harmful substances such as carcinogens, mutagens or teratogens; using low emission materials, e.g. low volatility liquids and low fine dust solids and process related measures, such as using low emission systems and production processes. If, after applying process-integrated measures, emission reduction is still required, further control of gases, odour/VOCs and dust by the application of end-of-pipe techniques may be needed.

4.4.2 Process-integrated techniques

Process-integrated procedures to minimise air emissions generally have other environmental benefits, such as optimising the use of raw materials and minimising waste generation. These environmental benefits are listed where they are associated with techniques in this chapter. Some of the techniques described as air abatement techniques are also integrated in the process and enable the recovery of materials for reprocessing, e.g. cyclones (see Section 4.4.3.5.2).

4.4.3 End-of-pipe air treatment

Sections 4.4.3.1 – 4.4.3.13 describe some end-of-pipe abatement techniques used to treat air emissions within the FDM sector. Chapter 2 covers the processing unit operations used in the FDM sector but does not describe end-of-pipe treatment techniques.

End-of-pipe measures are designed to reduce not only the mass concentrations, but also the mass flows of the air pollutants originating from a unit operation or a process. They are in normal use during the operation of the plant.

Table 4.29 lists some widely used end-of-pipe air treatment techniques.

Treatment processes	
Solid and liquid pollutants	Gaseous pollutants and odour/VOCs
Dynamic separation	Absorption
Wet separation	Carbon adsorption
Electrostatic precipitation	Biological treatment
Filtration	Thermal treatment
Aerosol/droplet separation*	Non-thermal plasma treatment
	Condensation*
	Membrane separation*
*Not described as an air emission minimisation technique in this document	

Table 4.29: End-of-pipe air treatment techniques
[34, Willey A R and Williams D A, 2001, 65, Germany, 2002]

Separation of dispersed particles/dust uses the application of external forces, i.e. primarily gravitational, inertial and electrostatic forces. Use of physical dispersion, via chimney stacks and increasing the dispersion potential by extending the height of the discharge stack or increasing the discharge velocity, is also practised.

The characteristics of the emission determine the selection of the most appropriate end-of-pipe abatement technique. This may need some flexibility, to enable the treatment of additional sources identified at a later date. Table 4.30 shows the key parameters for the selection procedure.

Parameter	Unit
Flowrate	m ³ /hr
Temperature	°C
Relative humidity	%
Typical range of components present	–
Dust level	mg/Nm ³
Organic level	mg/Nm ³
Odour level	OU/Nm ³

Table 4.30: Key parameters for the end-of-pipe selection procedure

In some cases, the components of the emission are easily identified. In the case of odour, the emission to be treated usually contains a complex cocktail and not just one or two readily definable components. The abatement plant is, therefore, often designed based on experience within other similar installations. The uncertainty caused by the presence of a considerable number of airborne components may necessitate the need for pilot plant trials. The flowrate to be treated is a major parameter in the selection process and very often the abatement techniques are listed against the optimum flowrate range for their application.

The purchase of an abatement plant will normally include a number of guarantee statements, e.g. relating to mechanical and electrical reliability for a period of at least one year. As part of the selection and procurement procedure, the supplier will also require information regarding the removal efficiency of the process. The form of the process guarantee is an important part of the contract. For example, guarantee statements relating to odour removal performance can take a number of forms. In the absence of any olfactometric data then the guarantee might simply state “no perceivable odour outside the process boundary or outside the installation site”.

Extremely high standards for clean gas dust concentrations can be achieved by using two-stage layouts of high performance separation techniques, e.g. using two fabric filters or using them in combination with HEPA filters (described in the “Waste water and waste gas treatment BREF” [217, EC, 2003] or with ESP filters.

Table 4.31 shows a comparison of the performance of some separation techniques.

Technique	Particle size μm	% collection efficiency at 1 μm	Maximum operation temperature °C	Range of achievable emission levels mg/Nm ³	Comments
Cyclone	10	40*	1100	25 – 100	Coarse particles. Used to assist other methods
Wet separation	1 – 3	>80 – 99	Inlet 1000 Outlet 80	<4 – 50	Good performance with suitable dust types. Acid gas reduction
Dry ESP	<0.1	>99 depending on design	450	<5 – 15 (pre-abatement >50)	Four or five zones. Usual application is pre-abatement
Wet ESP	0.01	<99	80	<1 – 5 optically clear	ESP with two zones in series. Mainly mist precipitation
Filtration – i.e. fabric filter	0.01	>99.5	220	<1 – 5	Good performance with suitable dust type
Filtration – i.e. ceramic filter	0.01	99.5	900	0.1 – 1	Very good performance with suitable dust types

* For larger particle sizes and high efficiency cyclones, collection efficiencies of around 99 % can be achieved.

Table 4.31: Comparisons of some separation techniques [65, Germany, 2002, 199, Finland, 2003]

4.4.3.1 Optimal use of air abatement equipment

Description

The requirement for abatement equipment to run may vary depending on the recipe, e.g. in the case of odour. If there are processes or recipes which do not require air abatement equipment to be used all of the time, its use can be managed to ensure that it is available and at the required operating condition when it is required.

It can be installed in such a way that it cannot be bypassed by the individual operating it, but when the conditions which require the abatement do not apply, then managers can bypass it. For example, the manager can keep control of the keys which give access to the controls which enable the equipment to be bypassed and they can also ensure that it is switched on again in time to have reached its optimum operating condition as soon as it is required.

Achieved environmental benefits

Reduced emissions to air.

Operational data

When an example wet petfood canning installation, which had been operating without emitting malodorous substances, started to make another product, odour became a significant problem, because the existing odour control measures were not suitable for the new recipe. Recipe changes have also led to fluctuating odour problems at animal feed mills, where on a batch basis, fish-oils or molasses are added. These examples demonstrate the varying need for abatement, even within some individual installations.

As well as ensuring that the abatement equipment is switched on, for the efficient prevention of emissions to air, the operating conditions need to be correct. For example, at smokehouses for meat or fish, and at coffee roasting installations using thermal oxidation to destroy odours, these thermal oxidisers do not operate effectively until they reach the combustion temperatures of the pollutants, so they need to be started up in time for these temperatures to be reached in the combustion chamber (see Sections 4.4.3.11.1 and 4.4.3.11.3).

Applicability

Applicable where air abatement equipment is used.

Driving force for implementation

Prevention of air emissions.

Reference literature

[182, Germany, 2003, 234, UK, 2003, 235, DG Environment, 2003]

4.4.3.2 Collection of air emissions at source – local exhaust ventilation

Description

Adequate ventilation of the workplace and specific process operations are required to ensure suitable working conditions, provide oxygen for combustion for oil- or gas-fired equipment and to form part of the system of controlling emissions to air. General and local ventilation removes, e.g. products of combustion from oil- and gas-fired equipment and odours, vapours and steam from cooking processes.

Local exhaust ventilation can provide protection from hazards to health arising from some cooking fumes, such as those involving direct application of heat to the food. Unless such ventilation is designed to be kept clean and free from fat residues it can lose efficiency and cause fire risks. If incoming replacement air is too hot or too cold, there is a risk that staff will switch it off. Where incoming air is drawn in naturally, some means of control over pest entry is usually required. The ventilated air can be extracted to an abatement plant and, in some cases, it may be recirculated, taking into consideration the hygiene requirements. In some applications, it is possible to collect airborne materials for re-use.

Enclosure of air emissions sources, and the use of local exhaust ventilation uses considerably less energy than treating the whole room volume. Air emissions include, e.g. odours, which often arise due to VOC emissions and dusts, such as grain and flour. To be effective, the dimensions of suction capacity need to be adequate and features such as guide plates and hoppers with swing flaps and lids can contribute to the minimisation of dust and gas emissions.

The identified emissions requiring treatment are ducted at source and possibly combined before being transported to an abatement technique.

The objective of the equipment is that it prevents, where possible, and controls to a minimum, the escape of all air emissions. The following are examples of areas of concern:

- vehicle loading/unloading points
- access points to the process plant
- open conveyors
- storage vessels
- transfer processes
- filling processes
- discharge processes.

Achieved environmental benefits

Reduced air emissions and potential re-use of airborne materials.

Cross-media effects

Energy consumption.

Operational data

The majority of abatement techniques are designed based on the volumetric airflow to be treated. This requires effective containment of the separate emissions whilst still maintaining an adequate volumetric flowrate of air to ensure no ingress of air emissions into the working environment.

Examples where air is recirculated include:

- recirculation of coffee roasting gases from continuous or discontinuous roasting
- dust-laden feed air can be recirculated to pneumatic conveyors, thereby also collecting the dust for re-use
- smoke from smoking chambers can be partially or wholly recirculated.

Records of design criteria, performance tests, maintenance requirements and tests and inspections can facilitate future maintenance, modification and testing against the original specification.

Applicability

Applicable to all FDM installations with emissions to air, e.g during loading and unloading vehicles; at hoppers, transfer points, chutes, loading pipes.

Economics

There can be considerable cost savings made in the capital cost of the abatement plant by minimising the volumetric flowrate requiring treatment. It is important to distinguish between general ventilation of the installation and local exhaust ventilation. General ventilation involves the movement of much larger volumes of air, so uses more energy and is more expensive.

Driving force for implementation

Occupational health.

Reference literature

[34, Willey A R and Williams D A, 2001, 65, Germany, 2002, 233, Health and Safety Executive, 2000]

4.4.3.3 Transport of ducted emissions to the treatment or abatement equipment

Description

Ducted emissions are transported to the end-of-pipe treatment or abatement equipment. There are three major factors to be taken into account when designing equipment to transport emissions to the treatment plant. These are transport velocity, ventilation ducting design and discontinuous flows.

Achieved environmental benefits

Reduced air emissions.

Cross-media effects

Energy consumption.

Operational data

Transport of ducted emissions to the treatment plant needs careful consideration, to minimise any operational problems. In particular, the potential for particulate deposition and the potential for condensation of water and other airborne contaminants can result in severe fouling, requiring frequent cleaning and may lead to hygiene problems. Incorporating cleaning points and drain valves in the ventilation ductwork enables cleaning to remove accumulated material.

Selecting a low transport velocity minimises extraction fan costs. If the presence of dust is considered to be a problem, then a transport velocity of not less than 10 m/s is chosen. A transport velocity of 5 m/s is considered to be a minimum.

If the presence of dust is likely to cause operational problems, in spite of operation at high transport velocities, then a plenum chamber, i.e. an enlarged duct where the particulate laden airstreams enter and the overall velocity is reduced to between 2.5 and 5.0 m/s, can be installed. The chamber is purposely designed to enhance particulate deposition and is fitted with a hopperside and a number of clean-out doors along its length. The outlet ducting from the plenum chamber is reduced in diameter to reattain the system transport velocity.

The extract ventilation ducting is designed with a common transport velocity throughout, so that the air velocity in all duct and exhaust branches is the same. The entry of branches to the main duct can be angled at a maximum of 45°, although an angle of 30° is more efficient. At the entry point of the branch into the main duct, the main duct diameter gradually increases at an angle of 15°. To ensure that the required performance is achieved, the design of the ventilation ductwork is frequently conducted by a specialised contractor.

Discontinuous exhaust flows are quite common where there are a number of exhausts being discharged to a central treatment plant, if some are continuous and others are discontinuous. This may give the potential for certain exhausts to contaminate other process emissions during a failure mode and the operation of the fan under varying load conditions may need to be considered.

The control system required for this type of arrangement can be complex. For instance, the fan can be specified as a single speed system, so that it always pulls the design flowrate. This system requires an additional inflow to the ventilation system to rectify any deficiency in the design flowrate once a process goes off line. This additional inflow could be extracted from the operator workplace or that used to provide additional ventilation to the building. Alternatively, a fan operating with a frequency inverter can be used. The fan speed would then be controlled by a static pressure measurement at the inlet to the fan and downstream of the last branched entry. This system would result in a variable flowrate to the treatment plant in line with the particular processes that are in operation. The choice of a fixed speed or inverter system largely depends on the type of abatement plant installed and whether there are any treatment efficiency disadvantages with a changing flowrate.

Applicability

Applicable to all FDM installations with emissions to air.

Reference literature

[34, Willey A R and Williams D A, 2001]

4.4.3.4 Selection of end-of-pipe odour/VOCs abatement techniquesDescription

When selecting odour abatement techniques, the first stage is to analyse the flowrate, temperature, humidity, and the particulate and contaminant concentrations of the malodorous emission. Odours often arise due to the emissions of VOCs, in which case the abatement technique applied needs to take account of toxic and flammable hazards. A summary of generalised criteria for selecting odour/VOC abatement techniques is shown in Table 4.32, where these parameters are shown in a matrix against some generic types of abatement equipment available. Table 4.32 is a guideline and does not contain the full details about the advantages and limitations of individual techniques. Each property of the malodorous emission has been segregated into two or three ranges. In this example, flowrate is segregated into two ranges, i.e. above and below 10000 m³/h. Each cell in the matrix has been assigned a value of between 0 and 3, with a value of 3 representing the optimum operating condition.

For each of the abatement techniques, the relevant range of each of the malodorous emission properties is totalled. This allows a simple ranking system, by which the techniques with the highest scores are considered further. Typically, three to five abatement techniques are carried forward to the next stage in the selection procedure.

Treatment	Flowrate (m ³ /hr)		Temperature (°C)		Relative humidity (%)		Particulate (mg/Nm ³)		Contaminant concentration (mg/Nm ³)		Score	
	<10000	>10000	<50	>50	<75	>75	0	<20	>20	<500		>500
Physical	1	2	1	2	2	1	1	1	2	1	0	
Absorption-water	1	1	2	1	2	1	1	1	3	1	0	
Absorption-chemical	2	2	2	1	2	1	2	1	1	2	1	
Adsorption	3	1	3	0	2	0	3	0	0	2	1	
Biological	3*	2*	3	0	2	2	3	1	0	3	0	
Thermal oxidation	3	1	1	3	2	1	3	2	1	3	3	
Catalytic oxidation	3	2	1	3	2	1	3	0	0	3	3	
Plasma	2	3	3	1-2	3	2	3	3	1-2	3	2	
Score rating	Description											
0	This treatment is not suitable or unlikely to be effective, so is not considered as part of the selection procedure.											
1	Worthwhile considering although unlikely to be the best choice											
2	The abatement technique is well suited for this condition											
3	Represents the best operating condition for the given treatment system											
*	Depends on the surface area											

Table 4.32: Summary of generalised criteria for selecting odour/VOC abatement techniques

The effectiveness or required performance is considered next. This can be assessed using professional guidance and information from the manufacturers of the abatement techniques.

The next step in the selection procedure is a feasibility assessment. The capital and operating costs, space requirements and whether the abatement technique has been proven to be applicable in a similar process, are all considered.

Figure 4.23 shows a flow sheet that summarises this process of selecting end-of-pipe odour/VOCs abatement techniques.

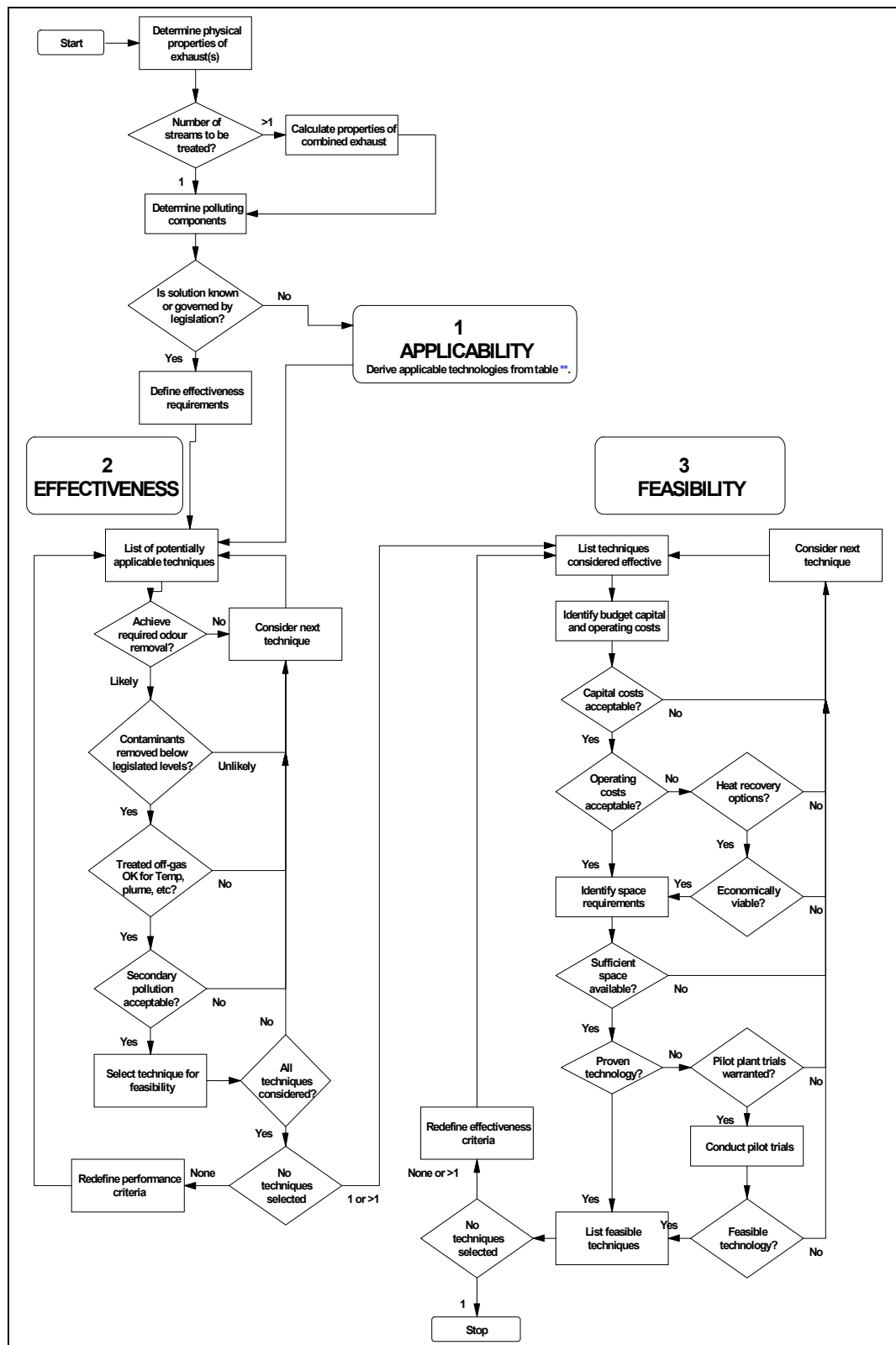

Figure 4.23: Flow sheet for the selection of odour abatement equipment (**see Table 4.32)

Achieved environmental benefits
Reduced odour emissions.

Applicability
Applicable to all FDM installations.

Driving force for implementation

Reduced odour emissions.

Reference literature

[34, Willey A R and Williams D A, 2001]

4.4.3.5 Dynamic separation techniques

The basis for the separation and removal of particles in dynamic separators are the field forces, which are proportional to the mass of the particles. Hence, gravity separators, deflection or inertia separators and centrifugal separators such as cyclones, multiclones and rotary flow dedusters, are all dynamic separators. They are mainly used for separation of large particles only ($>10\ \mu\text{m}$) or as an initial step before the removal of fine dust by other means.

4.4.3.5.1 Separators

Description

The waste gas stream is passed into a chamber where the dust, aerosols and/or droplets are separated from the gas under the influence of gravity/mass inertia. The effect is increased by reducing the gas velocity by design means, e.g. baffles, lamellae or metal gauze.

The design should ensure a good uniform speed distribution inside the vessel. Preferential flows have an adverse effect on efficiency. The use of internal obstructions in the inertia separator enables operation at higher speeds, which represents a reduction in volume of the separator compared with the settling chamber. The drawback is the increasing pressure drop. Further information is available in the "Waste water and waste gas treatment BREF" [217, EC, 2003].

Achieved environmental benefits

Reduction of air emission pollutants. Potential re-use of airborne materials.

Cross-media effects

Energy consumption.

Operational data

Separators are characterised by a simple and robust design, small space requirements and high operating reliability.

Deflection or inertia separators enable effective dust removal. Due to their inertia, larger particles are unable to follow the repeatedly deflected gas stream and are separated. With the appropriate design, it is possible to achieve separation rates of 50 % for particles in excess of $100\ \mu\text{m}$.

Applicability

Separators are suitable for use where:

- there are high levels of dust in the untreated gas
- there is no great requirement for the removal of fine particles
- there is a need for preliminary separation and/or protection and relief of downstream systems
- pressures are high, e.g. high pressure dedusting
- temperatures are high, e.g. high temperature dedusting.

Economics

Low cost technique.

Reference literature

[65, Germany, 2002]

4.4.3.5.2 Cyclones

Description

Cyclones use inertia to remove particles from the gas stream by using centrifugal forces, usually within a conical chamber. They operate by creating a double vortex inside the cyclone body. The incoming gas is forced into circular motion down the cyclone near the inner surface of the cyclone tube. At the bottom, the gas turns and spirals up through the centre of the tube and out of the top of the cyclone. Particles in the gas stream are forced toward the cyclone walls by the centrifugal force of the spinning gas but are opposed by the fluid drag force of the gas travelling through and out of the cyclone. Large particles reach the cyclone wall and are collected in a bottom hopper, whereas small particles leave the cyclone with the exiting gas. Further information is available in the “Waste water and waste gas treatment BREF” [217, EC, 2003].

Achieved environmental benefits

Reduction of air emission pollutants. Potential re-use of airborne materials.

Cross-media effects

Energy consumption.

Operational data

Cyclones are characterised by a simple and robust design, small space requirements and high operating reliability.

Cyclones achieve better separation results than separators (see Section 4.4.3.5.1). Table 4.31 shows performance data of a cyclone, compared to other separation techniques. Figure 4.24 shows the operational principle of a cyclone.

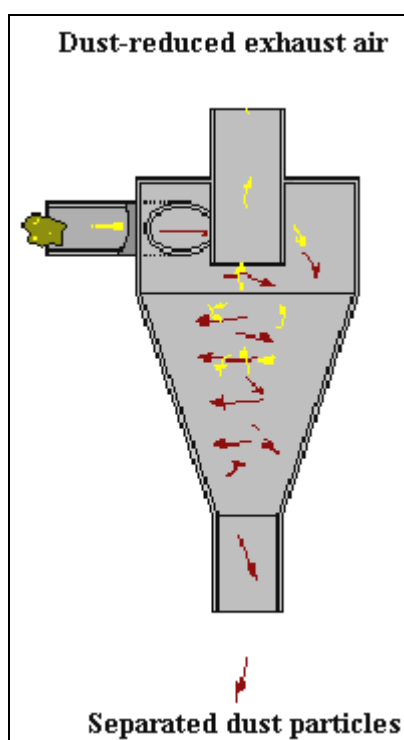

Figure 4.24: Operational principle of a cyclone

It is reported that cyclones are used to remove small particles in the exhaust air of the drier, during the production of distillers dried grains and the efficiency of the cyclones can reach up to 99.97 % (see Section 4.7.9.7.1) depending on process conditions and particle sizes.

Applicability

Cyclones are used to control particulate material of primarily $>10\ \mu\text{m}$. There are, however, high efficiency cyclones designed to be effective even for particles as small as $2.5\ \mu\text{m}$.

Cyclones used without other abatement techniques are generally not adequate to meet air pollution regulations, but they serve a purpose as precleaners for more expensive final control devices such as fabric filters (see Section 4.4.3.7) or ESPs (see Section 4.4.3.6). They are extensively used after spray drying operations and after crushing, grinding and calcining operations. Fossil fuel-fired industrial fuel combustion units commonly use multiple cyclones which operate with greater efficiency than a single cyclone and can separate particles $<2.5 \mu\text{m}$.

Cyclones are used for the removal of solid and liquid air pollutants. They are mainly used for separation of large particles only, i.e. $>10 \mu\text{m}$. They are suitable for use where:

- there are high levels of dust in the untreated gas
- there is no great requirement for the removal of fine particles
- there is a need for preliminary separation and/or protection and relief of downstream systems
- pressures are high, e.g. high pressure dedusting
- temperatures are high, e.g. high temperature dedusting.

Economics

Low cost technique.

Example plants

Cyclones are used during the production of animal feed; dried milk; dried soup; cake mixes; custard; distillers dried grains; dried sugar beet pulp; starch; ice-cream mixes; coffee roasting, drying and blending; tea blending and malt blending, generally, cyclones are used as an integral part of the process to recover dust from the extracted air for reprocessing. They are used in the vegetable oil sector to remove fine impurities such as plant residues, dust, sand and wet dust emissions from raw oilseeds (see Section 4.7.4.10).

Reference literature

[65, Germany, 2002, 179, Gergely, 2003]

4.4.3.5.3 Wet separation

Description

In dynamic separation techniques, the effective mass forces, i.e. gravity, inertia and centrifugal forces, all fall off sharply with increasing particle size. Wet cyclones are high efficiency units, spraying water into the waste gas stream to increase the weight of the particulate material and hence also removing fine material and increasing the separation efficiency. Although, generally speaking, this merely shifts the pollutants from the air into the water. Wet separators may be chosen for particular applications, e.g. when there is an explosion risk associated with a dust.

Different types of wet separators can be distinguished by classifying them in terms of their design features. Some examples are:

- absorption techniques such as scrubber towers, spray scrubbers, packed bed absorber (see Sections 4.4.3.7.3 – 4.4.3.8 and Table 4.33)
- injection scrubbers, e.g. high pressure/dual substance injection scrubbers
- jet scrubbers
- vortex scrubbers
- rotary scrubbers, disintegrators (high performance)
- venturi scrubbers (high performance).

Achieved environmental benefits

Reduction of air emissions, e.g. dust. Potential re-use of airborne materials. It can be advantageous if there is an in-plant opportunity to re-use the laden collecting liquid. Recovery of the product, e.g. in vegetable oil processing, the collected dust is recovered and can be added back to the meal. Prevention of fire risk.

Cross-media effects

Energy consumption. Waste water production.

Operational data

Using wet separation, it is possible to achieve separation rates of 80 – 99 %. When using cyclones, wet dust emission concentrations of $<50 \text{ mg/Nm}^3$ can be achieved. Table 4.31 shows current performance data of this technique, compared to other separation techniques.

Dust particles present in the untreated gas are brought into contact with, and become attached to, the considerably larger droplets of the collecting liquid and can then be removed together with the droplets. The relatively large dust-laden droplets, which have a diameter of 50 - 200 μm , are usually removed from the gas stream by means of cyclones or lamellar separators. Cyclones are used for heavy solids loads and small gas streams. Better separation rates and lower pressure losses are achieved by using lamellar separators in high performance separation units. These consist of vertically arranged metal or plastic plates. These can separate particles larger than 10 μm .

Waste water is produced. The dust-laden collecting liquid can be treated and returned to the process, or concentrated by evaporation. Drying plants, in particular, give off vapours laden with water vapour which may contain not only particulate pollutants, but also odours and gaseous pollutants. An example of design standards used in Germany according to DIN standards [230, Deutsches Institut für Normung p.v., 2005] is shown in Table 4.33.

Applicability

Wet separators are used for the removal of solid and liquid air pollutants, e.g.

- flammable or sticky dust
- where there is a risk of explosion
- for the simultaneous separation, or preliminary separation of solid, liquid and gaseous pollutants
- for small dust particles ($<0.1 \mu\text{m}$).

Scrubbers are used in the FDM sector, e.g. to treat VOCs, ffa and odours from vegetable oil refining.

Economics

The cost of waste water treatment may be considerable, in some cases even higher than for measures to control dust emissions.

Reference literature

[65, Germany, 2002]

Description	Scrubber tower Spray scrubber Packed bed absorber	Injection scrubber (high pressure or dual-substance injection scrubber)	Jet scrubber	Vortex scrubber	Rotary scrubber, disintegrator	Venturi scrubber
Symbols according to DIN 30600/28004						
Gas speed in contact zone in relation to free cross-section (m/s)*	1 – 5	20 – 60	5 – 15	8 – 20	25 – 70	40 – 150
Pressure difference over entire separator (bar)*	1 – 25	5 – 25	Pressure recovery of approximately 1 – 10	15 – 30	2 – 10 ⁽¹⁾	30 – 200
Energy requirements (kWh/1000 m ³)	0.2 – 3	0.4 – 2	1.2 – 3	1 – 2	4 – 15 ⁽¹⁾	5 – 15
Collecting liquid/gas ratio (l/m ³)*	1 – 5	0.5 – 5	5 – 50	No data possible due to process principle	1 – 3 per stage	0.5 – 5
Separation limit (µm)*	0.7 – 1.4	0.1 – 1	0.8 – 0.9	0.6 – 0.9	0.1 – 0.6	0.05 – 0.5
Separation rate (%) ⁽²⁾	50 – 85	90 – 95	90 – 95	90 – 95	92 – 96	96 – 98
* Approximate values, higher or lower variations are possible						
1) In disintegrators, the energy consumption is often considerably higher depending on the efficiency and the volume of gas handled. A pressure recovery of up to 25 bar is possible.						
2) The separation rate shown in the table merely gives a rough idea of the possible working range. Although the separation rate is easy to measure, it only permits limited conclusions about the efficiency of a separator. For example, it is directly dependent on the particle size distribution of the input material. If the particle size distribution changes, so does the separation rate, even if the other parameters remain constant. A knowledge of the separation rate does, however, become important in the specific application. The fraction separation rate is a much more suitable parameter for assessing the efficiency of a separator.						

Table 4.33: Dust removal from air – overview of wet separators

4.4.3.6 Electrostatic precipitators

Description

Electrostatic precipitators (ESPs), are used to separate solid or liquid particles from waste gases. The particles distributed in the gas are electrostatically charged so that they stick to collection plates.

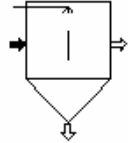
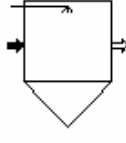
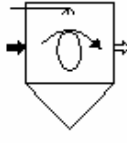
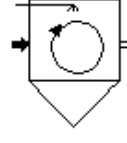
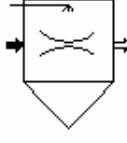
The main components of an ESP are the filter housing; discharge and collecting electrodes; power supply; gas guides or baffles and a rapping system for cleaning the collecting plates. The separation process can be divided into the following individual stages:

- charging of the particles in the ion field
- transport of the charged particles to the collecting plate
- collection and film formation on the collecting plate
- removal of the dust film from the collecting plate.

A distinction is made between dry and wet ESPs. These may have a horizontal or vertical gas flow. Dry ESPs are mostly built with collecting electrodes in plate form; they are also called plate ESPs. In wet ESPs, the collecting electrodes frequently take the form of tubes, here the gas flow is usually vertical; they are also called tube ESPs.

Achieved environmental benefits

Reduction of air emissions. Low energy requirements compared to other separation techniques.

Cross-media effects

Waste water produced, when wet ESPs are used.

Operational data

Electrostatic precipitators permit separation rates of up to 99.9 %, effective separation of particles even lower than 0.1 μm , and treatment of waste gas volumes higher than 1000000 m^3/h . Table 4.31 shows current performance data of this technique, compared to other separation techniques.

Electrostatic precipitators have comparatively low pressure losses, e.g. from 0.001 – 0.004 bar; low energy requirements, e.g. 0.05 to 2 kWh/1000 m^3 and a long service life. Wet ESPs can achieve better separation rates than dry ESPs. In particular, they can separate fine dusts, aerosols and to some extent, heavy metals and gaseous substances.

Figure 4.25 shows the typical arrangement of an electrostatic precipitator.

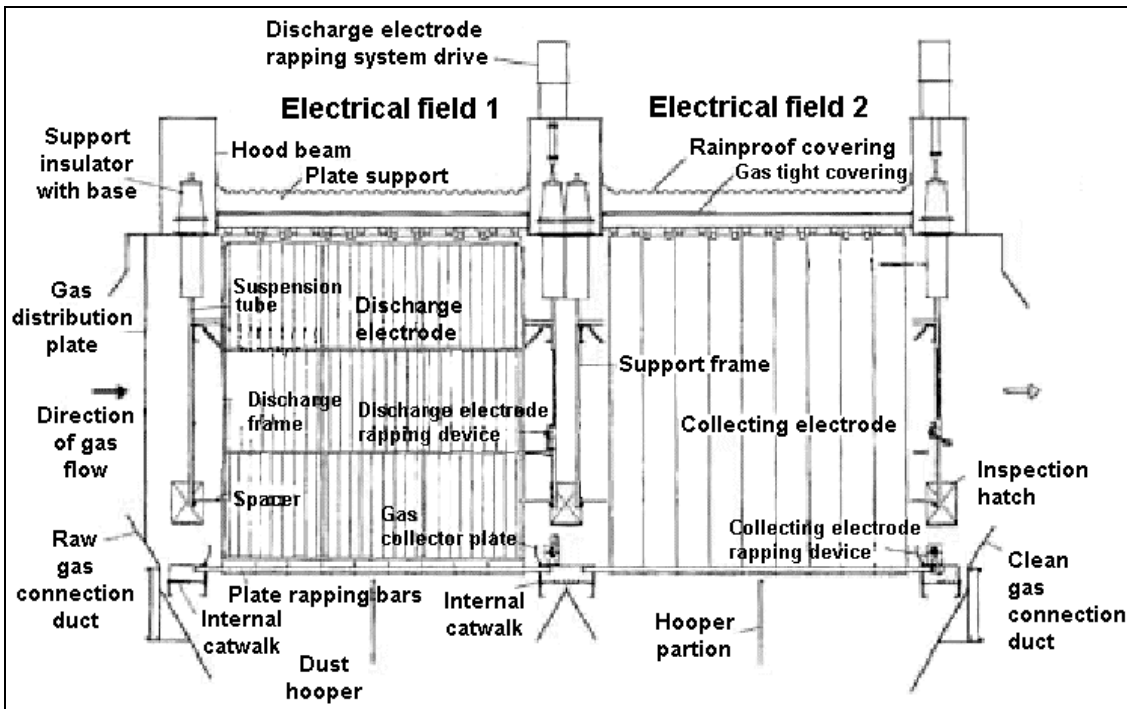

Figure 4.25: Typical arrangement of an electrostatic precipitator (only two zones shown)

Applicability

Used for the removal of solid and liquid air pollutants, especially for fine dust. ESPs are used in large systems for cleaning large quantities of waste gas at high temperatures. Wet ESPs are used for cleaning liquid-saturated gases, for acid and tar mists, or if there is a risk of explosion.

Reference literature

[65, Germany, 2002]

4.4.3.7 Filters

Filter separators are typically used as final separators, after preliminary separators are used, e.g. where the waste gas contains components with properties damaging to filters, e.g. abrasive dust or aggressive gases. This ensures adequate filter life and operating reliability.

In filter separators, the gas is fed through a porous medium in which the dispersed solid particles are held back as a result of various mechanisms. Filter separators can be classified on the basis of filter medium, performance range and filter cleaning facilities, as summarised in Figure 4.26.

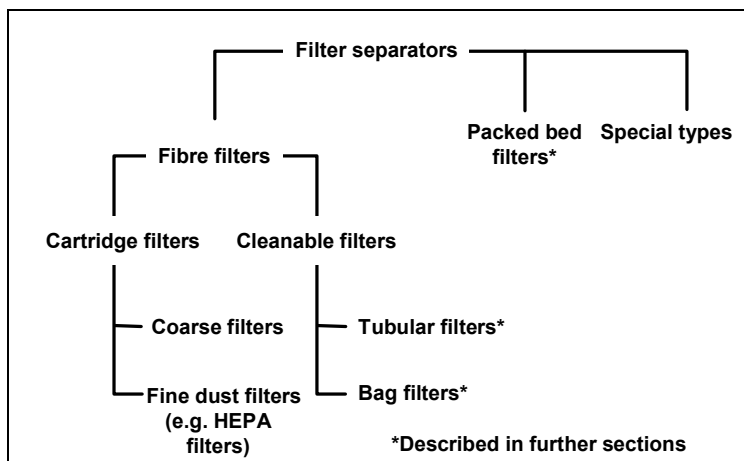

Figure 4.26: Types and classification of filters

In a fabric filter, waste gas is passed through a tightly woven or felted fabric, causing dust to be collected on the fabric by sieving or other mechanisms. Fabric filters can be in the form of sheets, cartridges or bags (the most common type) with a number of the individual fabric filter units housed together in a group. The dust cake that forms on the filter can significantly increase the collection efficiency.

Cleanable filters are among the most important types of filter separators used in industrial particulate removal. The practice of using a woven fabric filter material has largely changed to the use of non-woven and needle-felt materials. The most important parameters in cleanable filters are the air to cloth ratio and the pressure loss.

The filter material performs the actual separation and is the essential component of a filter separator. Woven fabrics have threads which cross at right angles. Non-wovens and needle-felts, by contrast, are flat three-dimensional structures that may be stabilised by the adhesion of the fibres or by alternating the insertion and removal of fibres. Non-wovens and needle-felts may also contain an internal supporting woven fabric, e.g. polyester or glass fibre fabric, to reinforce them. Needle-felts made of synthetic fibres are being increasingly used.

Non-wovens and needle-felts possess three-dimensional filtering characteristics. Dust particles are caught in the filter structure, forming an ancillary filter layer that ensures good separation of even the finest particles. One characteristic of this “deep filtration” is a large effective specific surface area. Regular intensive cleaning removes the accumulated dust layer and prevents excessive pressure losses. Problems, however, may be caused by sticky, fatty, agglomerating, adhesive, abrasive and/or hygroscopic dust particles.

4.4.3.7.1 Tubular filters

Description

In tubular filters, the filter medium consists of tubes up to 5 metres long with a diameter of between 12 and 20 cms. The gas flows from inside to outside or *vice versa*, depending on the cleaning method.

The equipment contains a round filter comprising a bank of vertical tubes mounted in a cylinder, similar in appearance to a cyclone and which does not require significant space. The airstream is passed through the filter and the fines are deposited on the surface of the individual tubular filters. The tubular filters are cleaned by means of a fully automatic pulse-like reverse flushing system, using compressed air or other pressurised gases, with the aid of a multistage injector system. The tubes are cleaned individually, which ensures continuous cleaning of the tubular filters and dust removal.

The product cleaned off the tubular filters falls onto the outlet base, where it is conveyed by air flowing through a special perforation system, to the dust outlet. The gases cleaned in this way leave the filter as clean gas via a clean gas chamber.

The individual cleaning of the tubular filters reduces the quantity of dust cleaned from the filter at any given time, which means the potentially explosive dust-air volume in the filter chamber is correspondingly smaller compared with conventional filter systems. CIP filters have been used successfully in the food industries since 1995. If used in the dairy industry, the filter product is comparable to the spray drier tower product. Tubular filters may be used without a preliminary cyclone separator.

The cleaning system for the round filters is similar to that used for cleaning the tubular filters installed as a CIP system. A stream of air is passed through the CIP nozzles in the base of the tubular filter and the other nozzles within the filter, during operation, but not during CIP cleaning. This prevents the CIP nozzles from being blocked with dust from the process air.

Another important advantage is that the tubular filter base in the zone where the airstream is laden with dust is kept clean by air flushing. This means that even with very hygroscopic products the base is kept free of heavy deposits. This is a substantial advantage compared with other filter designs and extends the operational time between cleaning phases. The clean gas and dirty gas zones, the tubular filters, the filter wall and the other internal parts are intensively sprayed via carefully arranged nozzle groups.

Figure 4.27 shows a tubular dust filter used to remove fines, downstream of a spray drier in a large dairy.

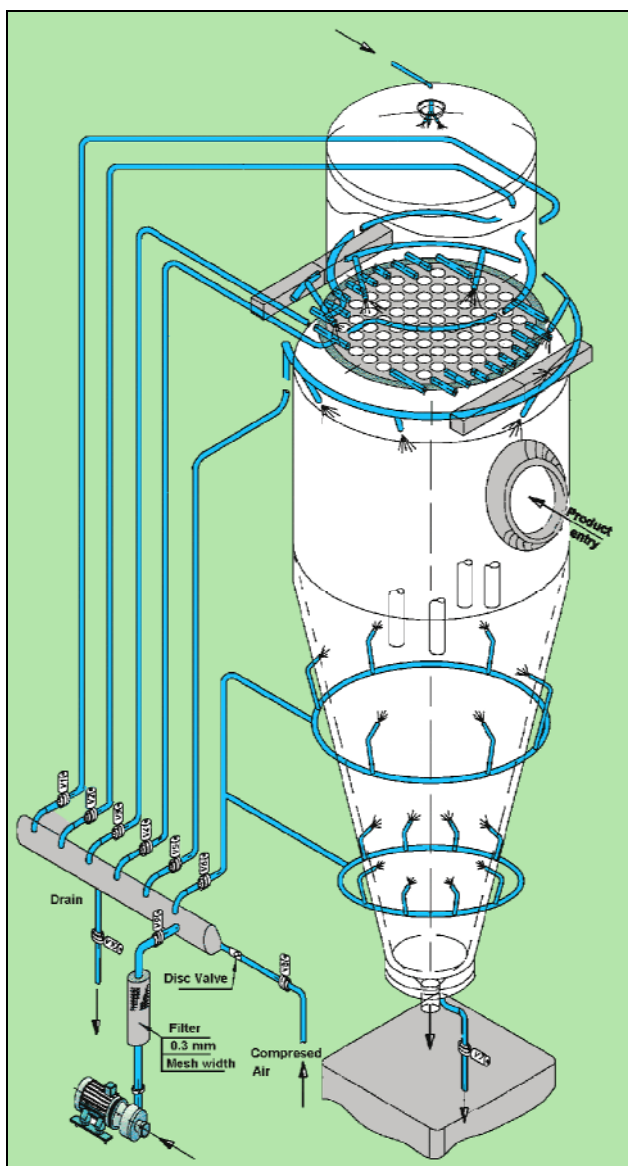

Figure 4.27: Tubular filter system of a large dairy

Achieved environmental benefits

Reduced emissions of dust to air. Reduced energy consumption is also reported (no data provided).

Reduced waste production, e.g. due to the separation process being dry, it may, in principle, be possible to re-use separated particulate matter in the process, or as a by-product.

Filters use significantly less energy than cyclones and produce less noise. If filtering installations suitable for CIP are used for outgoing air, it is not necessary to use cyclones allowing huge energy savings and noise reductions to be achieved. Reduced consumption of water and cleaning agents, by using CIP.

Operational data

Filter separators can achieve high separation rates, e.g. >99 %, with even very fine particles being separated very efficiently.

In the example dairy described in Section 4.7.5.8, dust emissions from the drying totalled 534 kg/yr dust after filtering, giving 28 mg dust/t dried product. It is also reported that an emission level of 10 mg/Nm³ is achievable. In the same dairy, it was specified that an interval of 3 to 4 minutes should be allowed between cleaning operations, to allow the water to drain from the pipes. It is important to ensure complete drainage, to prevent subsequent dripping at the nozzles. At the end of the entire cleaning programme, the relevant flaps and valves in the return line have to be left open to allow the water in the tubular filters to drain away. Drying of the system needs to be started about 1 to 2 hours after the end of the cleaning procedure. The tubular filters need to be dried with warm air, with the tubular filter cleaning system switched off, to prevent operational problems due to moisture when it is used again.

Applicability

Tubular filters are widely applied in the FDM sector. They are used for the removal of solid and liquid air pollutants.

Example plants

A milk powder manufacturer in Germany.

Reference literature

[9, Verband der Deutschen Milchwirtschaft (German Dairy Association), 1999, 65, Germany, 2002]

4.4.3.7.2 Bag filtersDescription

Bag filters are made up of filter material up to about 30 mm thick and measure up to 0.5 m high and 1.5 m long. The filter bags are fitted with their open end towards the clean gas duct. The untreated gas stream always flows from outside to inside, usually in the upper region of the filter bag. Table 4.34 shows a comparison between different bag filter systems and Figure 4.28 shows an industrial baghouse.

Parameter	Pulse jet filter	Membrane fibreglass filter	Fibreglass filter
Air to cloth ratio	22 – 25 m/s	19 – 25 m/s	8 – 10 m/s
Temperature limits	200 °C	280 °C	280 °C
Bag type	Polyester	Membrane/fibreglass	Fibreglass
Bag size	0.126 x 6.0 m	0.292 x 10 m	0.292 x 10 m
Cloth area per bag	2.0 m ²	9.0 m ²	9.0 m ²
Cage	Yes	No	No
Pressure drop	2.0 kPa	2.0 kPa	2.5 kPa
Bag life	Up to 30 months	6 – 10 years	6 – 10 years

Table 4.34: Comparison between different bag filter systems



Figure 4.28: Picture of an industrial baghouse

Achieved environmental benefits

Reduced emissions of dust to air. Reduced energy consumption is also reported (no data provided).

Reduced waste production, e.g. due to the separation process being dry, it may, in principle, be possible to re-use separated particulate matter in the process, or as a by-product.

Filters use significantly less energy than cyclones and produce less noise. If filtering installations suitable for CIP are used for outgoing air, it is not necessary to use cyclones allowing huge energy savings and noise reductions to be achieved. Reduced consumption of water and cleaning agents, by using CIP.

Operational data

Filter separators can achieve high separation rates, e.g. >99 %, with even very fine particles being separated very efficiently. Bag filters can be used to reduce dust emissions to <5 mg/Nm³.

As a general rule, the average distance between fibres is considerably larger than the particles to be collected. The separation rates due to the screen effect are also supplemented by mass forces, obstructive effects and electrostatic forces.

Applicability

Filters are used for the removal of solid and liquid air pollutants. They are also used for flue-gas purification.

Example plants

Bag filters are used in almost all the FDM sectors.

Reference literature

[65, Germany, 2002]

4.4.3.7.3 Packed bed filters

Description

The filter medium used in packed bed filters is typically a granular layer of gravel, sand, limestone or coke in the 0.3 to around 5 mm particle size range. During filtration, the dust particles become attached to the granulated layer. A dust layer which supports the separation process is formed at the surface of the bed. Penetration of the separated dust can be prevented by using fine particles (<0.5 mm) and low flow speeds (<0.1 m/s). However, there is a risk of bridge formation, which can result in reduced separation rates.

The packed bed may be up to several metres high. Cleaning is carried out by counterflow rinsing, mechanical shaking in conjunction with flushing air, or by movable nozzles while cleaning is taking place. Use of a multi-compartment filter design ensures continuous cleaning.

Achieved environmental benefits

Reduced emissions of dust to air. Reduced energy consumption is also reported (no data provided).

Filters use significantly less energy than cyclones and produce less noise. If filtering installations suitable for CIP are used for outgoing air, it is not necessary to use cyclones allowing huge energy savings and noise reductions to be achieved. There is reduced consumption of water and cleaning agents by using CIP.

Operational data

Filter separators can achieve high separation rates, e.g. >99 %, with even very fine particles being separated very efficiently. Clean gas figures of around 10 mg/Nm³ for dust have been achieved in trials using packed bed filters, with an average dust content of 18 g/Nm³ in the dirty gas and a mean particle size of 0.5 µm.

The separation rate of packed bed filters is not as good as that of fibre layer filters. Packed bed filters are, therefore, used for separating problematical dust particles or separation at higher waste gas temperatures. Packed bed filters are frequently used in conjunction with preliminary separators, e.g. cyclones.

As a general rule, the average distance between fibres is considerably larger than the particles to be collected. The separation rates due to the screen effect are also supplemented by mass forces, obstructive effects and electrostatic forces.

Applicability

Packed bed filters can be used to achieve the simultaneous separation of dust and gases. Packed bed filters satisfy an essential requirement for high temperature or hot gas dedusting, namely utilisation of the thermal energy of the cleaned gas streams at a high temperature level. Packed bed filters are suitable for the removal of dusts which are:

- hard and abrasive
- at temperatures of up to 1000 °C
- mixed with chemically aggressive gases
- combustible and where there is a risk of sparks
- mixed with mists
- mixed with some gaseous pollutants, e.g. SO₂, HCl and HF, when simultaneous separation can be achieved with suitable packing.

Reference literature

[65, Germany, 2002]

4.4.3.8 Absorption

The words “absorber” and “scrubber” are sometimes used simultaneously and this can cause confusion. Absorbers are generally used for trace gas removal and scrubbers for particulate abatement. This distinction is not always so rigid, as odour and gaseous components in the air may also be removed together with dust by using vapour condensation or wet scrubbing (see wet separators in Section 4.4.3.5.3).

The aim of absorption is to make the largest possible liquid surface available and provide a good countercurrent flow of gas and liquid. The absorption process relies on the preferential solubility of the polluting components present in the exhaust stream within the absorption medium. There are a number of different types of absorber design and many variations with removal efficiency performances on the contact between the gas and the liquid. Three types of absorbers are reported; packed bed absorber (see Section 4.4.3.8.1), plate absorber (see Section 4.4.3.8.2), and spray scrubber (see Section 4.4.3.8.3).

Principle of operation

The process involves a mass transfer between a soluble gas and a liquid solvent in a gas-liquid contacting device. The rate at which a substance is removed from an airstream depends upon its degree of saturation at the solvent surface within the absorber, which in turn depends upon its solubility and its rate of removal from the circulating solvent by reaction and bleed-off. This rate mechanism determines the efficiency of removal for a particular size of absorption plant and a particular air flowrate. Thus, the efficiency of removal depends on the reaction time, the degree of saturation at the surface of the liquor and the reactivity of the gas components within the absorbing solvent.

Providing the airborne components to be removed are reasonably soluble in water, then an absorber can be designed to achieve a desired removal efficiency. The problem arises in the need to maintain a low enough concentration within the absorbing liquor at the surface to maintain the driving force for dissolution. This often results in excessive volumes of water being needed to achieve a reasonable efficiency. It is, therefore, generally impractical to remove different components effectively using water alone and other absorbents are typically employed.

Water only systems can, however, be considered as a first stage before other absorbers, but much of their effectiveness is due to mechanisms other than absorption. For example, water absorption of a non-saturated airstream will result in a cooling of the airstream to saturation via the process of adiabatic cooling. This cooling effect can lead to a condensation and the removal of components from the airstream as they cool to a temperature below their boiling point.

Design considerations

Effective liquid and air distribution are fundamental requirements in all absorber designs. Optimal design according to standard chemical engineering principles, requires data on concentration, solubility and mass transfer for the components to be removed from the gas stream. Most air emissions from the FDM sector are complex mixtures for which it is difficult to ascertain all the chemical species present and even more difficult to determine their concentrations. The nature and kinetics of the oxidation reactions are generally not known and these are very difficult to determine even for individual compounds. It is claimed that the design of absorption equipment must be empirical rather than scientific. Thus, the volume of packing is chosen according to the volume previously found to give reasonably complete absorption of those compounds that can be absorbed. If there is only limited operational experience with the discharge in question, then pilot plant trials can be undertaken.

Pilot plant trials or previous experience can, therefore, be used to determine the height of the packing required to achieve a given performance. The packing is chosen to allow the required number of unit height for the required efficiency. The packing size and type, the linear gas velocity, which determines the absorber diameter, the linear liquid velocity, the gas pressure drop and the absorber efficiency per unit height, which determines the packed height, are all interrelated. The design procedure, therefore, looks towards optimising the design in terms of capital and operating costs, taking into consideration the required volumetric throughput, absorption efficiency and constraints such as possible clogging of the packing and the maximum allowable pressure drop.

Typical ranges of the parameters detailed above are shown in Table 4.35.

Design Parameter	Units	Value
Gas velocity	m/s	0.5 – 2.0
Gas flowrate	kg/m ² /hr	2500 – 5000
Liquid flowrate	kg/m ² /hr	25000 – 50000
Gas residence time	sec	1 – 3
Pressure drop	mm/metre	20 – 50
Liquid bleed rate	% of recycle flow	0 – 10
Flooding	% of flooding	40 – 60

Table 4.35: Typical absorber design guidelines

Absorbing reagents

The efficiency of absorption can be increased if the absorbing liquid contains a reagent which reacts with the components present in the airstream. This effectively reduces the concentration of the airborne components at the liquid surface and thereby maintains the driving force for absorption without the need for vast amounts of absorbing liquid. There are a number of specific reagents that can be employed within absorption systems to remove malodorous and other organic components from an airstream. These reagents are generally oxidising solutions.

The most widely applied agents include sodium hypochlorite, hydrogen peroxide, ozone and potassium permanganate. The use of acids and alkalis as absorbing mediums is also fairly widespread and often the acid/alkali system is employed in conjunction with an oxidising absorbent. Due to the considerable number of components that can be present in the air emissions from a food processing installation, multistage absorbers are often used. Thus, an absorbing system could comprise an initial water scrubber followed by an acid or alkali stage and finally an oxidising stage.

Sodium hypochlorite is a very widely applied oxidising agent, primarily due to its high reactivity. Hypochlorite has been found to be particularly useful in installations with emissions containing significant levels of sulphur and nitrogen based malodorous compounds.

Hypochlorite is generally used at an alkaline pH to prevent dissociation into free chlorine. There is a tendency for the hypochlorite to react with certain components via a chlorination rather than an oxidation reaction. This is a particular concern where an airstream contains aromatic material which could generate chlorinated aromatic compounds in the treated gas stream. The chlorination potential is greater at higher hypochlorite concentrations, so a design incorporating lower hypochlorite concentrations in the absorbing liquor than is actually required for optimal absorption reduces the risk of this occurring.

To address this a new process was developed which is essentially a conventional hypochlorite absorber, but with a catalyst incorporated into the liquid recycling system. The catalyst is based on nickel oxide and the system is claimed to dramatically increase the hypochlorite reaction rate and prevent any chlorination reactions. The potential chlorination reaction is avoided as the catalyst promotes the decomposition of the hypochlorite into gaseous oxygen and sodium chloride as opposed to free chlorine. This in turn, allows the use of increased hypochlorite concentrations in the absorber and improved efficiency. The pH is controlled to approximately pH 9 and the redox potential is controlled to an optimised voltage.

Hydrogen peroxide is generally less effective than hypochlorite, due to its lower oxidising power. It does, however, have the advantage that its reaction product is water and can be used for applications where aromatics are present, for reasons mentioned above. Hydrogen peroxide is usually used under acidified conditions, primarily to control its rate of decomposition.

Ozone is also a powerful oxidising agent, although its oxidative power is more pronounced in the liquid phase than in the gas phase. A recent application that incorporates ultraviolet light to enhance the oxidative performance of ozone is discussed further in Section 6.1.

A number of surfactant-based absorbing solutions have been used in recent years, although there is limited information available on their performance. In particular, a non-ionic based surfactant system with reduced foaming, such as the material used for dishwasher rinse-aids, has been employed successfully.

Solid oxidising agents are also used, e.g. a calcium oxide scrubber, where particulate calcium oxide is put into contact with the malodorous gas stream producing a solid residue of calcium carbonate. A limited odour removal performance and severe operational problems in terms of solids handling are reported. It is, therefore, more common for only liquid absorbing agents to be used.

4.4.3.8.1 Packed bed absorber

Description

Packed bed systems are the most commonly used type of absorbers, offering the advantages of maximised surface area per unit volume and relatively low pressure drop. A packed bed absorber system layout is shown in Figure 4.29.

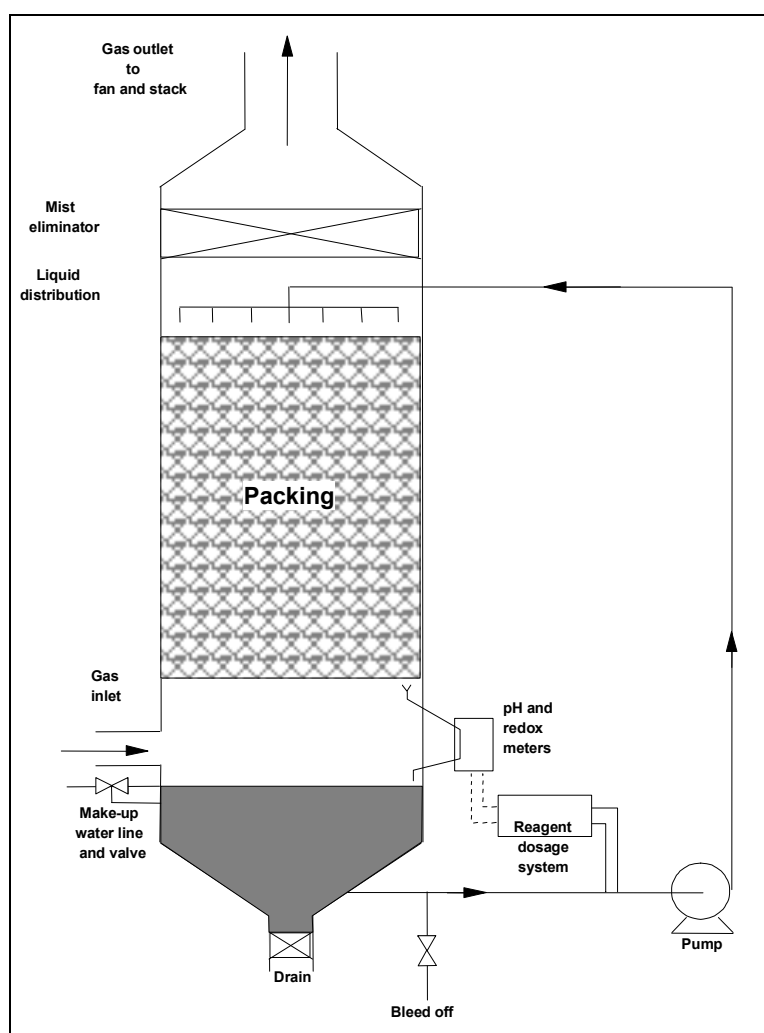

Figure 4.29: Packed bed reactor layout

The airstream to be treated is directed in a countercurrent fashion to the recirculated liquid stream. The packed bed area comprises a large number of packing pieces, usually made of plastic, which allow a considerable surface area for the gas and liquid to come into contact with each other. The liquid system can comprise anything from a simple recirculation pump assembly to a sophisticated chemical dosing station together with pH control dosing/control facilities. The liquid distribution is reported to be most effectively achieved by a series of nozzles situated symmetrically over the surface area of the unit. The treated airstream is discharged through a mist eliminator to remove any entrained droplets prior to discharge.

Achieved environmental benefits

Removal of odours, gases and dust from air.

Cross-media effects

Waste water is generated. Likely to generate a visible plume at the flue-gas outlet.

Operational data

Absorbers are reported to be more effective for the removal of specific components rather than overall removal and they have a reported efficiency of typically 70 – 80 %.

The use of one central nozzle to distribute the liquid is decreasing because it gives poorer liquid distribution. Depending upon the vertical length of the packing within the absorber, there may be a need to incorporate liquid redistribution systems.

The equipment is compact, so absorbers do not take up much space, but they may require space for the safe storage of chemicals.

Applicability

In general terms, absorbers are suitable for a wide range of volumetric airflows which contain gases and/or odours in relatively low concentrations.

Economics

Relatively inexpensive, compared to other end-of-pipe odour control techniques. Relatively low capital and operating costs. Their cost effectiveness is reduced if the exhaust gas to be treated has a high moisture content, due to their preferential absorption of water vapour.

Example plants

Used extensively to control odour.

Reference literature

[34, Willey A R and Williams D A, 2001]

4.4.3.8.2 Plate absorber

Description

Plate absorbers consist of a vertical tower with several horizontal perforated trays or sieve plates stacked in it. Baffles are situated a short distance above the apertures in the plates. Scrubbing liquid enters the top of the tower and successively flows along each of the trays. The airstream to be treated enters the bottom of the tower and flows upwards, passing through perforations in the plates. The velocity of the airstream is sufficient to prevent liquid seeping through the perforations. The airstream to be treated is directed through the falling curtains of liquid overflowing the trays. There are many variations in the plate design and positioning of the liquid nozzles. The plate absorber system is shown in Figure 4.30.

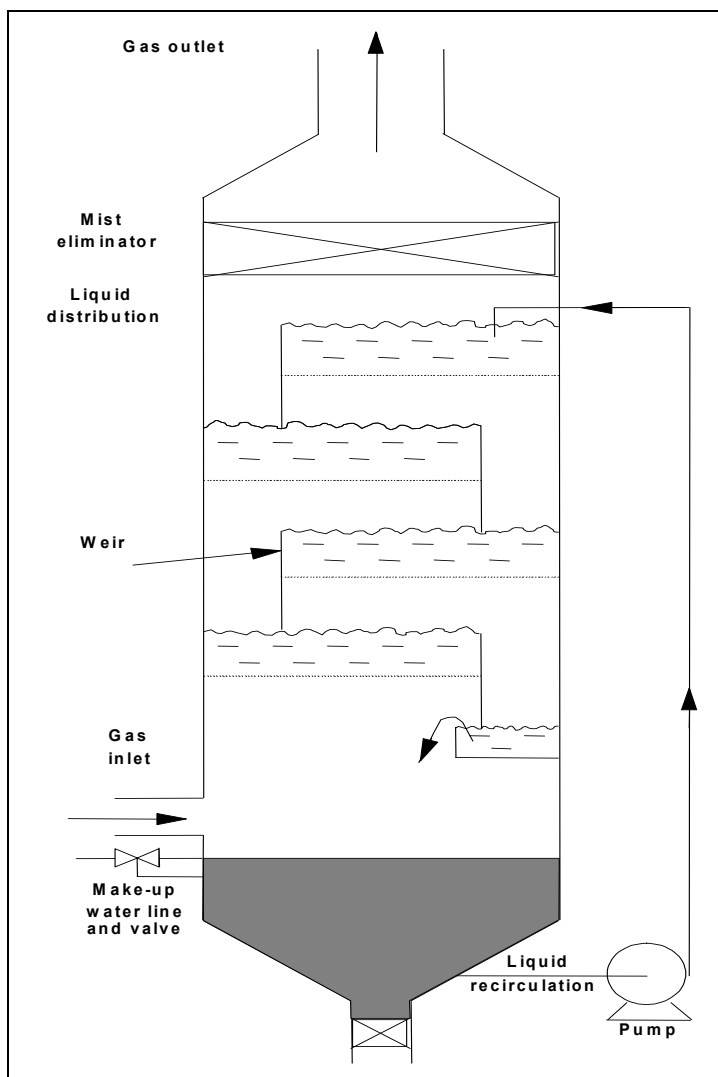

Figure 4.30: Plate absorber layout

Achieved environmental benefits

Removal of odours, gaseous components and dust from air.

Cross-media effects

Waste water is generated. Likely to generate a visible plume at the flue-gas outlet.

Operational data

Absorbers, in general, are reported to have the advantage of having a relatively low pressure drop. They are reported to be more effective for the removal of specific components rather than overall removal and they have a reported efficiency of typically 70 – 80 %.

The equipment is compact, so absorbers do not take up much space, but they may require space for the safe storage of chemicals.

Applicability

In general terms, absorbers are suitable for a wide range of volumetric airflows which contain gases and/or odours in relatively low concentrations.

Economics

Relatively inexpensive, compared to other end-of-pipe odour control techniques. Relatively low capital and operating costs. Their cost-effectiveness is reduced, if the exhaust gas to be treated has a high moisture content, due to their preferential absorption of water vapour.

Example plants

Applied in the FDM sector.

Reference literature

[34, Willey A R and Williams D A, 2001]

4.4.3.8.3 Spray scrubberDescription

A spray scrubber simply comprises a liquid spray which comes into contact with an upward rising airstream within a vessel. The vessel contains no packing or plates or any device used to enhance gas-liquid contact. A typical spray tower configuration is shown in Figure 4.31.

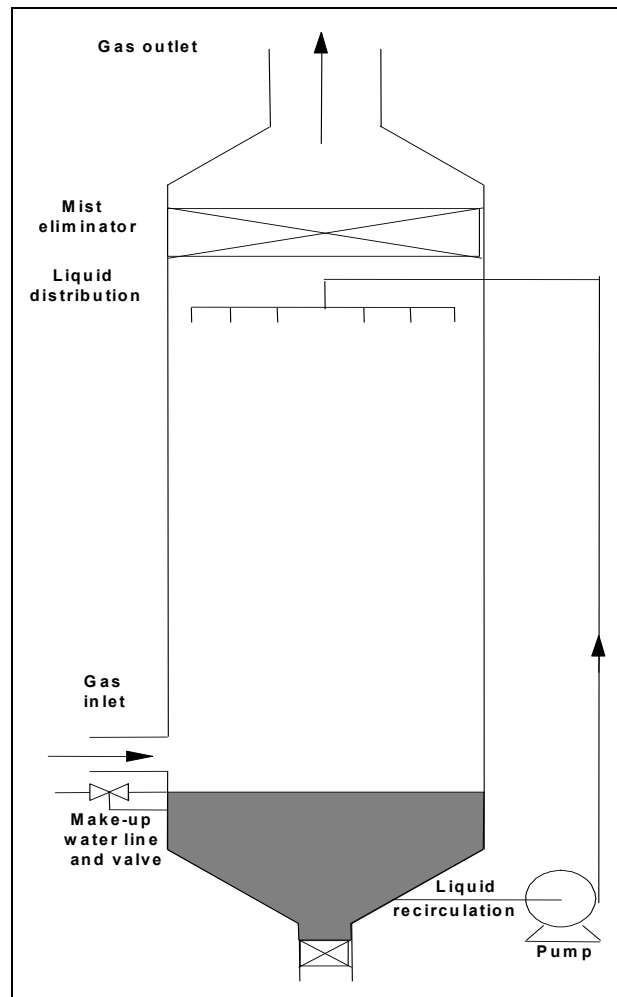

Figure 4.31: Spray chamber layout

Achieved environmental benefits

Removal of condensable vapours and dust from air.

Cross-media effects

Waste water is generated. Likely to generate a visible plume at the flue-gas outlet.

Operational data

The equipment is compact, so it does not take up much space, but it may require space for the safe storage of chemicals.

Where the presence of dust or condensables is a potential problem and gaseous pollution or odour removal is required in the same piece of equipment, this can give rise to considerable operational problems and downtime whilst the absorber is cleaned and put back into action. In this respect, it may be suitable to install a wave plate absorber. Here, the airstream entering the unit is forced through a series of wave bank plates, with a liquid spray positioned in front of each wave plate assembly. The wave plate assembly can be designed to be removed *in situ*, cleaned and replaced into the unit without the need to switch off the plant.

Applicability

A spray chamber is not generally suitable for the control of odour or gaseous substances, due to the limitations in mass transfer. However, where the airstream to be treated contains a significant level of dust or condensable material, then a simple spray tower may be used to remove these, prior to treatment with an increased gas-liquid contact, such as a plate or packed bed absorber.

Economics

Relatively low capital and operating costs.

Reference literature

[34, Willey A R and Williams D A, 2001]

4.4.3.9 Carbon adsorption

Description

Adsorption is a unit process involving the capture of airborne components onto a fine particulate active surface. There are a number of possible active materials that are used for general applications, including zeolites, silicas, polymeric resins and activated carbon. Currently, activated carbon is the most frequently chosen absorbent within the FDM sector and hence the terminology “carbon adsorption” is commonly used.

Carbon adsorption is a dynamic process in which vapour molecules impinge on the surface of the solid and remain there for a period of time before desorbing again into the vapour phase. An equilibrium is established between adsorption and desorption, i.e. a particular concentration of a compound on the carbon surface corresponds to a concentration or partial pressure of that compound in the gas phase.

The adsorption process can be either physical, in which case the adsorbed molecules are held to the surface by Van der Waals forces, or chemical, where chemical bonds are formed between the adsorbed molecules and the surface. Both of these processes release heat, the latter rather more than the former.

Activated carbon can be made from a variety of carbonaceous materials, including wood, coal, peat, nut shells, lignite, bone and petroleum residues. Shell and coal based products are usually used in vapour phase applications. The manufacturing process consists of the dehydration and carbonisation of the raw material, which drives off the volatile matter and produces a rudimentary pore structure. This is followed by thermal or chemical activation.

Activated carbon used in odour control applications has the typical properties shown in Table 4.36.

Parameter	Units	Property
Particle size	mm	1.4 – 2.0
Bulk density	kg/m ³	400 – 500
Surface area	m ² /g	750 – 1500
Pore volume	cm ³ /g	0.8 – 1.2

Table 4.36: Properties of activated carbon

Carbon beds can either be once used and disposed of, or regenerated. Regenerative systems are typically used in installations where the recovery of the material being captured is economically attractive. It is more common to use a single fixed bed adsorber system. Regenerative systems are usually designed with multiple beds so that adsorption and desorption can be conducted simultaneously. It is usually necessary to raise the temperature of the adsorbent bed to release the adsorbate, with steam being the most commonly used medium. A regenerative system, therefore requires an additional capture mechanism for materials desorbed during the regenerative process.

The fixed bed system comprises a bed of activated carbon through which the gas stream to be treated is passed. The carbon is in either a simple packed bed arrangement or in the form of carbon filters. The filters are essentially paper or cardboard cartridges containing powdered activated carbon. In general, the cartridge arrangement is used for general room ventilation whilst the packed bed system is used for odour control from process exhausts. Once the activated carbon has expired, e.g. as judged by an increased outlet odour level, the carbon or cartridge arrangement needs to be replaced. The packed bed system has the advantage that, in most cases, it can be returned to the supplier for regeneration at his premises whilst the cartridge filters are usually disposed of by the user.

The design basis for room ventilation using cartridge filters is significantly different from that for process odour control using packed beds. In general, cartridge filters are employed for small vent flows of intermittent or infrequent nature with very low sorbent concentration. Conversely, the packed bed system is used where the concentration of components in the airstream to be treated is significantly higher than typical room or factory floor concentrations. The major difference in the design basis of each system is the residence time; with room ventilation requiring only 0.1 to 0.2 seconds, and process exhaust treatment requiring between 1 and 3 seconds. The choice of residence time is essentially a compromise between the physical volume of the designed bed and the time between renewals.

Table 4.37 shows the principles of operation of the three major types of adsorbers.

Adsorber	Principle of operation
Fixed bed unsteady state adsorber	The contaminated gas passes through a stationary bed of adsorbent
Fluidised bed adsorber	The contaminated gas passes through a suspension of adsorbent
Continuous moving bed adsorber	The adsorbent falls by gravity through the rising stream of gas

Table 4.37: Principle of operation of the main types of adsorbers

Achieved environmental benefits

Removal of odours, gases and dust from air.

Cross-media effects

Energy consumption. Waste is produced, e.g. when the activated carbon needs to be disposed of.

Operational data

The installation of a carbon adsorption system is fairly simple, comprising a fan and vessel to hold the carbon bed. Carbon adsorption can give odour removal efficiencies of 80 – 99 %.

The absorptive capacity of activated carbon is expressed as weight-% in terms of the amount of the specified material that can be adsorbed per unit mass of carbon. These figures vary considerably from as low as zero to as high as 110 % and are fairly meaningless for a malodorous exhaust potentially containing a wide variety of individual components. In this sense, as a general guideline, a value of 30 % can be used to estimate the expected lifetime of a carbon bed used in the FDM sector.

The expected life of the carbon bed can then be estimated based on a knowledge of the design residence time, the organic load and the airflow to be treated. This is illustrated in the following example. First, the organic load is calculated by the following equation:

$$\text{Load} = \text{airflow} \times \text{concentration}$$

Considering an airflow of 10000 m³/h with an organic concentration of 50 mg carbon/m³ and a carbon bed designed with a residence time of 1 second, then the organic load is 0.5 kg/h. A residence time of 1 second implies a carbon bed volume of 2.78 m³. Based on a carbon bulk density of 500 kg/m³, the carbon would be able to adsorb 30 % of 1390 kg which is equivalent to 2780 hours of operation. Thus, the bed would require replacement at a frequency of approximately three times per year.

Applicability

Carbon adsorption is generally suitable for low air throughputs of less than 10000 m³/h and where the contaminant to be removed is present in a low concentration of, e.g. less than 50 mg/Nm³. In terms of odour control, the major applications of carbon adsorption are the cleaning of ventilated air and the treatment of malodorous process emissions.

The presence of dust in the gas stream to be treated can seriously interfere with the efficiency of a carbon bed, as well as increase the operating pressure drop. Carbon adsorption is, therefore, not applicable where dust or even condensable material is present. The dust and condensables can be removed in a pre-filter arrangement, although this will add to the complexity and cost of the unit as well as adding operational problems in cleaning requirements and dust breakthrough.

In general, the lower the temperature, the greater the amount adsorbed and, therefore, the longer the penetration time or bed life. As a guideline, carbon adsorption is not applicable at a temperature above 40 °C. Furthermore, the efficiency of activated carbon is reduced at a relative humidity above 75 %, except for water soluble compounds such as the lower amines and hydrogen sulphide. This preferential adsorbance of water can lead to condensation within the bed, so making the carbon inactive. The bed would then require drying out before it could be re-used.

Economics

This technique has relatively low capital costs. The operational cost is high, e.g. carbon costs approximately EUR 2400/t. Regeneration is not normally economical, so the carbon bed has to be totally renewed when its adsorption efficiency begins to fall, which might be after only a short period of time depending on the odour emission rate and odorant concentration.

Reference literature

[34, Willey A R and Williams D A, 2001]

4.4.3.10 Biological treatment

The process of using micro-organisms to breakdown airborne odour emissions is used extensively. The reaction speed of the biodegradation process is relatively low, and optimising operating conditions can have a crucial influence.

There are two types of biological treatment, biofilters (see Section 4.4.3.10.1) and bioscrubbers (see Section 4.4.3.10.2). The most popular type of biological treatment is the biofilter.

There are a number of design considerations which need to be taken into account to ensure effective operation; these are residence time, temperature, humidity, effects of dust and fat on the filter, organic/odour load, and design and characteristics of the filter material.

Advantages and disadvantages of biological treatment methods are shown in Table 4.38.

Advantages	Disadvantages
Relatively low capital cost	Restricted to wet bulb temperatures <40 °C
Relatively low operating costs	High land area requirements
Potentially high odour removal ~ 90 – 99 %	Potential for visible plume formation
Simple design and operation	Requires control of pH and water content
	Slow adaptation to fluctuating concentrations

Table 4.38: Advantages and disadvantages of biological treatment
[34, Willey A R and Williams D A, 2001]

Principle of operation

The biofilm is the water layer prevailing around individual particles of the filter material where micro-organisms are present. When the airstream to be treated flows around the particles, there is a continuous mass transfer between the gas phase and the biolayer. Volatile components present in the exhaust gas, together with oxygen, are partially dissolved in the liquid phase of the biolayer. The second reaction step is the aerobic biological degradation of the components in the liquid phase. In this way, a concentration gradient is created in the biolayer which maintains a continuous mass flow of the components from the gas to the wet biolayer.

Transport across the phase boundary and diffusion into the biolayer provide food for the micro-organisms living in the biolayer. Nutrients, required for cell growth, are provided from the filter material.

4.4.3.10.1 Biofilter

Description

In biofilters, the pollutants are absorbed onto the filter material and degraded by the micro-organisms located on a fixed filter medium. The filter material is arranged in the form of a packed bed and is permeated by the waste gases. For waste gases with high dust levels, the gas needs to be passed through a dust remover, before the biofilter.

Biofilters can be operated in either downflow or upflow fashion. The relative merits of each mode are uncertain and it is most likely that operational efficiency is the same in each case. The pressure drop over a biofilter is low, typically in the range of 10 to 25 mm/m of packed height. This low pressure drop infers that proper design of the air distribution for either downflow or upflow installations is a critical design parameter. A typical layout of a biofilter is illustrated in Figure 4.32.

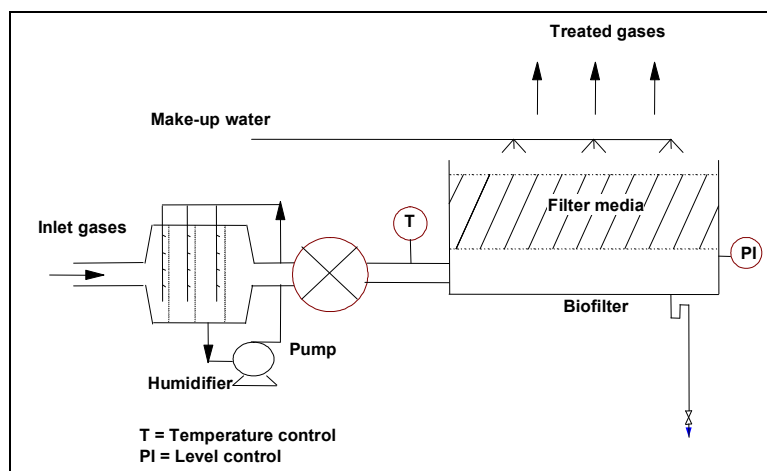

Figure 4.32: Biofilter layout

The waste gas to be treated is directed initially into a humidifier, where it is countercurrently put into contact with recirculating water. The air exiting the humidifier is subsequently directed to the biofilter.

It is not normal practice to operate the humidifier with a continuous fresh supply of make-up water as this would lead to a waste water discharge requirement.

Periodic irrigation of the top of the bed allows the system to maintain the required moisture content in the filter material of 40 – 60 %. Any water falling through the bed, via irrigation or rainfall, can be recycled to the humidifier to avoid a waste water discharge from the system.

There is a wide variety of filter materials that have been used in biofilters. The major requisites of the filter material are a high specific surface area, e.g. 300 – 1000 m²/m³, a high water bearing capacity, limited compaction characteristics and a limited resistance to flow. Traditionally, fibrous peat mixed with heather in a 50 % proportion has been used. The microbial activity occurs within the peat whilst the heather provides a stiffening agent to prevent compaction, thereby extending the operating life of the bed.

A variation of the peat/heather mixture is mushroom compost mixed with 5 mm diameter polystyrene spheres for support, in a 50 % proportion. Rootwood is typically comprised of tree roots, branches and loose twigs. The rootwood is split into lengths of typically 15 cm by a tearing apart action rather than straight cuts. This action effectively exposes the maximum surface area and does not require supporting material. These filter media have all been proven in full scale installations. Specific operating experience may be sought if any other materials are proposed.

Biofilters can be further subdivided into soil and non-soil based biofilters. The soil based biofilter or soil bed, comprises a layer of porous soil under which is a network of pipes through which the airstream to be treated is passed. An open structured soil is required to keep the pressure drop across the bed to a minimum.

Achieved environmental benefits

Reduced air emissions, e.g. odour/VOCs.

Cross-media effects

Generation of acidic by-products, e.g. from the biodegradation of exhaust gas components. Disposal of the filter material. In some cases, used material is composted to reduce the organic pollution and then sent for landspreading. Condensation water is recycled, otherwise it requires treatment.

Operational data

A correctly operating biofilter will exhibit an outlet odour concentration of typically 150 to 200 OU/m³. The characteristic smell associated with the treated discharge is a musty, moist forest type with very little resemblance to the inlet odour. Odour removal efficiencies of up to 99.5 % can be achieved, although the percentage removal is very dependent upon the inlet concentration. It is unlikely that an outlet odour level of less than 150 OU/m³ can be achieved so an inlet odour level of 5000 OU/m³ would represent a maximum efficiency of 97 %.

In general, the residence time required for a biofilter depends upon the level and type of contaminants present in the airstream to be treated. Components that are aromatic in nature will require a longer residence time than more simple organic chemicals. As a general guideline, a minimum residence time of 20 seconds is chosen, extended up to 40 seconds where contaminants with reduced biological degradability are present.

The velocity through the filter bed is typically between 0.02 and 0.05 m/s. The surface loading rate, which is often used to characterise a design, is typically within the range of 100 to 250 m³ gas/m² filter area/h.

A typical lifetime of a filter bed of 3 to 5 years is often quoted, however, for most filter materials, and particularly for peat/heather, the bed will require topping up within the first 18 months of operation.

Due to reasons of potential compaction, the maximum height of the filter media is restricted to approximately 1.0 to 1.5 metres. Where a greater height is required due to limited land availability. Then some form of intermediate support would be required within the vertical cross-section of the bed.

The distribution of air through the biofilter is an important consideration and a plenum chamber design is recommended. In this respect, the vertical height of the plenum chamber is at least 50 % that of the height of the filter material.

The pH of the filter material in a biofilter is typically maintained between 6.5 and 7.5, a range preferred by most bacteria. In some cases, the biodegradation of exhaust gas components can generate acidic by-products so dosing with alkali may be undertaken.

Important characteristics of the filter material include a low pressure loss, a high buffering capacity and a wide spectrum of micro-organisms present. Approximately 40 to 60 % moisture content of the filter bed is needed to ensure good efficiency. The filter bed needs regular maintenance, e.g. to be kept free of plant growth, settled material and gas breakthroughs, to ensure its optimal effectiveness.

A complete replacement of the material is only necessary if the degradation of the organic matter has proceeded to such an extent that the required air flowrate can no longer be achieved. To enable replacement of the filter material, the equipment has to be designed and constructed such that the grid is accessible for vehicles or the filter can be maintained with a mobile gripper. If the biofilter is divided into several segments, the entire production does not need to shut down for maintenance work.

Depending on the nature of the upstream process, an emergency gas vent to the air can be installed linked to a temperature sensor located at the inlet to the biofilter. The control mechanism is set such that if the biofilter inlet temperature exceeds 45 °C over a predetermined period of time, say 4 hours, the exhaust gases are discharged directly to the air thereby bypassing the biofilter. The use of such a system will mean that the waste gases are emitted untreated, so the conditions leading to such a bypass need to be prevented. Local temperature and bed pressure drop indicators are also recommended.

Dust and fats may need to be removed upstream of the filter to avoid potential clogging, leading to a rise in filter pressure drop and a reduction in operational efficiency.

Soil beds are normally constructed below ground, so care needs to be taken to ensure that the base of the soil filter is above the water table. The major disadvantage with the soil biofilter is the excessive residence time required for the biological process, which is in the region of 5 minutes. This results in very large open structures requiring significant land area.

Applicability

Used to eliminate biodegradable gaseous air pollutants, especially organic pollutants and odours, e.g. in the fish sector, coffee processing and WWTPs. Other areas of application are the purification of room and process air in beer yeast drying and in oil mills; cleaning of roasting gases in cocoa production and cleaning of cooling air in animal feed production.

The biofiltration process is suitable for a wide range of airflows, up to and exceeding 100000 m³/h, providing there is sufficient land space available. A limit to the maximum concentration of contaminants in the inlet airstream is generally documented as less than 5000 mg/Nm³, although a concentration limit of 1000 mg/Nm³ may be used as a guideline when assessing the suitability of biofiltration.

As exhaust gases from industrial sources generally contain a variety of components, pilot plant testing is recommended to ensure that the biofilter is adequately sized.

Biofilters are suitable for ventilation systems where a constant airflow is extracted from a vessel or process room. Periodic heavily contaminated airstreams are avoided unless there is a sufficient dilution from other sources being treated.

This technique is not applicable for airborne temperatures in excess of 40 °C. If temperatures above 40 °C are prevalent for significant periods of time, i.e. greater than 4 hours, then the micro-organisms present in the filter become sterilised and the bed requires reseeded. At temperatures below 10 °C, the rate of biological degradation falls dramatically. This technique is not applicable for humidities lower than 95 %.

It is reported that the use of biofilters in FDM installations producing ready-meals and ice-cream may increase hygiene risks, due to the bacterial population in the filter material.

Economics

Relatively high odour removal efficiency at relatively low cost compared with alternative treatment techniques. The capital cost of the downflow system is higher than for the upflow system as it will require an airtight top seal. This would be emphasised for a larger biofilter.

The specific investment costs for biofilters of modular construction, depend on the size of the plant and the construction standard. For smaller plants, i.e. 200 – 500 m³/h, the cost is about EUR 45 – 50/m³ of exhaust air. In larger plants, costs may go down to EUR 10 – 15/m³. These costs do not include exhaust air interception and the necessary construction costs.

The operating costs are largely made up of the energy costs for running ventilators and humidifier pumps. There are also costs associated with the water required for humidification, the maintenance of the biofilter and the replacement of filter material at the end of its service life. The energy costs amount to EUR 0.15 – 0.225/1000 m³ of exhaust air, calculating electricity costs at EUR 0.15/kWh. Including the above listed additional costs, the price for the treatment of 1000 m³/h exhaust air then amounts to EUR 0.225 – 0.30.

Soil beds have a potentially high odour removal efficiency at a relatively low cost when compared with alternative treatment techniques.

Driving force for implementation

To avoid complaints about odours and to meet legal requirements.

Example plants

Widely used in the FDM sector (an example from the coffee sector is shown in Section 4.7.8.3).

Reference literature

[65, Germany, 2002]

4.4.3.10.2 Bioscrubber

Description

Bioscrubbers are absorbers in which an intensive exchange of substances takes place between the polluted gas and the absorbent. The micro-organisms are either finely divided in the collecting liquid or applied as a layer to the absorber structures or trickling filter. The absorber is followed by a mist collector to separate the gaseous and liquid phases. In the subsequent absorbent regeneration step, the waste gas constituents absorbed in the liquid phase are removed from the absorbent. For waste gases with high particulate levels, the gas needs to be passed through a dust remover before the bioscrubber.

The technique essentially comprises a packed bed absorber containing a bacterial population within the packing and the sump. The contaminated gas is passed up the tower against a flow of water containing a population of bacteria. The bacteria attaches itself to the packing in a similar manner to a trickling filter used for waste water treatment (see Section 4.5.3.1.5). Nutrients, required for bacterial growth and synthesis, are added to the absorber sump on a periodic basis. A typical layout of a bioscrubber installation is shown in Figure 4.33.

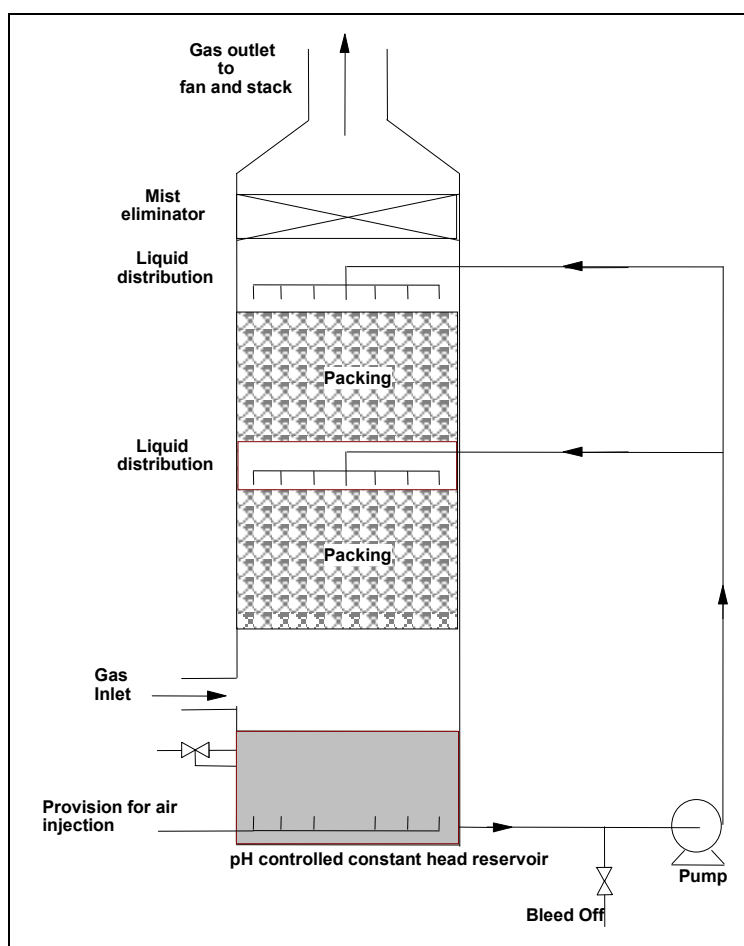

Figure 4.33: Bioscrubber layout

Achieved environmental benefits

Reduced air emissions, e.g. odour/VOCs.

Cross-media effects

The bioscrubber is more energy intensive than the biofilter as water is being recirculated in addition to the air movement. Disposal of the filter material.

Operational data

The size of a bioscrubber is not restricted by the airflow to be treated, although the resultant size of a single packed tower may necessitate two parallel systems. A limit to the maximum concentration of contaminants in the inlet airstream is generally documented as less than 5000 mg/Nm^3 , although a concentration limit of 1000 mg/Nm^3 may be used as a guideline when assessing the suitability of bioscrubbing.

The speed of biodegradation is relatively slow, thus operating conditions may have a crucial role. A bioscrubber operates at a typical residence time of 5 – 15 seconds, depending on the airstream to be treated. Bioscrubbers require a much smaller land area than biofilters.

Applicability

Used to eliminate biodegradable gaseous air pollutants, especially organic pollutants and odours. In theory, a bioscrubber can be used wherever bio-oxidation is an appropriate solution to an emission problem and its applications are, therefore, similar to that for biofilters, however, biofilters are more widely applied. This technique is not applicable for airborne temperatures in excess of 40°C .

Economics

A relatively high odour removal efficiency at relatively low cost when compared with alternative treatment techniques.

Reference literature

[34, Willey A R and Williams D A, 2001, 65, Germany, 2002]

4.4.3.11 Thermal treatment of waste gases

Certain gaseous pollutants and odour can be oxidised at high temperatures. The speed of the reaction increases exponentially with temperature.

Oxidisable pollutants include all organic compounds, as well as inorganic substances such as carbon monoxide and ammonia. Given complete combustion, carbon and hydrogen react with oxygen to form CO₂ and water. Incomplete combustion can result in new pollutants such as carbon monoxide and in totally or partially unoxidised organic compounds. If the waste gas contains elements such as sulphur, nitrogen, halogens and phosphorus, combustion gives rise to inorganic pollutants such as oxides of sulphur, oxides of nitrogen and hydrogen halides, which subsequently have to be removed by means of other waste gas purification processes if the concentrations are too high. This restricts the field of applications for the combustion of pollutants.

There are a number of safety requirements, in particular:

- the need for protection against flame flashback between the thermal oxidiser and the gas stream to be treated. This can generally be achieved via a flame arrestor or water seal
- on start-up, before the burner is ignited, the thermal oxidiser needs to be purged with air by a volume equivalent to five times the plant volume. Any re-ignition of burners during the operation is preceded by a burner purge period
- when the air is rich in solvents, a risk assessment is required.

4.4.3.11.1 Thermal oxidation of waste gases

Description

For complete oxidation of the compounds to be degraded in the airstream, it is necessary for them to be in contact with sufficient oxygen for a long enough time and at a high enough temperature. Rapid oxidation of organic compounds will occur if the gas temperature in the thermal oxidiser can be maintained at 200 – 400 °C higher than the auto-ignition temperature of the chemical species present. In thermal oxidation, the pollutant conversion takes place at high temperatures, e.g. >600 °C.

In addition to considering the applicability of thermal oxidation to the components to be destroyed, it is important to consider the recovery of heat from the thermal oxidation process to reduce fuel costs. As FDM air emissions seldom have organic concentrations in the region of the lower explosive levels, the conventional type of thermal oxidisers, which have direct flame contact with the airstream to be treated, are mostly used. In cases where there is a high concentration of organics above the relevant explosive limits, then a flameless type of system may be required. These systems use a heating medium to heat the airstream and, thus, avoid direct contact of the airstream with the flame.

Direct flame thermal oxidisers usually operate at temperatures of between 700 and 900 °C. The reaction temperature depends on the nature of the pollutant; it may be lower, but for less readily oxidisable substances such as organohalogen compounds it may be in excess of 1000 °C. For malodorous compounds, a temperature of 750 – 800 °C is generally adopted. The conditions of the equipment stages of a thermal oxidiser are illustrated in Table 4.39. A typical layout of a thermal oxidiser is shown in Figure 4.34.

Equipment stages	Conditions
Burning	The fuel is burned with clean air or with a proportion of the contaminated air to produce a flame at a temperature of typically 1350 – 1500 °C
Mixing	To ensure adequate turbulence and hence mixing of the process gas to bring it to uniform temperature
Combustion	The gases are held at the combustion temperature until oxidation has been completed, typically 0.5 to 1.0 seconds
Heat recovery	Reduces operating costs and fuel consumption

Table 4.39: Conditions at different stages of thermal oxidation

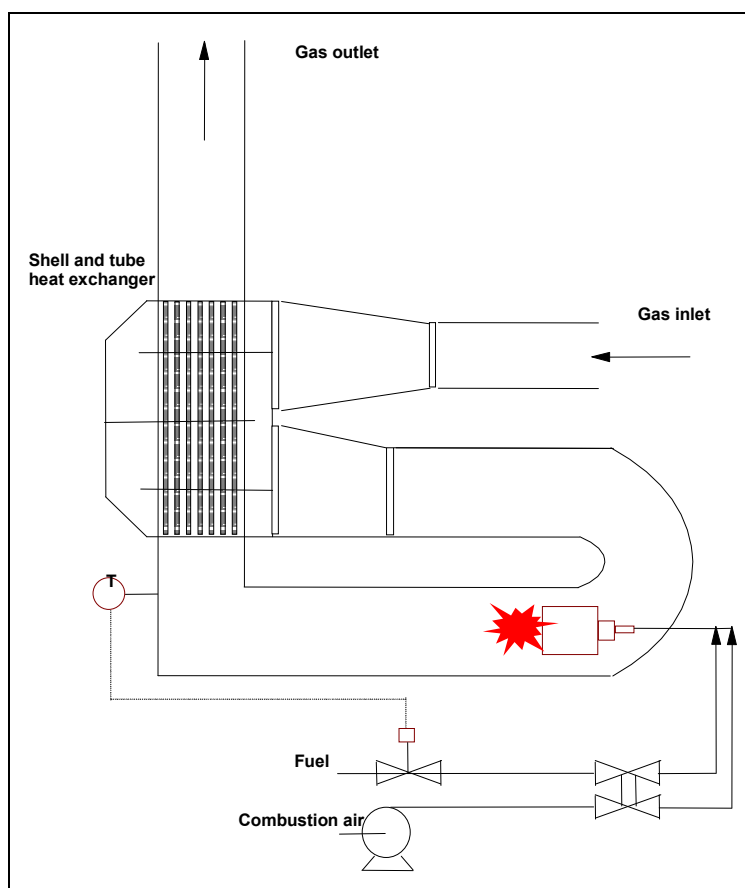

Figure 4.34: Thermal oxidiser layout

Burners can be divided into those with a single flame and those in which the fuel is distributed between a large number of jets. With regard to the shape, laminar-flow, nozzle and vortex burners are possible. In special cases, the burner may be replaced by an electric heating system. The oxygen required for combustion can be taken from the air, the airstream to be treated, or alternatively from a proportion of each. Possible supplementary fuels include light heating oil, natural gas or LPG. Care needs to be taken and due vigilance paid to the potential for any water vapour present in the airstream to quench the flame, thereby resulting in poor combustion.

The burner also may be of the pre-mix type where the fuel is mixed with the combustion air prior to passing through the nozzles, or a diffusion type where the fuel is mixed with the combustion air downstream of the nozzles. Most burners are of the diffusion type.

The **mixing** of the gas stream may be achieved in a variety of ways; by natural diffusion, impingement mechanisms, or by the inclusion of baffles to induce flow changes. Suppliers offering low NO_x systems often incorporate various backmixing sections, with the intention of reducing temperature increases significantly above the mixed temperature.

The **combustion** chamber in which the oxidation reaction takes place must be designed for high thermal stresses. Some combustion chambers are made of heat resistant metal and chambers with a metal jacket and refractory lining. The dimensions of the combustion chamber are sufficient to achieve the desired residence time and to accommodate the physical length of the flame without quenching.

Some form of **heat recovery** is nearly always warranted to reduce operating costs and fuel consumption. Heat recovery is conventionally conducted in a shell and tube heat-exchanger, which allows heat to be continuously transferred to preheat the incoming gas stream. This type of system is termed a recuperative system, with 70 – 80 % heat recovery being a typical design level.

Heat recovery can also be achieved in a regenerative system, which uses two sets of ceramic bed heat-exchangers. There, one bed is heated by direct contact with the exhaust gas while the other is used to preheat the incoming gases. The system is operated so that the beds alternate between heating and cooling. The heat recovery potential of this system is higher than the recuperative system, with 80 – 90 % heat recovery being a typical design basis. The use of thermal fluids is an alternative to this type of system.

Heat can also be recovered using a waste heat boiler where the treated exhaust gases are used to produce steam for use in other parts of the installation or site. The operation of the thermal oxidiser may not always coincide with the demand for steam, so integration may be complex.

There is also a potential for secondary heat recovery, using the treated exhaust from the first stage heat recovery to heat water or for space heating.

It is reported that the heat from the combustion can be recovered in a cross heat-exchanger and used for the cooking process instead of steam. It is reported that combustion of smoke gases from cooking/smoking kilns will eliminate all odour problems in the close environment.

Further information about this technique, its actual performance and how this compares with other air abatement techniques is given in the “Waste water and waste gas treatment BREF” [217, EC, 2003]

Achieved environmental benefits

Reduced gas and odour emissions.

Cross-media effects

There is a potential of the oxidation process to generate unwanted by-products of combustion, e.g. high levels of NO_x and CO₂. Essentially, the higher the reaction temperature then the greater the potential for the generation of increased levels of NO_x. It is usually beneficial to opt for a low NO_x burner.

Any compounds containing sulphur present in the malodorous gas stream will generate SO₂ emissions and the potential for minimising this should be considered. The presence of chlorides in the malodorous airstream may need to be reviewed due to the potential formation of acidic gases such as HCl. As well as leading to emissions, there could be potential corrosion problems within the equipment. When halogenated VOCs are present, special conditions to suppress the formation of dioxins may be required, though normally there is negligible dioxin formation during the combustion of waste gas streams [217, EC, 2003].

Energy consumption, e.g. consumption of fuel for operating the oxidiser.

Operational data

Thermal oxidisers do not operate effectively until they reach the combustion temperatures of the pollutants they are used to destroy, so they need to be started up before they are actually required.

A properly designed and operated thermal oxidiser can achieve odour removal efficiencies approaching 100 %. The performance of this technique is independent of the intensity of the odour emissions.

Malodorous airstreams containing significant quantities of particulate material generally require pretreatment prior to the thermal oxidation process. This is particularly relevant if a heat recovery system is installed, due to a potential fouling of the heat-exchanger.

Whilst the presence of high levels of water vapour in an airstream is not considered a process problem, the fuel requirements are greater than for heating dry air. In practice, the removal of water vapour from an airstream is usually not undertaken and additional fuel requirements are usually included in the overall economic consideration of thermal oxidation as a technique.

Thermal oxidation of waste gases can achieve VOC levels of $<1 - 20 \text{ mg/m}^3$ [217, EC, 2003].

In a Norwegian investigation of smoking sausages, when examining a cooking/smoking cabinet, the following emissions were found after the thermal oxidation of the smoke gases: 7 mg TOC/m^3 or 0.2 mg TOC/t sausages. The gas did not contain CO.

At an example smokehouse with an annual production of around 3000 tonnes of smoked products, waste gases from smoking are burned using a direct flame thermal oxidiser. The waste gas from the “smokeless” process phases, which do not require emission abatement, are not treated. The system is regarded as a robust waste gas treatment requiring little maintenance.

The thermal oxidiser is heated to its operating temperature before the smoke generators are operated. During smoking, the exhaust gas fan force-feeds the smoke-laden waste gas through a waste gas bypass flap to a preheater. Here, the dirty gas is heated to $300 - 350 \text{ }^\circ\text{C}$ before it enters the combustion chamber, where it is mixed with the hot gases from the gas burner. After treatment, the clean gas is used to preheat the dirty gas by using an integrated heat-exchanger and it is cooled to $400 - 450 \text{ }^\circ\text{C}$ before it is discharged to air via a flue stack.

Table 4.40 shows technical data for direct flame thermal oxidation in the example smokehouse. A flow diagram of the origin and process management of flue-gas from this smokehouse is illustrated in Figure 4.35.

Dimensions	
Total length including burner	4250 mm
Total length excluding burner	3750 mm
Diameter	1150 mm
Dirty gas connection	200 x 200 mm or 200 mm diameter
Clean gas connection	300 mm
Weight	approximately 1250 kg
Rated connections	
Fuel	Oil
Electrical connection	220 V/50 Hz (approximately 1 kW)
Exhaust gas fan	380 V/50 Hz (approximately 4 kW)

Table 4.40: Technical data of a direct flame thermal oxidiser applied in a smokehouse

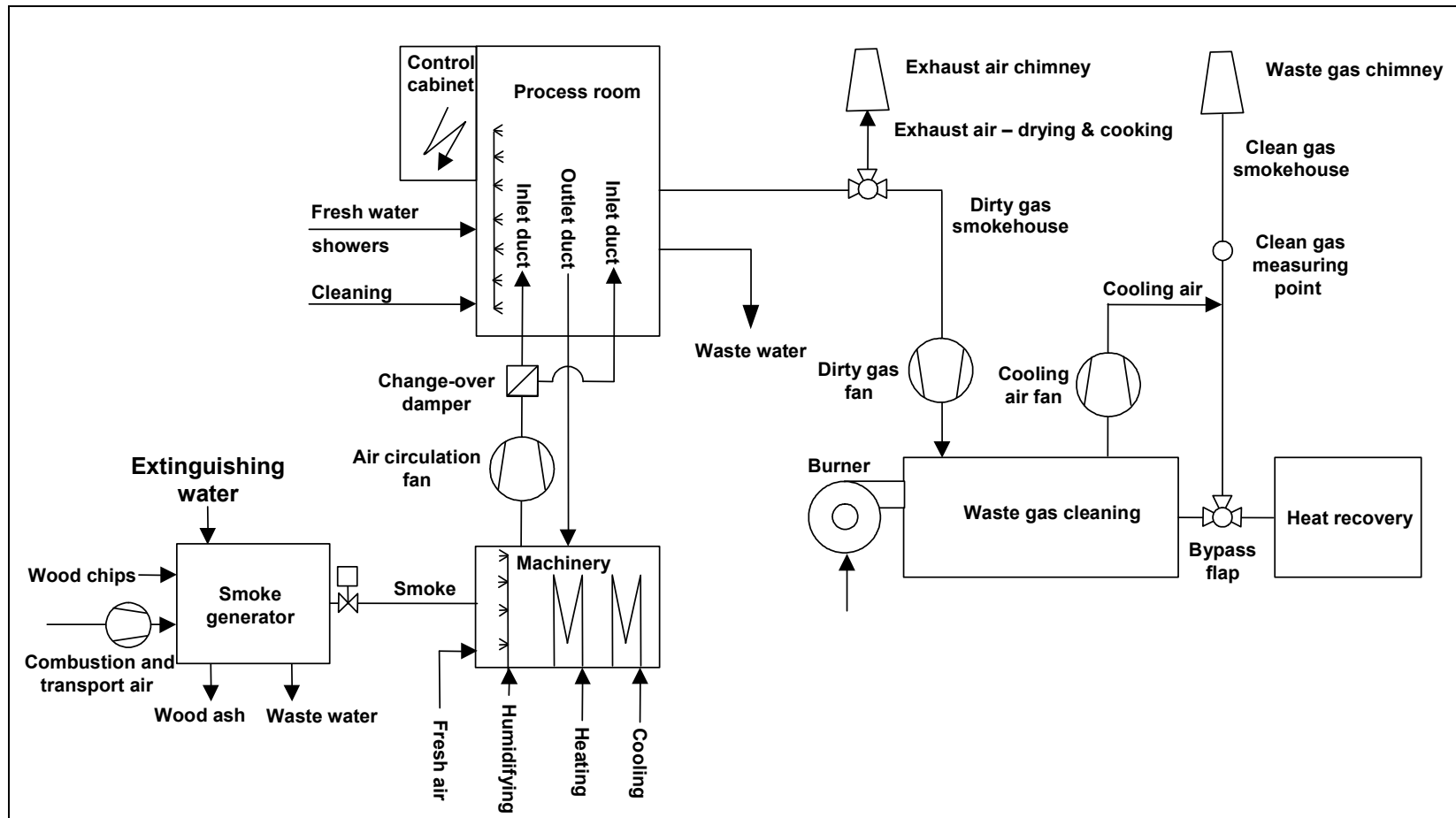

Figure 4.35: Flow diagram showing the origin and process management of the flue-gas from the waste gas cleaning system of a smokehouse

In the example smokehouse, all smoke units, regardless of their size, are equipped with a smoke generator. The smoking intensity is determined by the smoking time which is approximately 60 – 120 minutes/batch. The flowrate for one smoke generator is 200 Nm³/h, resulting in a total flowrate for 11 smoke chambers of approximately 2300 Nm³/h. Applying a realistic parallel operating factor of 75 %, the actual flowrate is 1650 Nm³/h. Table 4.41 shows technical data for the direct flame thermal oxidiser used.

Parameter	Value	Comments
Waste gas flowrate	2300 m ³ /h	Normal state (i.e. 0 °C, and 1013 mbar, dry)
Burner capacity	600 kW	The capacity is continuously modulated
Substance concentration in waste gas	Achieved level not reported (<50 mg/Nm ³ TOC ≤0.115 kg/h)	2300 Nm ³ /h x 50 mg/Nm ³ = 0.115 kg/h

Table 4.41: Technical data for a direct flame thermal oxidiser applied in a smokehouse

It is reported that at 620 to 660 °C, complete removal of odour emissions is achieved and as a general rule, TOC is emitted at an unspecified level below 50 mg/Nm³. Direct flame thermal oxidation can be run at temperatures of up to 1000 °C. The effectiveness of the technique depends on several parameters such as operating temperature, residence time and mixing conditions in the combustion chamber. TOC levels of less than 10 mg/Nm³ are readily achieved.

Figure 4.36 shows the balance of substances as an input/output diagram for the waste gas treatment system.

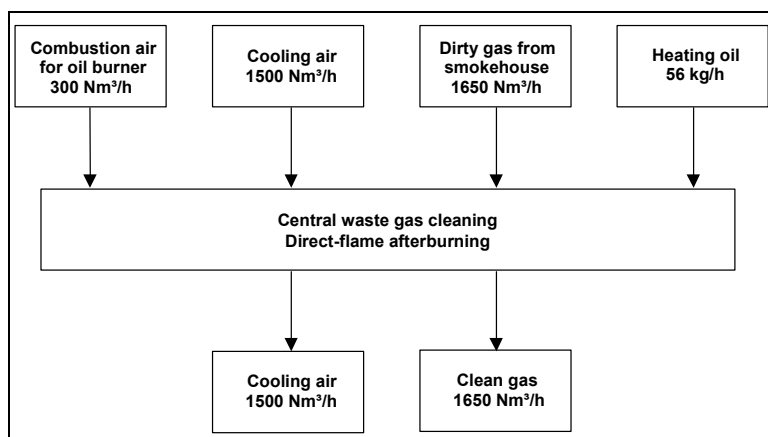

Figure 4.36: Mass balance of a waste gas treatment system with direct flame thermal oxidation

Applicability

Used for the removal of VOCs/odour. Thermal oxidation has the advantage of being almost universally applicable as a method of odour control because most malodorous components can be oxidised to non-malodorous products at a high temperature, whereas the application of other methods are more restrictive.

Thermal oxidation is generally used for the treatment of low volumes of less than 10000 Nm³/h, the driving factor being the increased costs for heating greater volumetric airflows. It is suitable for malodorous streams with variable contaminant concentrations and is capable of treating a variable volumetric throughput.

If alkali metals are present from the soil in vegetable drying plants, they may cause premature degradation of the ceramic media used for regenerative heat recovery.

Economics

This technique requires high capital investment, but the major consideration when assessing the suitability of thermal oxidation is the operating cost in terms of the fuel requirements. The use of recuperative or regenerative heat recovery systems can improve the efficiency of the technique and reduce the running costs. Retrofitting is possible for all types of smoking kilns, at varying cost. Smoking kilns are available with integrated thermal oxidation equipment.

Example plants

Used in at least one smokehouse in Germany and in smokehouses in the Nordic countries.

Reference literature

[34, Willey A R and Williams D A, 2001, 41, Nordic Council of Ministers, 2001, 65, Germany, 2002]

4.4.3.11.2 Oxidation of waste gases in an existing boiler

Description

It may be possible to direct the malodorous gases to an existing on-site boiler. This has the advantage of using existing equipment and avoiding the expense of investing in an additional treatment option. The principle of operation is essentially the same as for thermal oxidation in a purpose built plant.

The malodorous exhaust stream is ducted to the combustion airflow fan of the boiler or boilerhouse, then to the boiler. It provides oxygen to the combustion process and the malodorous components are destroyed.

The overall feasibility of using an existing boiler largely depends upon the volume of malodorous air to be treated in relation to the boiler combustion air requirements under the extremes of load. If the volume of malodorous air is significantly less than the combustion air requirements then it is unlikely to present a problem. The total volume of malodorous air could simply be ducted through the combustion fan. However, the vast majority of operating conditions result in the boiler operating in a cyclic mode in response to a steam pressure signal.

Potential implications to the boiler operation need to be fully ascertained. The safety features associated with routing a malodorous discharge to a boiler are essentially included in the existing boiler operation. Flame arrestors or water seals may need to be added to prevent flame flashback between the boiler and the gas stream to be treated.

Achieved environmental benefits

Reportedly highly efficient and, if correctly operated, as efficient at eliminating odours, including intense odours as other burning methods.

Cross-media effects

Energy consumption. Fuel consumption may be raised as it may be necessary to keep the boiler running, when it would otherwise not have been required.

Operational data

The normal operation of a boiler is to generate steam in line with the demand from the installation as judged continuously from the steam pressure signal at the boiler outlet. As the steam pressure increases to its set point, the boiler will respond by reducing the fuel flowrate to the burner. The combustion airflow, being electrically or mechanically linked to the fuel feed rate, will also reduce to maintain optimum combustion conditions. If the combustion airflow rate at this low firing condition is lower than the volume of malodorous air to be treated, then the control strategy of the boiler would need to be changed. Also, a knowledge of the oxygen content of the malodorous air, if it is suspected to be less than 21 %, will further help with the initial feasibility exercise.

The control strategy could change from being dependent upon the steam pressure to being dependent upon the combustion airflow rate. The combustion airflow rate would then be set to a minimum, i.e. equivalent to the volume of malodorous air to be treated, which in turn would set a minimum fuel flowrate and firing rate. When the steam set point pressure is achieved, the boiler reverts to operation at the minimum combustion airflow rate and the unwanted heat is discharged through the boiler stack. A key part of the evaluation is to ascertain the percentage of time that the boiler operates with a combustion airflow rate lower than the malodorous flowrate, to calculate additional fuel costs.

An important initial consideration is to check whether the boiler would be operating when malodorous gases are produced. This, for most operations, is likely to be the case.

Applicability

Used for the removal of gaseous pollutants and odour. Suitable for low volume, high concentration odours.

Economics

The potential to use an existing boilerhouse has economic benefits, both in terms of capital costs and operating costs.

Driving force for implementation

Compliance with legal requirements.

Reference literature

[34, Willey A R and Williams D A, 2001]

4.4.3.11.3 Catalytic oxidation of waste gases

Description

Catalytic oxidation is a process similar to thermal oxidation with the fundamental difference being that the oxidation reaction takes place in the presence of a catalyst rather than in free air. The main advantage of catalytic oxidation is that significantly lower operating temperatures are required, e.g. 250 to 500 °C.

As with adsorption, the reactants for the heterogeneous gas reaction must first be transported to the inner surfaces of the generally porous catalysts. As there is a general lack of adequate substance data, such as the reaction speed constant and the diffusion coefficient, reactors are usually designed on the basis of empirical data.

The main components of a catalytic combustion system are auxiliary firing equipment, a heat-exchanger and a reactor with a catalyst. A typical layout of a catalytic incinerator is shown in Figure 4.37.

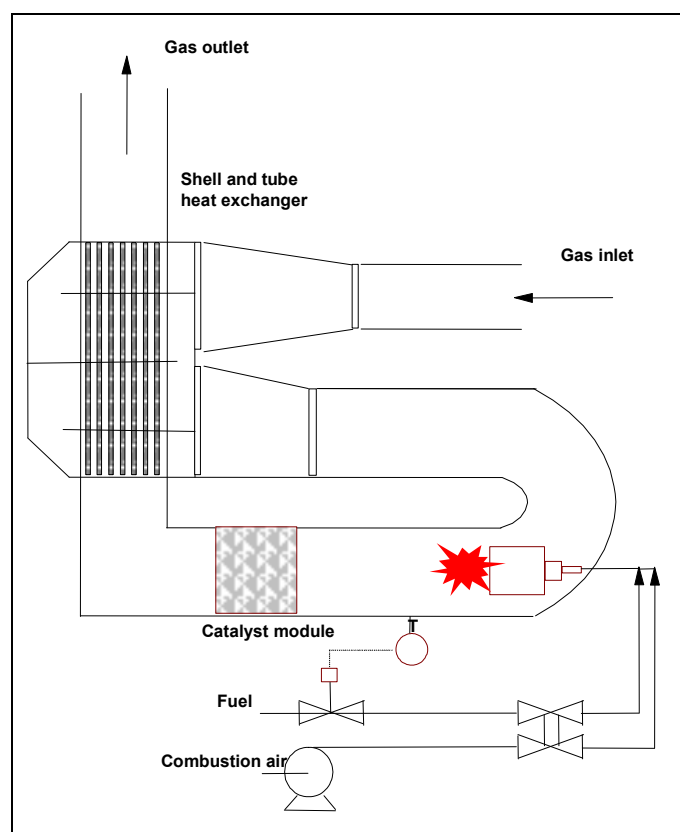

Figure 4.37: Catalytic incineration layout

The airstream enters the unit and is preheated in a conventional shell and tube heat-exchanger. The preheated inlet stream is then further heated via a burner to the desired oxidation temperature, before passing onto the catalyst. The contaminants present in the malodorous airstream, together with oxygen, diffuse onto the surface of the catalyst. Oxidation takes place and the products of oxidation are desorbed back into the gas stream. These transfer processes require a finite time within the catalyst, with the rate of reaction being strongly influenced by the operating temperature. The treated gas stream then passes through the heat-exchanger, warming the incoming malodorous airstream.

The most important aspect of a catalyst bed is the ratio of surface area to volume and hence the available area for the reaction.

Active components commonly used include metals of the platinum group and oxides of the metals Co, Cr, Cu, Fe, Mo, Ni, Ti, V, and W. The support materials are usually metals, in the form of plates, woven fabrics or nets, metal oxides, e.g. Al_2O_3 , SiO_2 and MgO , and minerals, e.g. pumice and zeolite, in moulded shapes.

The following design pointers are considered when evaluating the potential of catalytic incineration as a possible abatement solution: space velocity, pressure drop and temperature.

The **space velocity** is defined as the reciprocal of the residence time of the gas within the catalyst block, with the volumetric airflow expressed at 0 °C. A typical range of space velocities used in industrial applications is between 20000 and 45000 m/h. This corresponds to a residence time range of 0.03 to 0.1 seconds at typical operating temperatures. Essentially, there is a trade-off between the amount of catalyst incorporated into the design and the operational temperature. The more catalyst and, hence, operation towards a space velocity of 20000 m/h, then the lower the operational temperature required to achieve a given performance. If the airflow to be treated is large, then there is scope to incorporate an additional catalyst to reduce fuel costs by heating to a lower operational temperature. However, an increased catalyst charge will create an increased pressure drop, thereby requiring additional extraction fan power.

The catalyst exhibits a linear relationship between flowrate and **pressure drop** due to the laminar flow within the catalyst. A typical design would allow for a total system pressure drop of approximately 500 mm. The configuration of the catalyst block plays an important role in minimising the pressure drop and hence the operating costs.

Catalytic oxidation is an exothermic reaction. There are installations where the temperature increases to a sufficient magnitude to enable the catalytic oxidiser to operate in a self sustaining mode without the addition of fuel after the operating conditions are reached.

Heat recovery is an essential part of the process and is usually integrated within the design, by using the treated gases to preheat the incoming gases. Heat-exchangers are typically designed with an 80 °C heat recovery, which effectively results in a final discharge temperature of between 150 and 200 °C for typical oxidation temperatures.

Catalytic incinerators occupy less space than waste gas incinerators.

Achieved environmental benefits

Reduced gas and odour emissions.

Cross-media effects

There is a potential of the incineration process to generate unwanted by-products of combustion, e.g. high levels of NO_x and CO₂. Essentially, the higher the reaction temperature then the greater the potential for the generation of increased levels of NO_x. It is usually beneficial to opt for a low NO_x burner. There is a relatively low formation of NO_x at operating temperatures and levels of 15 mg/Nm³ can be achieved.

Any compounds containing sulphur present in the malodorous gas stream will generate SO₂ emissions and the potential for minimising this should be considered. The presence of chlorides in the malodorous airstream may need to be reviewed due to the potential formation of acidic gases such as HCl. As well as leading to potential emissions, there could be potential corrosion problems within the incinerator. When halogenated VOCs are present, special conditions to suppress the formation of dioxins may be required, though normally there is negligible dioxin formation during the combustion of waste gas streams [217, EC, 2003].

Energy consumption, e.g. consumption of fuel for operating the incinerator.

Operational data

Catalytic oxidisers do not operate effectively until they reach the combustion temperatures of the pollutants they are used to destroy, so they need to be started up before they are actually required.

Catalytic incineration of waste gases can achieve VOC levels of <1 – 20 mg/Nm³ [217, EC, 2003]. Carbon monoxide levels of <100 mg/Nm³ have been reported. In contrast, the NO_x levels can reach extremely high values, e.g. levels of around 1000 mg/Nm³ have been reported during catalytic incineration.

Legal requirements in Germany are largely met by using catalytic incineration, but are completely met by using incineration.

Compared to incineration, catalytic incineration requires a lower operating temperature and has no need for special construction materials. The likely odour removal performance of a catalytic incinerator is in the region of greater than 95 %, which is less than the approaching 100 % reported for incineration.

Compounds such as sulphur, halogens, zinc and organic solids tend to coat the catalyst surface. Fortunately, this process is reversible with the catalyst activity re-achievable by the application of a high temperature. Inert particulate material will also result in a gradual decrease in catalyst activity, although the application of a high temperature, approximately 500 °C, will return the catalyst activity.

The presence of dust in the gas stream tends to accumulate at the front edge of the catalyst, resulting in a gradual increase in the catalyst pressure drop. Whilst the literature would suggest that dust concentrations of up to 115 mg/Nm³ are possible, in practice a maximum concentration of 50 mg/Nm³ is mentioned as a guideline.

The honeycomb structure is more effective than other structures in minimising problems of attrition, mechanical stability, excessive pressure drop and chemical stability in oxidising atmospheres.

The effective lifetime of the catalyst is largely dependent upon the nature of the airstream being treated. Lifetimes reported vary considerably over a range of two to ten years, although they are more typically between three and five years.

Smokehouse waste gases are often treated using catalytic oxidation, at temperatures of between 350 – 450 °C. Precious metals (platinum, palladium) or certain metal oxides (copper, chromium) deposited on ceramic surfaces are used as catalysts. They are sensitive to dust, fat aerosols and catalyst poisons such as lead and other metals. The efficiency is reported to be high and heat can be recuperated.

Applicability

Used to reduce emissions of gaseous pollutants and odour at low dust concentrations. They can operate with airstreams of variable temperature and odour load.

Economics

Lower fuel costs compared to incineration. The catalyst replacement cost, at approximately GBP 50000/m³ (2001), is an important parameter in the calculation of operating costs.

Driving force for implementation

Compliance with legislation on odour control.

Example plants

Used in the coffee sector in Germany (see Section 4.7.8.4.3) and to treat smokehouse waste gases in the Nordic countries.

Reference literature

[34, Willey A R and Williams D A, 2001, 41, Nordic Council of Ministers, 2001, 65, Germany, 2002]

4.4.3.12 Non-thermal plasma treatment

Description

Non-thermal plasma treatment is an odour abatement technique based on creating a highly reactive treatment zone in the waste gases in which the malodorous molecules are broken down. The way in which this reactive zone is created may vary.

Plasma is a gas state in which the gas component molecules are separated into a collection of ions, electrons, charge-neutral gas molecules and other species in varying degrees of excitation. Depending on the amount of energy added, the resulting plasma could be characterised as thermal or non-thermal.

In thermal plasma, the plasma constituents are in a thermal equilibrium. The ions and electrons are, on average, at the same temperature corresponding to approximately 1 – 2 eV (where 1 eV corresponds to a temperature of 11327 °C). The electric arc in an electric arc furnace is an example of thermal plasma.

In non-thermal plasma, the electron energy levels, or speeds, are considerably higher than those of the bulk gas molecules. Because energy is added to the electrons only, these can attain energies from 1 – 10 eV, while the background gas remains at the equivalent of ambient temperature. The high electron energies generate plasma in which free electrons, ions and radicals coexist.

Non-thermal plasma can be used to treat malodorous waste gases at ambient pressure and temperature. The radicals in the plasma react with the pollutants, which are broken down and oxidised to produce less malodorous components. The most active radicals in this process are nitrogen-, oxygen-, and hydroxyl-based. These species originate from nitrogen, oxygen and water in the waste gas.

Industrial treatment systems are based on electrical discharge, where high voltages (up to 40 kV) are used to create plasma within the waste gases.

Figure 4.38 shows a proprietary design of an industrial non-thermal plasma treatment system.

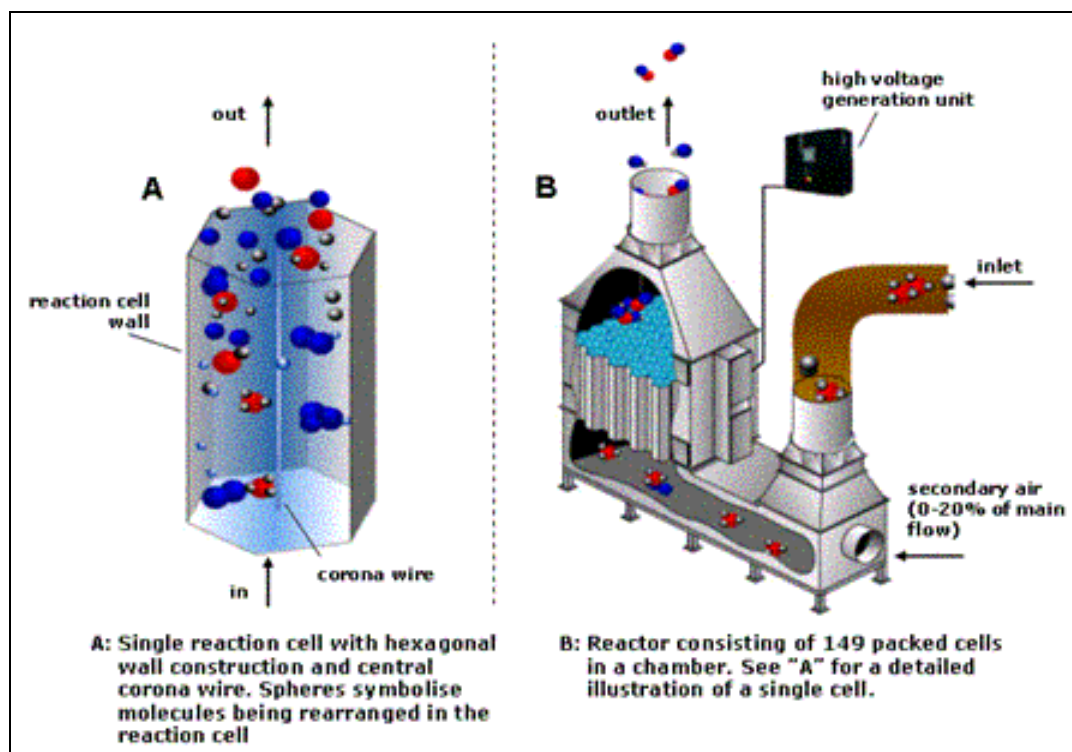

Figure 4.38: Industrial non-thermal plasma treatment equipment

Equipment for the non-thermal plasma treatment of odours is of modular design with a light and compact construction. One module treats air volumes of 20000 – 25000 Nm³/h. When larger treatment capacities are required, multiple modules can be installed in parallel. The technique requires no process additives and no consumables for the operation, apart from power. It has a low pressure drop, in the range 30 – 180 Pa. It can be installed both on the suction side and the pressure side of the main air extraction fan.

Achieved environmental benefits

Reduced odour emissions.

Cross-media effects

Energy is required to create the plasma and to transfer air to the gas mixture for the process and for cooling and water condensation. Ozone is generated. Waste water, contaminated with, e.g dust is produced.

Operational data

The technique has been proven to reduce the odour emissions by 75 – 96 %, depending on the design, process conditions and odour characteristics. Table 4.42 shows data for some fish-meal example installations.

Industry	No. of samples	Odour in (average) (OU/m ³)	Odour out (average) (OU/m ³)	Average (range) reduction efficiency (%)
Fish-meal	3	15833	3233	80 (± 4)
Fish-meal	3	16350	1600	90 (± 1)

Table 4.42: Odour reduction using non-thermal plasma treatment

The power consumption is reported to be 6 – 12 kW (1.67 – 3.33 J/h) for a treated volume of 20000 – 25000 Nm³/h (one module). This includes the energy used by the high voltage generation unit, but excludes increased energy consumption in the main exhaust fan to overcome the pressure drop (30 – 180 Pa) of the unit and the energy required for any extra air. Extra air may be needed to maintain a sufficient level of radicals in the gas mixture and possibly for cooling the gases to the temperature where the technique is most efficient, i.e. between 15 and 80 °C, or to condense water upstream of the treatment unit. The need for additional air can be up to 20 % of the treated volume and is normally supplied by a dedicated fan.

Ozone is generated in the plasma reactor and emitted to the air. In industrial applications, ozone levels are kept well below 1 ppm by volume, although this is generally not monitored after commissioning. NO_x and SO_x are not generated in detectable quantities, due to inorganic compounds like NH₃ and H₂S, not being effectively destroyed.

Table 4.43 shows some data reported from various industries in the FDM sector.

Country applied	Industry	Treated source	Treated volume (Nm ³ /h)	Installed (year)
Denmark	Fish-meal	Extruders, driers, coolers	22000	2000
Denmark	Dry peas and pea products	Extruders, driers, coolers, hammer mills	25000	2001
Denmark	Proteins	Driers	25000	2002
Denmark	Oil extraction	Driers	25000	2002
Denmark	Animal feed	Driers, coolers	50000	2002
Germany	Fish-feed sterilisation		6000	2003
Greece	Fish-meal	Extruders, driers, coolers	44000	2000
Greece	Fish-feed	Driers and coolers	22000	2004
Norway	Fish-meal	Extruders, driers, coolers	1750000	1998
Norway	Fish-meal	Extruders, driers, coolers	115000	1998
Norway	Fish-meal	Extruders, driers, coolers, hammer mills	40000	2000
Japan	Fish-feed	Driers and coolers	20000	2004
United States	Fish-meal and petfood	Extruders, driers, coolers	25000	2002

Table 4.43: Volumes treated at some installations that apply non-thermal plasma to reduce odour emissions

Like many end-of-pipe techniques, the technique performs better when treating a highly concentrated flow than a flow with a low concentration of pollutants.

Field tests on specific odour compositions determine the design of the installation and the guarantees that are given. If the full-scale installation has to treat significantly different odour molecules, e.g. due to changes in raw materials or concentrations, this may influence the performance. This is normally solved by introducing different system settings for different products/recipes, controlled automatically from the plant's central control system.

The technique is reported to operate well with up to 100 % humidity. One installation reports that when the waste gas was oversaturated with water (>100 % humidity) this caused “raining” inside the reactor. The water droplets in the reaction chamber led to frequent spark-over in the reaction zone, resulting in a reduced power input to the airstream and consequently a reduced cleaning efficiency. In situations like this, the power setting of the system can be reduced to limit the amount of spark-over to an acceptable level, i.e. ≤ 20 sparks/min. In the reported case, the achieved cleaning efficiency was still high enough to meet the authority requirements for total allowed odour emission, so the customer accepted the system performance without modification. This type of problem is normally solved by admixing up to 20 % cold air, to stimulate condensation and installing a mist filter prior to the plasma treatment unit. This has been carried out in several plants.

Above 80 °C, the performance of the technique drops significantly, due to the electrochemical characteristics of the waste gas, so a maximum input temperature of 70 °C is specified. Airstreams at higher temperatures can be cooled by adding air at ambient temperatures.

The equipment is engineered to treat a specified volume of air and built as modular units, normally to handle 20000 m³/h/module. For higher volumes, several modules can be installed in parallel. However, if the actual flow is significantly different from the design parameters, there might be an effect on the performance.

In addition to odour destruction, the plasma reactor also acts like an electrostatic precipitator. For a dust-laden airstream, there will, therefore, be a build-up of dust over time in the reaction chamber and on the corona wire. The speed of this build-up will depend on the dust load and the dust characteristics. Experience has shown that the plasma technique works well with dust loads of < 25 mg/Nm³. In such circumstances, the reactor can be in continuous operation for up to several months, after which cleaning is normally required. For this reason, many of the industrial applications are equipped with a wet cleaning system that operates (semi)automatically during production stops and flushes the collected dust to a WWTP. At very high dust loads, there is a risk of clogging the equipment and frequent cleaning is required. In addition, high dust concentrations in the waste gas will increase the frequency of spark-over and may reduce the odour cleaning efficiency. Normally such high concentrations will only occur during failure of upstream dust abatement equipment.

Applicability

Non-thermal plasma treatment can be installed as an end-of-pipe solution to malodorous waste gases in the FDM industry. This includes, e.g. the emissions from extruders, driers, coolers and hammer mills. The technique is applied to various types of waste gas, including those containing dust, although upstream dust abatement may be required. The most odorous waste gases contain a mixture of organic and inorganic components. The plasma process has a high performance for organic components, but is less efficient at removing some inorganic components, e.g. NH₃ and H₂S. This is due to the fact that the energy densities currently achievable have insufficient power to break down these compounds. The technique has to be protected from significant amounts of water condensing on the equipment.

Due to changes in waste gas conductivity, non-thermal plasma technology is less effective at waste gas temperatures exceeding 80 °C.

There are some outstanding concerns about the reliability and performance of this technique and possible safety concerns when the technique is used to treat airstreams which may cause a fire and explosion hazard. At the time of writing, its application and performance in the FDM sector is still being evaluated.

Economics

According to the technology supplier, one module (treating between 20000 and 25000 Nm³/h) will cost around NOK 1 million, which corresponds to around EUR 117000 (March 2004). This includes the necessary equipment, electromechanical service and commissioning from the supplier, but excludes mechanical installation. Annual maintenance costs are approximately 3 to 5 % of the investment costs. Consumables include power and minor quantities of rinsing water.

Example plants

In the FDM industry, the technique has reportedly been applied on an industrial scale in several fish-meal factories and in the production of pea products, petfood, proteins, oil extraction and animal feed. It has also been applied in at least one waste sorting plant in Denmark, a manure processing plant in Norway and a pharmaceuticals plant in Norway. It has been applied for its electrostatic cleaning effect in at least one silicon carbide installation in Norway.

Referencer literature

[146, Leendertse. A., 2003, 193, Leendertse A. and Haaland A.T, 2003]

4.4.3.13 Physical dispersion of odour/VOC emissions

Dispersion is sometimes used via existing installations on the site, e.g. using a high discharge boiler stack. The legislation governing malodorous emissions, if they are not also considered to be harmful, is impact related and not source controlled. This means that, the need to treat a malodorous emission is governed by the impact it has on the surrounding environment following dispersion in the air. Controls of the dispersion of the emission to air typically consider both the prevention of complaints as well as legal requirements associated with odour emissions and their composition, e.g. if they contain VOCs.

For example, reduced ground level concentrations could be achieved without any reduction in the magnitude of the odour emission, but merely by enhancing its dispersion in the air. Adding a perfumed component, i.e. a masking agent, is another option of physically treating the odour, but it is not recommended.

The dispersion of an exhaust emission in the air, and hence its resultant ground level odour concentration, will depend upon a variety of factors, including:

- the prevailing climatic conditions
- the height of the discharge
- positioning of nearby buildings or structures
- stack temperature (thermal buoyancy)
- stack discharge velocity
- configuration of the discharge stack.

With the exception of the prevailing climatic conditions, all of the above-mentioned factors can be altered with the desired intention of improving the dispersion potential of the discharge. The influence of the above factors can be examined in a computer-based dispersion model which incorporates these factors in the computation of ground level odour concentrations. The model allows the sensitivity of stack height or increases to the discharge velocity to be quantitatively judged in relation to resultant ground level concentrations.

This section and its sections make reference to the use of computer-based air dispersion models to identify optimum discharge conditions to minimise the ground level concentrations of odour. The models are not described in this document. There are also equations available to calculate optimum stack characteristics and these can be determined without using an expensive air dispersion model. These procedures can be used as a guideline and can, therefore, be used as an initial check to see whether increases to either the stack height or stack velocity are possible. The practicality of carrying out such changes, can also be assessed.

4.4.3.13.1 Extending the height of the discharge stack

Description

The effect of buildings or structures within the vicinity of the stack discharge can often cause poor dispersion and, in some cases, the phenomenon known as plume grounding, where the exhaust is pulled downwards under the influence of nearby structures. Air dispersion models can take account of the potential influence of these structures.

Achieved environmental benefits

Reduced perception of odour problems in the vicinity of the odour source.

Cross-media effects

Reduced visual amenity due to the presence of the chimney(s). The production and emission of the malodorous substance(s) has not been prevented or abated.

Operational data

This process is typically carried out using a correlation taking into account the height, width and length of the building. For example, in the “breeze computer model” as validated by the Environmental Protection Agency in the United States, a correlation is used that incorporates the height and maximum projected width of nearby buildings. The maximum projected width is defined as the diagonal distance (L) between extreme corners of the building at the maximum building elevation. The procedure is then to draw a radius of 5 x L from the building/structure. If the stack discharge falls within 5 x L of the nearby building/structure, then the presence of that building will likely have a negative impact on the dispersion from the nearby stack. Similarly, if the stack discharge is outside of the 5 x L radius then the building/structure will have no effect on the dispersion.

The procedure subsequently allows the user to determine the required stack height such that the stack is at a sufficient elevation not to be influenced by the building/structure. The procedure involves comparing the diagonal distance (L) with the building/structure height and the lesser of these two measurements is used in the following equation to determine the stack height required so as not to be influenced by the building/structure.

$$h_e = h_b = 1.5 \times L$$

Where:

h_e = required stack height

h_b = height of the building/structure

L = diagonal distance

This procedure can be used as a simple check to ascertain whether an existing stack discharge would be influenced by a nearby building/structure. The analysis indicates whether or not extensions to the stack height would be a viable option. In this respect, reference to any planning restrictions, in terms of maximum elevations, would need to be considered in addition to the need for, e.g. increased supporting structures.

Applicability

Applicable in all FDM installations with malodorous emissions which are not considered to be harmful, but only offensive.

Economics

Low cost technique.

Reference literature

[34, Willey A R and Williams D A, 2001]

4.4.3.13.2 Increasing stack discharge velocity

Description

The magnitude of the discharge velocity applied to a final emission to the air can have a significant effect on the resultant ground level impact of a malodorous emission. An increased discharge velocity will result in an increased momentum or buoyancy of the emission. This implies that the discharge will attain an increased elevation thereby allowing more potential for dispersion in the air and hence lower ground level concentrations.

Achieved environmental benefits

Reduced odour emissions.

Cross-media effects

Energy consumption.

Operational data

A typical design range for final discharge velocities from stacks is between 10 and 20 m/s, with an industry standard of 15 m/s. Design velocities of less than 10 m/s are likely to suffer from poor dispersion, whilst velocities above 20 m/s can prove expensive in terms of extraction fan power and operating costs. Furthermore, discharge velocities greater than 20 m/s can result in significant noise as the discharge generates a whistling phenomenon.

There may also be restrictions on the design velocity that can be applied to certain installations. In guidance documents, it is common for the discharge from a wet separation plant such as a water scrubber to be limited to no greater than 9 m/s. This restriction is designed to prevent the carryover of a significant quantity of water droplets resulting in a fountain effect.

The stack discharge velocity can be reduced significantly if there are physical restrictions in the discharge flowpath. Restrictions reduce the momentum of the plume during discharge. Many discharge stacks have a cone fixed over the outlet, designed to prevent rainfall entering the process via the discharge stack. The discharging process air is thus forced outwards through 90° rather than upwards, resulting in a considerable loss of available momentum. If the use of rainfall protectors is avoided, the stack design then needs to take account of rainfall and its collection.

Applicability

Applicable in all FDM installations.

Economics

Low cost technique.

Reference literature

[34, Willey A R and Williams D A, 2001]

4.5 End-of-pipe waste water treatment

Waste water treatment is an “end-of-pipe” treatment which is required because waste water is produced from various sources. These include water from vehicles; equipment and installation cleaning and from the washing of raw materials. Waste water also arises from, e.g. evaporation or drying of foods. WWTPs consume energy and produce residues which usually have to be disposed of.

Waste water treatment is applied after “process-integrated” operations have minimised both the consumption and the contamination of water.

Chapter 2 covers the processing unit operations used in the FDM sector, but does not include the unit operations used in end-of-pipe treatment techniques. In the following sections, general issues about FDM waste water and its treatment are introduced. The most commonly applied treatments are then described individually and this is followed by information about waste water treatment in some of the FDM sectors.

Techniques widely applicable in the FDM sector achieve environmental benefits such as waste minimisation and may achieve some or all of the following in relation to a specific waste water stream:

- reduction in the volume
- reduction in the strength
- elimination of, or decrease in, the concentration of certain substances
- increase in the suitability for recycling or re-use.

These techniques are discussed throughout this document. Some are applicable in the whole FDM sector and others are only applicable in individual unit operations or sectors.

Chapter 2 covers the processing unit operations used in the FDM sector but does not include the unit operations used in end-of-pipe treatment techniques. This section therefore covers the abatement techniques used to treat waste water discharges within the FDM sector. These techniques include those that may or may not be considered as BAT. Sections 4.5.2 to 4.5.6.1.5 inclusive, describe techniques generally used in most of the sectors. Sections 4.5.7 to 4.5.7.9 inclusive, describe their application in some of the individual sectors.

There are many factors which influence the choice of waste water treatment. The main factors are:

- volume and composition of waste water being discharged
- the local situation in terms of the receiver of the discharge, e.g. MWWTP, river, estuary, lake, sea and any discharge limits applied
- economics
- the removal of pollutants, including, e.g. dangerous substances as defined in Council Directive 76/464/EEC [206, EC, 1976] and priority hazardous substances as defined in Directive 2000/60/EC [207, EC, 2000].

4.5.1 Discharge of waste water from installations

When choosing a discharge option many factors are considered, including but not necessarily limited to:

- whether the waste water is clean or contaminated
- the availability of suitable space for on-site treatment
- the proximity and capacity of off-site WWTP(s)
- the proximity and characteristics of potential receiving waters
- the availability of other off-site treatment or disposal facilities
- on-site treatment costs versus off-site treatment/disposal costs
- the relative effectiveness, e.g. based on reduction of load, of on-site and off-site treatment
- the assessment of environmental risks associated with each option
- the disposal of secondary wastes arising from on-site treatment
- the ability to operate and maintain on-site treatment facilities
- negotiations with the permitting authority and/or WWTP operator and likely permit conditions
- projected trends in waste water volume and composition
- proximity of local residents.

The main options for discharging waste water from an installation are:

- to off-site, e.g. MWWTP without treatment
- to off-site, e.g. MWWTP after partial treatment
- to watercourse after full on-site WWTP
- off-site re-use of certain waste water streams, e.g. as a feed stream in another industry, or for irrigation
- off-site land application (see Section 4.1.6).

[13, Environment Agency of England and Wales, 2000]

Where it is essential for the installation to be close to the source of its raw material, i.e. in a remote location, there may be no alternative but to carry out full treatment and discharge to a local watercourse. In most cases, however, two or more options will merit detailed consideration. Waste water disposal may be a major factor in the choice of site for new installations.

The advantages of the treatment of individual waste water streams on-site are reported to be:

- more flexibility for increased production, or for reacting to changing conditions
- facilities for treatment at source are usually tailor-made and so normally perform well
- operators of the production units demonstrate a more responsible attitude towards waste water treatment when they are made responsible for the quality of their own waste water discharge.

The advantages of the treatment at a combined/mixed waste water on-site or off-site plant are reported as follows:

- making use of mixing effects, such as temperature or pH
- lower capital costs due to economy of scale
- more effective use of chemicals and equipment, thus decreasing relative operating costs
- dilution of certain contaminants which may be difficult to treat individually; e.g. emulsified fats and sulphates.

Where waste water is treated in an off-site WWTP, the above advantages apply, provided that:

- the treatment at the off-site WWTP is as good as would be achieved if treated on-site, particularly in terms of the load, but not the concentration, of each substance to the receiving water
- there is an acceptably low probability of the treatment plant being by-passed, via surface/emergency overflows, or at intermediate pumping stations
- there is a suitable monitoring programme in place for emissions to an off-site WWTP, taking into consideration the potential inhibition of any downstream biological processes.

[13, Environment Agency of England and Wales, 2000]

Additionally, the off-site WWTP may benefit by receiving the FDM waste water, e.g. because of its biodegradability.

4.5.1.1 Waste water treatment techniques applied

The descriptions of the various waste water treatment techniques in the following sections, show the sequence that the techniques typically follow to achieve progressively better quality waste water. Due to the nature of the raw materials used and the products produced, waste water arising from the FDM sector is primarily biodegradable in nature. However, cleaning and disinfection agents may represent a problem if they are poorly degradable. Table 4.44 shows the waste water treatment techniques described and Table 4.45 summarises their typical application in the FDM sector.

Code	Technique	Section
Primary treatments		
T1	Screening	see Section 4.5.2.1
T2	Fat trap for the removal of FOG and light hydrocarbons	see Section 4.5.2.2
T3	Flow and load equalisation	see Section 4.5.2.3
T4	Neutralisation	see Section 4.5.2.4
T5	Sedimentation	see Section 4.5.2.5
T6	DAF	see Section 4.5.2.6
T7	Diversion (emergency) tank	see Section 4.5.2.7
T8	Centrifugation	see Section 4.5.2.8
T9	Precipitation	see Section 4.5.2.9
Secondary treatments		
T10	Activated sludge	see Section 4.5.3.1.1
T11	Pure oxygen systems	see Section 4.5.3.1.2
T12	SBR	see Section 4.5.3.1.3
T13	Aerobic Lagoons	see Section 4.5.3.1.4
T14	Trickling filters	see Section 4.5.3.1.5
T15	Bio-towers	see Section 4.5.3.1.6
T16	RBC	see Section 4.5.3.1.7
T17	BAFF – SBAF	see Section 4.5.3.1.8
T18	High rate filters	see Section 4.5.3.1.9
T19	Anaerobic lagoons	see Section 4.5.3.2.1
T20	Anaerobic contact processes	see Section 4.5.3.2.2
T21	Anaerobic filters	see Section 4.5.3.2.3
T22	UASB	see Section 4.5.3.2.4
T23	IC reactors	see Section 4.5.3.2.5
T24	Hybrid UASB	see Section 4.5.3.2.6
T25	Fluidised and expanded bed reactors	see Section 4.5.3.2.7
T26	EGSB	see Section 4.5.3.2.8
T27	MBR	see Section 4.5.3.3.1
T28	Multistage systems	see Section 4.5.3.3.2
Tertiary treatments		
T29	Biological nitrification/denitrification	see Section 4.5.4.1
T30	Ammonia stripping	see Section 4.5.4.2
T31	Phosphorus removal by biological methods	see Section 4.5.4.3
T32	Dangerous and priority hazardous substances removal	see Section 4.5.4.4
T33	Filtration	see Section 4.5.4.5
T34	Membrane filtration	see Section 4.5.4.6
T35	Biological nitrifying filters	see Section 4.5.4.7
T36	Disinfection and sterilisation	see Section 4.5.4.8
Natural treatments		
T37	Integrated constructed wetlands	see Section 4.5.5.1
Sludge treatments		
T38	Sludge conditioning	see Section 4.5.6.1.1
T39	Sludge stabilisation	see Section 4.5.6.1.2
T40	Sludge thickening	see Section 4.5.6.1.3
T41	Sludge dewatering	see Section 4.5.6.1.4
T42	Sludge drying	see Section 4.5.6.1.5

Table 4.44: Some waste water treatment techniques

Emission type	Technique
Soluble organic material (BOD/COD)	T10, T11, T12, T13, T14, T15, T16, T17, T18, T20, T21, T22, T23, T24, T25, T26, T27, T32, T37
Total SS	T1, T5, T8, T9, T33, T34, T37
Acids/alkali	T3, T4
FOG (free)	T1, T2, T5, T6 ¹ , T8 ¹ , T9
FOG (emulsified)	T10, T12, T13, T14, T19, T20, T21, T28
Nitrogen ²	T10, T11, T12, T13, T14, T15, T16, T29, T30, T35, T37
Phosphorus	T9, T10, T12, T14, T15, T16, T31, T37
Dangerous and priority hazardous substances	T5, T9, T10, T14, T32
¹ Enhanced by using chemicals	
² Includes ammonia removal	

Table 4.45: The typical application of some waste water treatment techniques in the FDM sector [1, CIAA, 2002]

Waste water in the FDM sector has the following typical characteristics:

- solids (gross and finely dispersed/suspended)
- low and high pH level
- free edible fat/oil
- emulsified material, e.g. edible fat/oil
- soluble biodegradable organic material, e.g. BOD
- volatile substances, e.g. ammonia and organics
- plant nutrients, e.g. phosphorus and/or nitrogen
- pathogens, e.g. from sanitary waters
- heavy metals
- dissolved non-biodegradable organics.

After treatment, the waste water quality in Table 4.46 may be attained. For some sectors lower discharge levels may be possible. Information about some sectors is given in Sections 4.5.7 to 4.5.7.9 inclusive. Local conditions may require lower emission levels to be achieved.

Parameter	Concentration (mg/l)
BOD ₅	<25
COD	<125
TSS	<50
pH	6 – 9
Oil and grease	<10
Total nitrogen	<10
Total phosphorus	<5
Coliform bacteria	400 MPN/100 ml*
MPN = most probable number	
* Meat and dairy sectors	
Better levels of BOD ₅ and COD can be obtained. It is not always possible or cost effective to achieve the total nitrogen and phosphorus levels shown, in view of local conditions	

Table 4.46: Typical FDM waste water quality after treatment [140, World Bank (IBRD), et al., 1998]

Waste water produced in the various sectors can vary considerably in composition and pollution levels, and a variety of processes may be used to treat it. A summary of some methods used in different sectors is presented in Table 4.47. Combinations of processes are frequently used to treat heavily polluted waste water.

	Meat	Potato	Fruit and vegetable	Vegetable oil	Dairy	Starch	Confectionery	Sugar	Brewing	Malting	Soft and alcoholic drinks	Distilleries and spirits	Wine and sparkling wine
Primary treatments													
Screening	Yes	Yes	Yes		Yes	Yes	Yes		Yes	Yes	Yes	Yes	Yes
Sedimentation		Yes	Yes		Yes	Yes	Yes	Yes	Yes	Yes	Yes	Yes	
DAF	Yes	Yes		Yes	Yes	Yes	Yes				Yes		
Fat trap	Yes	Yes		Yes	Yes	Yes	Yes				Yes		
Centrifugation				Yes		Yes							
Flow and load equalisation	Yes		Yes	Yes	Yes	Yes	Yes	Yes	Yes	Yes	Yes		Yes
Precipitation				Yes	Yes	Yes	Yes			Yes	Yes		
Neutralisation			Yes	Yes	Yes	Yes	Yes		Yes		Yes	Yes	Yes
Secondary treatments													
Aerobic treatment	Yes	Yes	Yes	Yes	Yes	Yes	Yes	Yes	Yes	Yes	Yes		Yes
Anaerobic treatment	Yes	Yes	Yes	Yes	Yes	Yes	Yes	Yes	Yes	Yes	Yes	Yes	Yes
Activated sludge	Yes	Yes	Yes	Yes	Yes	Yes	Yes	Yes	Yes	Yes	Yes		Yes
Multistage activated sludge	Yes	Yes	Yes	Yes	Yes	Yes		Yes		Yes	Yes	Yes	
SBR	Yes*		Yes*	Yes	Yes	Yes**		Yes	Yes	Yes	Yes		Yes
Trickling filters	Yes	Yes	Yes			Yes***		Yes	Yes	Yes	Yes		Yes
Aerobic lagoons		Yes	Yes		Yes	Yes***		Yes	Yes	Yes	Yes	Yes	
Yes = treatment applied in that sector * Used in the Netherlands ** Anaerobic batch reactors *** In connection with anaerobic treatment													

Table 4.47: A summary of waste water treatment processes used in different sectors [65, Germany, 2002]

4.5.2 Primary treatments

In this document, the term **primary treatment** is used to describe what is sometimes described as primary treatment, preliminary treatment or pretreatment.

4.5.2.1 Screening (T1)

Description

After solids are removed with in-process techniques and prevented from entering the waste water, e.g. using catchpots located at drainage points inside the installation (see Sections 4.1.7.6, 4.3.1 and 4.3.1.1); further solids can be removed from the waste water using screening. Large quantities of non-emulsified FOG can be removed if screening is carried out together with technical and operational measures to avoid clogging.

A screen is a device with openings, generally of uniform size that is used to retain the coarse solids found in waste water. The screening element consists of parallel bars, rods or wires, grating or a wire mesh or perforated plate. The openings may be of any shape but are generally circular or rectangular slots. The spacing between bars for removing very coarse materials prior to finer screening, may be of 60 – 20 mm. To remove smaller particles, such as vegetable pieces and, e.g. peas and beans in a canned food factory, the spacing between bars generally does not exceed 5 mm. The openings in automatic screens range from 0.5 mm to 5 mm, with openings of 1 – 3 mm in widespread use. Smaller openings (1 – 1.5 mm) are reported to be less susceptible to blockage than larger ones (2 – 3 mm).

The main types of screens used are static (coarse or fine), vibrating and rotary screens.

Static screens, brushed or run-down, can comprise vertical bars or a perforated plate. This type of static screen requires manual or automatic cleaning.

Vibrating screens require rapid motion to be effective. They are normally used for primary treatments associated with by-product recovery, particularly of solids with a low moisture content and preferably where the waste water does not contain grease. Vibrating screens operate between 900 and 1800 rpm; the motion can either be circular, rectangular or square, varying from 0.8 – 12.8 mm total travel. The speed and motion can be selected according to the particular application. Of prime importance in the selection of a proper fine vibrating screen is the application of the correct combination of wire strength and percentage of open area. The capacities of vibrating screens are based on the percentage of open area of the screen media.

Rotary or drum screens receive the waste water at one end and discharge the solids at the other. The liquid is passed outward through the screen to a receiving box for forward transfer. The screen is usually cleaned by a continuous spray via external spray nozzles, which are inclined towards the solids discharge end. This type of screen is effective for streams containing a relatively high solids content. Microscreens mechanically separate solid particles from the waste water by means of microscopically fine fabrics. The most important operating parameter is the headloss, i.e. the loss of operating pressure, with the best separation results reported to be between 5 and 10 mbar.

Achieved environmental benefits

SS, FOG and BOD/COD levels reduced. Recovery of products, e.g. pulp in the fruit and vegetable sector. Reduced risk of odour emissions further downstream in the WWTP.

Cross-media effects

There may be odour emissions, depending on, e.g. the type and size of the solids screened.

Operational data

Table 4.48 shows the estimated pollution load reduction in the fish sector, when using rotary wedge wire screens.

Pollution load source	Reduction (%)
White fish waste water	10 – 20
Fatty fish waste water	30 – 40

Table 4.48: Estimated pollution load reduction in the fish sector, when using rotary wedge wire screens

In the fish sector, it has been reported that the removal of small solids is carried out using a filtration belt and vibrating screen with a filter mesh of 0.1 mm or less.

The blockage of screens is a common problem leading to the need for frequent cleaning. A **curved sieve** can be used to overcome blockages. This consists of a feeding device and a concave surface; and it is **self-cleaning** in operation. Wedge-shaped profiled rods are arranged perpendicularly to the flow direction of the water. A relatively steady overflow ensures that the screen cleans itself. The various screen segments are all interchangeable. Typical gap widths are 0.02 – 2 mm for sieve areas of 0.1 – 3.0 m² (maximum throughput 300 m³/m²/h). Curved screens are frequently used in fruit and vegetable factories. Alternatively, **rotary screens** equipped with self-cleaning may be used. When the blockage is due to fatty deposits, e.g. in the meat, dairy and fish sectors, regular chemical cleaning and/or hot water cleaning can be applied.

Applicability

Applicable in all FDM installations.

Economics

Screening removes the need for, and therefore the cost of, additional waste water treatment. It reduces the amount of sludge produced, which would otherwise require additional expenditure for its disposal.

Driving force for implementation

Reduced waste water treatment requirements.

Example plants

Used in the meat, fruit and vegetable, fish, drinks and vegetable oil sectors.

Reference literature

[28, Nordic Council of Ministers, 1997, 65, Germany, 2002, 134, AWARENET, 2002]

4.5.2.2 Fat trap for the removal of FOG and light hydrocarbons (T2)

Description

If FOG is not removed prior to aerobic biological treatment, it may hinder the operation of the WWTP as it is not easily degraded by bacteria. Free FOG may be separated from water using a fat trap (grease interceptor). Similar equipment is used to separate light hydrocarbons.

A further development of the fat trap is the parallel-plate separator. Here, the separator chamber contains plates inclined at an angle of 45°. The EU standardisation of separators for oils, fats and light hydrocarbons is currently ongoing (prEN 1825 and prEN 858, Parts 1 and 2).

Achieved environmental benefits

Removal of free FOG from the waste water. The system does not usually require any chemical additions so the recovered fats may be re-used.

Cross-media effects

Depending on the type of fat trap, e.g. without continuous fat removal, there may be odour emissions, particularly during emptying.

Installing fat traps within processing areas can cause food safety problems. Excessively hot water can cause fats to carry through and may melt pre-collected fat, so it should be avoided. The baffle material and ease of cleaning need to be considered.

The correct sizing of chambers is critical to ensure proper separation and to avoid the danger of washout during high or abnormal flows. Flow diversion may be needed if inflows suffer large fluctuations. Ease of emptying and regular maintenance is essential to prevent odour problems.

Operational data

The efficiency of separation depends on the water temperature and is increased if the water temperature is low. The presence of emulsifiers can also reduce the separation efficiency. It has been reported that an efficiency of 95 %, related to the free oil/fat content, can be achieved.

In the vegetable oils and fats sector, it has been reported that parallel plate separators are very sensitive to clogging.

Applicability

Applicable in FDM installations with waste water containing animal and vegetable FOG.

Economics

The investment required is reportedly outweighed by the savings in waste water treatment costs and plant maintenance.

Driving force for implementation

Reduction in problems caused by fat in waste water pipelines and WWTPs, and reduced loads require treatment.

Example plants

Used in the meat and vegetable oils and fats sectors.

Reference literature

[65, Germany, 2002, 182, Germany, 2003, 185, CIAA-FEDIOL, 2004, 210, Brechtelsbauer P.,]

4.5.2.3 Flow and load equalisation (T3)

Description

Equalisation tanks or buffer storage are normally provided to cope with the general variability in flow and composition of waste water, or to provide corrective treatment, e.g. pH control or chemical conditioning. The need to equalise waste water discharges may need to be considered to ensure that the flow and composition of the waste water are within the design parameters of the WWTP.

Achieved environmental benefits

Enables downstream treatment techniques to operate at the optimum efficiency. Makes use of mixing effects to offset extremes of temperature or pH.

Cross-media effects

Excessive retention of waste water in the equalisation tank may lead to acidity and odour.

Operational data

Adequate mixing and aeration is needed to minimise the formation of scum on the surface of the equalisation tank and to maintain a sufficient dissolved oxygen level to ensure the contents do not become anaerobic, leading to acidity and odour. Nevertheless, where necessary, scum removal equipment is installed. Equalisation tanks typically have a retention time of 6 - 12 hours.

Applicability

Widely applicable in the FDM sector.

Economics

The cost of constructing and operating an equalisation tank needs to be compared with the cost savings associated with the smooth running of the downstream treatment techniques.

Driving force for implementation

To present a virtually homogeneous feed to downstream WWTP processes.

Example plants

Equalisation tanks are used in the meat, fruit and vegetable, starch, dairy, soft and alcoholic drinks and vegetable oils and fats sectors.

Reference literature

[1, CIAA, 2002, 13, Environment Agency of England and Wales, 2000]

4.5.2.4 Neutralisation (T4) and self-neutralisationDescription

The objective of neutralisation is to avoid the discharge of strongly acid or alkaline waste water. It can also protect downstream waste water treatment processes.

The following are normally used to neutralise waste water which has a low pH:

- limestone, limestone slurry or milk of lime (hydrated lime $\text{Ca}(\text{OH})_2$)
- caustic soda (NaOH) or sodium carbonate (Na_2CO_3)
- ion exchangers (cationic).

The following are normally used to neutralise waste water which has a high pH:

- introduction of CO_2 , e.g. flue-gas and gas from fermentation processes
- sulphuric acid (H_2SO_4) or hydrochloric acid (HCl)
- ion exchangers (anionic).

The term self-neutralisation is used when, in some cases, the size of the equalising tank, in combination with suitable variations in the pHs of the waste water streams, means that no addition of chemicals is required. This can occur, e.g. in some dairies where both acid and alkaline cleaning solutions are used and are both sent to the neutralisation tank.

Achieved environmental benefits

Avoids the effects of strongly acidic or strongly alkaline waste water, i.e. corrosion, reduction on the efficiency of biological treatments and/or a reduction in the self-purifying properties of lakes and rivers, and possibly operating problems for other water users.

Cross-media effects

Due to the addition of chemicals to the waste water, the dissolved solids/salt content may increase significantly in the treated water and the solid waste produced might be difficult to dispose of.

Operational data

It has been reported that in the brewery sector, the neutralisation can take place in production areas or in central neutralisation tanks with acid or caustic. The neutralisation of process waste water requires a tank with a hydraulic retention time of approximately 20 minutes. The mixing capacity should be sufficient to keep the tank completely mixed. Since both caustic and acidic cleaning agents are used at the breweries, a reduction in chemical usage for neutralisation can be obtained by increasing the hydraulic retention time in the neutralisation tank. Neutralisation tanks are often also used as equalisation tanks (see Section 4.5.2.3) with a hydraulic retention time of 3 – 6 hours.

Furthermore, partial neutralisation through **biological conversion** will normally take place in process waste water from the brewery sector. It has been observed that the pH in equalisation tanks can drop without the addition of acids due to the hydrolysis of organic material. The effect is difficult to control but it reduces the dosing requirements of acid to caustic process waste water. To achieve biological acidification, a hydraulic retention time of 3 – 4 hours is required.

Applicability

Applicable in installations with strongly acidic or alkaline waste water.

Example plants

Neutralisation is used in the fruit and vegetable, dairy, brewery and drinks sectors.

Reference literature

[9, Verband der Deutschen Milchwirtschaft (German Dairy Association), 1999, 65, Germany, 2002]

4.5.2.5 Sedimentation (T5)

Description

Sedimentation is the separation from water, by gravity settling, of suspended particles that are heavier than water. The settled solids are removed as sludge from the bottom of the tank, or periodically after the removal of water.

The equipment used for sedimentation can be either:

- rectangular or circular tanks equipped with the appropriate scraper gear (top scraper for FOG removal, and a bottom scraper for solids removal) and sufficient capacity to provide adequate residence time for separation to occur
- laminar or tube separators where plates are used to increase the surface area for separation.

Achieved environmental benefits

Reduction of SS and FOG levels. Reduction of the waste produced, e.g. in the starch sector, sludges might be recoverable as a by-product for possible animal feed. Sedimentable and floatable dangerous and priority hazardous substances levels are reduced.

Operational data

It has been reported that in the fish sector, up to 35 % of the solids present can be removed by sedimentation.

Table 4.49 shows the typical performance data of the brewery sector after sedimentation.

Initial load (m ³ /m ² /h)	Final SS (mg/l)
0.5 – 1.0	20 – 30
The acceptable loading will depend on the sedimentation characteristics of the sludge	

Table 4.49: Typical performance data of the brewery sector after sedimentation

The advantages and disadvantages of sedimentation are shown in Table 4.50.

Advantages	Disadvantages
Simplicity of installation, not liable to fail	Rectangular or circular tanks may occupy large surface areas
	Unsuitable for finely dispersed material
	Laminar separators may be prone to blockage with fat

Table 4.50: Advantages and disadvantages of sedimentation

In the sugar sector, the fluming or transport water contains mud, stones and waste vegetation, as well as high COD from damaged sugar beet. The heavy dust requires sedimentation. The use of large sedimentation ponds has been reported. The sludge taken from the settlement ponds can be further dewatered and the liquors recovered from the dewatering process can be returned to the factory, either via the diffusers or as fluming water.

Applicability

Applicable in FDM installations with waste water containing SS. The application of this technique may be restricted due to space requirements.

Economics

Waste water treatment charges generally make it cost effective for most installations covered by IPPC to carry out some sort of separation of SS. Compared to DAF, sedimentation has higher capital costs but lower operating costs.

Example plants

Used in the fish, fruit and vegetable, starch, soft and alcoholic drinks and vegetable oils and fats sectors.

Reference literature

[13, Environment Agency of England and Wales, 2000, 65, Germany, 2002, 136, CBMC - The Brewers of Europe, 2002]

4.5.2.6 Dissolved air flotation (DAF) (T6)

Description

The separation of materials lighter than water, e.g. edible oil/fat, can be enhanced by using flotation. In the FDM sector, DAF is mostly used. This technique decreases the retention time but does not enable the separation of emulsified FOG from water and, therefore, is used widely in the FDM sector for the removal of free FOG.

The basic mechanism of DAF is the introduction of small air bubbles into the waste water containing the suspended solids to be floated. The fine air bubbles attach themselves to the chemically conditioned particles and as they rise to the surface, the solids float to the surface with them.

The air is dissolved under pressure 300 – 600 kPa (3 – 6 bar). The air is normally introduced into a recycle stream of treated waste water which has already passed through a DAF unit. This supersaturated mixture of air and waste water flows to a large flotation tank where the pressure is released, thereby generating numerous small air bubbles. Here they are accumulated, thickened and removed by mechanical skimming or suction withdrawal. Chemicals such as polymers, aluminium sulphate or ferric chloride can be used to enhance flocculation and therefore, the adhesion of bubbles. DAF equipment is similar to that used for sedimentation (see Section 4.5.2.5).

Achieved environmental benefits

Free FOG, BOD/COD, SS, nitrogen and phosphorus levels are reduced. Reduction of the waste produced, e.g. the sludges might be recoverable as a by-product, e.g. in the meat and dairy sectors they are used for animal feed. The system is kept aerobic, so the risk of odour problems is low.

Operational data

Table 4.51 shows the removal efficiency of DAF in a herring filleting installation.

Parameter	Reduction (%)
COD	70 – 75
BOD	80*
Total nitrogen	45*
Total phosphorus	70 – 85
Oil	85*
Grease	98*
*Approximate figure DAF is used when the free FOG content is high	

Table 4.51: Removal efficiency of DAF in a herring filleting installation

During DAF, the pressurisation system may be prone to blockage problems.

Typically, sludges recovered from a DAF cell would be in the region of 3 – 4 % dry solids content. For the sludges to be recovered, coagulants and flocculants either have to be avoided or suitable substances chosen.

Applicability

Widely applicable in the FDM sector.

Economics

Waste water treatment charges generally make it cost effective for most installations covered by IPPC to carry out some sort of separation of SS. Compared to sedimentation, DAF has lower capital costs but higher operating costs.

Driving force for implementation

Compared to sedimentation; DAF requires less land, has higher separation efficiency and can absorb shock loads.

Example plants

Used in the meat, fish, fruit and vegetable, dairy, soft and alcoholic drinks and vegetable oils and fats sectors.

Reference literature

[13, Environment Agency of England and Wales, 2000, 28, Nordic Council of Ministers, 1997, 65, Germany, 2002]

4.5.2.7 Diversion (emergency) tank (T7)

Description

Contingency measures can be provided to prevent accidental discharges from processes damaging the WWTP and/or the operation of the MWWTP, by them receiving a sudden high load. A diversion tank capable of receiving typically 2 – 3 hours of peak flow can be established. The waste water streams are monitored upstream of the WWTP so that they can be automatically sidetracked to the diversion tank if necessary. The diversion tank is linked back to the equalisation tank (see Section 4.5.2.3) or primary treatment stage so that out-of-specification liquors can be gradually introduced back into the waste water stream. Alternatively, provision can be made to allow the disposal of the diversion tank contents off-site. Diversion tanks are also applied where there is no separate drainage system for surface water and it could enter the on-site WWTP.

Achieved environmental benefits

Avoids uncontrolled and untreated discharges of waste water.

Applicability

Widely applicable in the FDM sector.

Example plants

Used in the meat, dairy and soft and alcoholic drinks sectors.

4.5.2.8 Centrifugation (T8)Description

There are four main types of centrifuge available. The **solid bowl and basket centrifuges** dewater in a batch process. The solid bowl configuration relies on the supernatant liquors to either be scraped from the surface or over-top a weir arrangement at the top of the centrifuge. The basket system uses a perforated mesh, so that the liquid phase passes through the screen medium during centrifugation. The **disc-nozzle centrifuge** is primarily used for liquid/liquid separation. Finally, the **decanter centrifuge** is a standard technology widely used for activated sludge separation. Centrifuges can be used to separate particles too small to sediment, due to the greater gravitational forces applied.

Achieved environmental benefits

Reduction of SS, FOG and BOD/COD levels. Less waste produced, e.g. starch recovery in potato processing.

Cross-media effects

High energy consumption.

Operational data

Table 4.52 shows the removal efficiency of centrifugation in the herring industry.

Parameter	Reduction (%)
COD – from strongly polluted waste water	45
COD – from less polluted waste water	16 – 25
SS	80

Table 4.52: Removal efficiency of centrifugation in the herring industry

Applicability

Widely applicable in the FDM sector, e.g. for thickening or dewatering waste activated sludges. The application of centrifuges as a primary treatment technique is rather limited.

Economics

Maintenance and energy costs can be substantial, therefore, it is not attractive for installations with relatively low flows.

Example plants

Used in the fish, fruit and vegetable and soft and alcoholic drinks sectors.

Reference literature

[1, CIAA, 2002, 3, CIAA, 2001, 28, Nordic Council of Ministers, 1997, 145, Metcalf & Eddy, 1991, 159, CIAA-CEFS, 2003]

4.5.2.9 Precipitation (T9)Description

When solid particles cannot be separated by simple gravitational means, e.g. when they are too small, their density is too close to that of water or when they form colloids/emulsions, precipitation can be used. This technique converts the substances dissolved in the water into insoluble particles by means of a chemical reaction. Precipitation may also be used for phosphorus removal.

This process consists of three major parts. The first stage is **coagulation**, which is carried out to destabilise the colloidal/emulsion system by reducing the potential responsible for the system stability. This is generally undertaken by dosing with inorganic chemicals such as aluminium sulphate, ferric chloride, or lime. The next step is the **flocculation** of small particles into larger ones, which can be readily settled or floated. This may involve the addition of polyelectrolytes to form bridges to produce large flocs. Apart from coagulation-flocculation some precipitation of metal hydroxides occurs and these hydroxides **adsorb** particles of fat. Following precipitation, sludges are removed by either sedimentation (see Section 4.5.2.5) or DAF (see Section 4.5.2.6).

Achieved environmental benefits

Reduction of SS, FOG and phosphorus levels. If dangerous and priority hazardous substances are used in the production process, their levels in the waste water are reduced.

Cross-media effects

Due to the addition of chemicals to the waste water, the dissolved solids/salt content may increase significantly and the solid waste produced might be difficult to re-use or dispose of.

Operational data

Phosphorus removal efficiencies of 70 – 90 % have been reported using precipitation. In the dairy sector, a higher sludge production has been reported when using precipitation of phosphate to remove phosphorus. Precipitation is reported to be easier to manage than biological removal of phosphorus.

The elimination of phosphorus from edible oil refinery waste water can be a problem. In the untreated waste water, phosphorus is present in inorganic and organic form. The organic phosphorus compounds do not react with inorganic flocculants for precipitation. Precipitation by, e.g. aluminium salts, can, after biological degradation of the organics, achieve final discharge levels of less than 4.5 g/t unrefined oil.

Chemical treatment plants are difficult to operate as their performance is very susceptible to changing waste water characteristics so they are difficult to automate and require significant operator manpower.

The choice of chemicals used for coagulation and flocculation will depend upon the intended disposal route for the sludges.

If precipitation is applied simultaneously with activated sludge waste water treatment, it is reported that it aids the settling of the activated sludge. It is reported that in some cases the addition of phosphorus makes it more valuable for agricultural use, but in others such use would add to eutrophication problems. The phosphorus removal performance data from an activated sludge and simultaneous precipitation WWTPs from five Finnish potato starch installations are shown in Table 4.53.

Influent total-P level (mg/l)	30 – 90
Effluent total-P level (mg/l)	1 – 2
Activated sludge load 0.1 - 0.3 kg BOD/m ³ d	

Table 4.53: Phosphorus removal performance data of an activated sludge and simultaneous precipitation WWTPs in the potato starch sector

Applicability

Applicable in all FDM installations, e.g. to remove SS, FOG and phosphorus. In the fish sector, this technique is used when the oil content of the waste water is low. It is used in the fruit and vegetable sector to remove phosphorus with alumina or iron salts.

This technique may also be applied simultaneously during secondary treatment, e.g. in the activated sludge process, or as a tertiary treatment.

Economics

This technique produces solid waste which is expensive to dispose of.

Example plants

Used in the fish, fruit and vegetable, soft and alcoholic drinks and vegetable oils and fats sectors.

Reference literature

[65, Germany, 2002, 199, Finland, 2003]

4.5.3 Secondary treatments

Secondary treatment is directed principally towards the removal of biodegradable organics and SS using biological methods. Adsorption of pollutants to the organic sludge produced will also remove non-biodegradable materials, e.g. heavy metals. Organic nitrogen and phosphorus can also be partially removed from the waste water. Secondary treatment options can be used alone or in combination, depending on the characteristics of the waste water and the requirements before discharge. When they are applied in combination arranged in series, the technique is called **multistage systems** (see Section 4.5.3.3.2).

There are essentially three types of metabolic processes, i.e. aerobic processes, using dissolved oxygen; anaerobic processes, without oxygen supply and anoxic processes, using biological reduction of oxygen donors [1, CIAA, 2002, 13, Environment Agency of England and Wales, 2000, 65, Germany, 2002]. This section will describe techniques that use mainly aerobic and anaerobic metabolic processes.

The main advantages and disadvantages of anaerobic waste water treatment processes, compared to aerobic processes are shown in Table 4.54.

Advantages	Disadvantages
Low specific surplus sludge production; the lower growth rates mean lower macro/micro nutrient requirements	Mesophilic bacteria, which thrive at 20 – 45 °C, may require an external source of heat
Low energy requirements due to lack of forced ventilation	Low growth rate requires good biomass retention
Generally lower capital and running costs per kg COD removed. These are associated with a decreased in sludge production and lower mixing costs	Initial commissioning/acclimatisation phase can be long (Not for reactors with granular sludge, e.g. EGSB, seeded with the sludge of operating plants)
Produces biogas that can be used for power or heat generation	Anaerobic systems are more sensitive than aerobic systems to fluctuations in temperature, pH, concentration and pollution loads
Small space requirements	Some constituents of treated waste water can be toxic/corrosive, e.g. H ₂ S
Can be easily decommissioned for extended periods and remain in a dormant state (useful for seasonal manufacturing processes, e.g. sugar beet)	
A particular advantage of the process is the formation of pellets. This permits not only rapid reactivation after month-long breaks in operation, but also the sale of surplus sludge pellets, e.g. for the inoculation of new systems	
Some substances that cannot be degraded by aerobic means can be degraded anaerobically, e.g. pectin and betaine	
Less odour problems, if appropriate abatement techniques are employed	
No aerosol formation, can assimilate FOG (not for UASB)	

Table 4.54: Advantages and disadvantages of anaerobic waste water treatment compared to aerobic treatment

[1, CIAA, 2002, 13, Environment Agency of England and Wales, 2000, 65, Germany, 2002]

4.5.3.1 Aerobic processes

Aerobic processes are only generally applicable and cost effective when the waste water is readily biodegradable. Micro-organisms in the mixed liquor can receive the oxygen input from either the surface or from diffusers submerged in the waste water. Surface injection of oxygen is carried out by means of either surface aerators or oxygenation cages.

The advantages and disadvantages of aerobic waste water treatment processes are shown in Table 4.55.

Advantages	Disadvantages
Degradation into harmless compounds	Large quantities of sludge produced
	Stripping results in fugitive releases that may cause odours/aerosols
	Bacterial activity is reduced at low temperatures. Nevertheless, surface aeration and the injection of pure oxygen can be used to enhance the process
	If FOG is not removed prior to aerobic biological treatment, it may hinder the operation of the WWTP as it is not easily degraded by bacteria

Table 4.55: Advantages and disadvantages of aerobic treatment processes

[1, CIAA, 2002, 13, Environment Agency of England and Wales, 2000, 65, Germany, 2002]

4.5.3.1.1 Activated sludge (T10)

Description

The activated sludge technique produces an activated mass of micro-organisms capable of stabilising a waste aerobically. The biomass is aerated and maintained in suspension within a reactor vessel. Plants can use air, oxygen or a combination of the two. When they use oxygen they are called pure oxygen systems (see Section 4.5.3.1.2).

Achieved environmental benefits

Reduced BOD/COD, phosphorus and nitrogen levels. If dangerous and priority hazardous substances are used in the production process, its waste water levels are reduced.

Cross-media effects

High energy consumption.

Operational data

After a given residence time, which can vary from several hours to an excess of 10 days, based on an organic loading rate or F/M ratio of about 0.1 – 0.15 kg BOD/kg MLSS per day, the mixed suspension of micro-organisms is passed to a sedimentation facility (see Section 4.5.2.5). The hydraulic retention time or sludge age and F/M ratio can all vary as a function of the raw waste water characteristics, e.g. composition, availability and degradability of organic substances, and the required final waste water quality. For example, nitrification occurs with lower (<0.1 kg BOD/kg MLSS per day) F/M ratios. In the sedimentation facility, the settlement of microbial flocs occurs and clear waste water is passed over a weir to a watercourse. Settled sludge is produced and mostly returned to the aeration tank. However, a proportion, i.e. the excess sludge, is wasted to maintain MLSS at a reasonable level, e.g. 3000 mg/l.

The performance data of an activated sludge WWTP in the brewery sector is shown in Table 4.56.

Initial load (kg COD/m³ per day)	1.2 – 1.8
Final BOD level (mg/l)	15 – 25
Sludge generated per kg of BOD removed (SS/kg)	0.45 – 0.55
These performance figures are valid at a temperature range of 25 – 35 °C and thus not applicable during winter	

Table 4.56: Performance data of an activated sludge WWTP reported for the brewing sector

Phosphorus removal efficiencies of 10 – 25 % have been reported using activated sludge.

In the sugar sector, it has been reported that low winter air and water temperatures depress the treatment capacity as bacterial activity is reduced. However, low grade waste heat from the sugar process can usually be used to increase temperatures in the system and enhance bacterial activity.

The most common problem associated with activated sludge is that of bulking. This term is used to describe biological sludge of poor settling characteristics. It is generally due to the presence of filamentous bacteria and/or excessive water bound within biological floc. One important and fundamental point to emphasise regarding bulking sludge is that prevention is better than a cure. It is reported that a typical cure for bulking is the use of chemicals, i.e. chlorination, use of other oxidative chemicals or precipitation chemicals, to kill all filamentous organisms that are not protected by activated sludge flocs. These curing methods are reportedly not very selective and can destroy the whole biological activity.

Bulking can be prevented by, e.g. ensuring that the optimum balance of added nutrients is maintained, minimising both the release of nutrients and the overproduction of filamentous bacteria. Procedures to deal with bulking when it occurs, include reducing the load. The presence of ammonia as a breakdown product, provides evidence of the levels and shows whether denitrification is needed. The hydraulic residence time, the sludge age, and the operating temperature are the most important parameters to consider. The parameters need to be justified in terms of the breakdown of the more resistant organic substances.

In addition, the use of a separate compartment or selector has been recognised as a good tool to prevent and control filamentous growth. This is an initial contact zone where the primary waste water and the returned sludge are combined. The selector involves the selective growths of floc-forming organisms by providing high F/M ratios at a controlled dissolved oxygen level. The contact time is short, generally 10–30 minutes. The anoxic selector, which requires the presence of nitrate in the water, is often the choice for activated sludge systems that nitrify. In addition to providing an effective control of filamentous bacteria, anoxic selectors provide the benefits of reducing process oxygen requirements, since nitrate-nitrogen is used as a terminal electron acceptor for the oxidation of influent biodegradable organic matter, and reducing the consumption of alkalinity during nitrification, as a result of recovery of the alkalinity in the anoxic zone. Anoxic selectors can also be quite effective in controlling filament growth because they use both kinetic and metabolic selection mechanisms.

In the dairy sector, sludge-bulking has been reported in activated sludge systems with fluctuating loads and low F/M ratios, e.g. insufficient BOD. If a selector is not used, the final sedimentation needs to be designed according to the inferior sludge settling characteristics.

Applicability

Widely used in the FDM sector. The technique can be used to treat high or low BOD waste water, but will treat low BOD water highly efficiently and cost effectively. The application of this technique may be restricted due to space requirements.

Economics

The activated sludge technique provides a cost effective treatment of soluble organic matter. Nevertheless, it is better if the waste water from the starch sector, with a COD level higher than 10000 mg/l, is best not subjected to aerobic treatment alone.

In the soft and alcoholic drinks sector, due to the seasonal variation of the waste water, the application of the technique is usually over-dimensioned, with the corresponding high investment and operating costs.

Example plants

Used in the meat, fish, fruit and vegetable, starch, dairy, brewing, sugar, soft and alcoholic drinks and vegetable oils and fats sectors.

Reference literature

[65, Germany, 2002, 136, CBMC - The Brewers of Europe, 2002, 145, Metcalf & Eddy, 1991, 199, Finland, 2003]

4.5.3.1.2 Pure oxygen systems (T11)

Description

Pure oxygen systems are essentially an intensification of the activated sludge process, i.e. the injection of pure oxygen into an existing conventional aeration plant. This is often undertaken after increased or variable plant production which has rendered the aeration plant ineffective, for at least some part of its operational cycle.

Achieved environmental benefits

Reduction of BOD/COD and nitrogen levels. Reduced odour potential as the surface of the aeration tank is essentially unbroken. Reduced energy use.

Operational data

Compared to conventional activated sludge, pure oxygen systems have the ability to intensify the process by operating at a higher MLSS level. Furthermore, this technique uses less energy since in conventional activated sludge, 70 % of the energy is wasted due to the nitrogen occupying 70 % of the air by volume.

Applicability

Widely applicable in the FDM sector. As well as in new installations, a number of pure oxygen retrofits have been made in the FDM sector.

Economics

Since the system is operating at extremely long sludge ages and encouraging endogenous respiration, whereby the biomass ingests itself, there is a significant reduction of sludge disposal costs. Nevertheless, plants that use oxygen instead of air, have higher operational costs.

Driving force for implementation

The use of pure oxygen improves control and performance and can be retrofitted to existing plants.

Example plants

Used in the meat, fruit and vegetable, dairy and sugar sectors.

Reference literature

[13, Environment Agency of England and Wales, 2000]

4.5.3.1.3 Sequencing batch reactors (SBR) (T12)Description

The SBR is a variant of the activated sludge process. It is operated on the fill and draw principle and normally consists of two identical reaction tanks. The various stages of the activated sludge processes are all carried out within the same reactor.

Achieved environmental benefits

Reduction in BOD/COD, phosphorus and nitrogen levels.

Operational data

The process is very flexible as a number of process changes are possible within the operating cycles, e.g. enhanced denitrification during the idle phase. A typical total cycle period is about six hours. The time taken for each stage of the process can be adjusted to suit local circumstances. Finally, the process sequence is independent of any influences caused by hydraulic input fluctuations. In this sense, SBR has a simpler and more robust operation, i.e. fill and draw system rather than conventional activated sludge.

Since the batch wise filling leads to the formation of a readily settling activated sludge, this process is suitable for industrial waste waters that have a tendency towards bulking sludge

The typical operation of a typical SBR is shown in Table 4.57.

Step	Purpose	Operation (aeration)	Maximum volume (%)	Cycle time (%)
Fill	Add substrate	Air on/off	25 – 100	25
React	Biological degradation	Air on/cycle	100	35
Settle	Clarify	Air off	100	20
Draw	Remove waste water	Air off	35 – 100	15
Idle*	Waste sludge	Air on/off	25 – 35	5

*Waste sludge may occur in other steps as well. In multitank systems, the idle phase is used to provide time for the second tank to be filled. This step may be omitted

Table 4.57: Characterisation of a typical SBR

Applicability

Applicable in all FDM installations; the application of this technique may be restricted due to space requirements. This technique can be used to treat high or low BOD waste water, but will treat low BOD waste water very efficiently and cost effectively.

Economics

Lower capital and higher operational costs than conventional activated sludge.

Example plants

Used in the meat, fruit and vegetable, dairy, vegetable oils and fats, and soft and alcoholic drinks sectors.

Reference literature

[1, CIAA, 2002, 65, Germany, 2002, 145, Metcalf & Eddy, 1991]

4.5.3.1.4 Aerobic lagoons (T13)

Description

Aerobic lagoons are large shallow earthen basins that are used for the treatment of waste water by natural processes. They involve the use of algae, bacteria, sun and wind. Oxygen, in addition to that produced by algae, enters the liquid through atmospheric diffusion. The contents of the lagoons are normally mixed periodically using pumps or surface aerators.

A variation on the aerobic lagoon is the facultative lagoon, where stabilisation is brought about by a combination of aerobic, anaerobic and facultative bacteria. Oxygen can be maintained in the upper layer of a facultative lagoon by surface re-aeration.

Achieved environmental benefits

Reduced BOD and nitrogen levels.

Cross-media effects

Potential odour nuisance, soil deterioration and groundwater contamination.

Operational data

It has been reported that lagoons provide buffer capacity due to large areas and volumes; volume and concentration equalisation in seasonal operations and that they establish adapted biocoenoses given very long residence times. Depending on the soil characteristics, lagoons may need to be sealed, to avoid groundwater contamination.

In the sugar sector, it has been reported that surface area and depth are key elements in the rate of degradation of BOD. Degradation of BOD relies on natural processes such as the carbon, nitrogen and sulphur cycles, and the action of the bacteria. Furthermore, surface aeration is used in this sector to increase the rate of aerobic bacterial activity when needed, e.g. at low temperatures. Additional oxygen is diffused into the water by electrically driven “free” or “fixed” floating aerators. Occasionally, wind powered aerators are used where weather conditions are favourable. Mixed wind and electrical systems are available.

In wineries and olive oil mills, the use of evaporation lagoons has been reported. The waste water is left to evaporate in open basins for months.

Applicability

Applicable in all FDM installations; the application of this technique may be restricted due to space requirements. This technique can be used to treat high or low BOD waste water, but will treat low BOD water highly efficiently and cost effectively.

In the fruit and vegetable sector, lagoons are used provided they have adequate capacity to prevent uncontrolled overflows and to enable a controlled discharge of waste water during high flow periods.

Example plants

Lagoons are widely used in the sugar, fruit and vegetable, soft and alcoholic drinks and vegetable oils and fats sectors.

Reference literature

[65, Germany, 2002, 159, CIAA-CEFS, 2003, 199, Finland, 2003]

4.5.3.1.5 Trickling filters (T14)Description

In fixed film aerobic processes such as trickling filters, the biomass grows as a film on the surface of packaging media and the waste water is distributed so as to flow evenly across it.

The trickling filter medium normally consists of rocks or various types of plastic. The treated liquid is collected under the media and passed to a settling tank from where part of the liquid can be recycled to dilute the strength of the incoming waste water. Variations include alternating double filtration or permanent double filtration.

Achieved environmental benefits

Reduction in BOD/COD, phosphorus and nitrogen levels. If dangerous and priority hazardous substances are used in the production process, its waste water levels are reduced.

Cross-media effects

Potential odour nuisance.

Operational data

It has been reported that in the dairy sector, high rate trickling filters are typically designed to remove 50 – 60 % BOD. For an efficient operation, it is essential that FOG levels are minimised prior to being fed into the high rate filter. Following high rate filtration, secondary sedimentation may be required, depending upon the consent to discharge conditions. In the soft and alcoholic drinks sector, this technique is reported to be 70 % effective, so a further polishing step is normally needed.

Phosphorus removal efficiencies of 8 – 12 % have been reported using trickling filters.

Applicability

Applicable for waste water with a relatively low BOD, or as a polishing stage after an activated sludge process or high rate filtration. Its use within the FDM sector has decreased because of the relatively large land area it requires and because of operational problems due to blockage.

Example plants

Used in the fish, dairy, soft and alcoholic drinks and vegetable oils and fats sectors. High rate trickling filters have been used at some dairies in the UK.

4.5.3.1.6 Bio-towers (T15)Description

Waste waters from the processing of FDM often have an organic strength too high for conventional aerobic treatment. Consequently, treatment is necessary to reduce the BOD to an acceptable level prior to further treatment, e.g. at a MWWTP. Bio-towers or roughing filters are specially designed trickling filters (see Section 4.5.3.1.5) operated at high organic loading rates that can achieve high levels of BOD removal.

The technique uses aboveground tanks containing plastic media with a high surface area. Microbial film adheres to the media and consumes the organic material. The waste water is often recycled over the bio-tower to achieve a further treatment. The waste water from these units is then discharged to a conventional biological process.

Achieved environmental benefits

Reduced BOD/COD, phosphorus and nitrogen levels.

Cross-media effects

Potential odour nuisance. Noise emissions. SS may be created.

Operational data

Plastic media of the type used in bio-towers has a surface area ratio of 100 – 240 m²/m³. Loading rates of 0.5 kg BOD/m³/day have been reported to achieve over 90 % removal; up to 60 % removal is possible with loadings of 2.5 kg BOD/m³/day. Blockage and unstable sludge might occur. Noise may arise from blowing air into the bio-tower.

Applicability

Applicable in all FDM installations with high organic strength waste water.

Driving force for implementation

Bio-towers are an effective method for reducing BOD to something closer to that of domestic sewage.

Reference literature

[1, CIAA, 2002, 13, Environment Agency of England and Wales, 2000, 145, Metcalf & Eddy, 1991]

4.5.3.1.7 Rotating biological contactors (RBC) (T16)

Description

An RBC consists of a series of closely spaced circular discs of polystyrene or polyvinyl chloride. The discs are submerged in waste water and rotated slowly through it.

In operation, biological growths become attached to the surface discs and eventually form a slime layer over the entire wetted surface area of the discs. The rotation of the discs puts the biomass into contact with the organic material in the waste water and then with the atmosphere for the adsorption of oxygen alternately. The rotation is also the mechanism for removing excess solids from the discs so they can be carried from the unit to a sedimentation tank.

Achieved environmental benefits

Reduced BOD, phosphorus, nitrogen and SS levels.

Cross-media effects

Potential odour nuisance.

Operational data

Properly designed, RBCs are quite reliable because of the large amount of biological mass present (low operating F/M). This large biomass also permits them to withstand hydraulic and organic surges more effectively. Staging in this plug-flow system eliminates short circuiting and dampens shock loadings. It is reported that blockage of the discs may occur.

Phosphorus removal efficiencies of 8 – 12 % have been reported using RBCs.

Applicability

Widely applicable in the FDM sector, e.g. to reduce BOD, phosphorus, nitrogen and SS levels.

Example plants

Used in the fish and vegetable oils and fats sectors.

Reference literature

[145, Metcalf & Eddy, 1991]

4.5.3.1.8 Biological aerated flooded filters (BAFF) and submerged biological aerated filters (SBAF) (T17)

Description

Biological aerated flooded filters (BAFF) and submerged biological aerated filters (SBAF) are hybrid suspended/attached growth systems, which are best described as activated sludge plants which contain high voidage media to encourage bacterial growth. Generally, they also allow a certain amount of physical filtration within the same structure.

Achieved environmental benefits

Reduced BOD/COD levels.

Operational data

Backwashing takes place approximately every 24 hours to remove surplus biomass. Consequently, secondary sedimentation is not required. To treat the backwashing water, a sedimentation or flotation facility is required.

Applicability

Primary use is as a polishing stage in domestic waste water treatment, however SBAF is being used increasingly in the FDM sector.

Economics

BAFF reactors are reported to be a cost effective treatment of soluble organic matter.

Example plants

Used in the meat, fruit and vegetable, soft and alcoholic drinks and dairy sectors.

Reference literature

[13, Environment Agency of England and Wales, 2000]

4.5.3.1.9 High rate and ultrahigh rate aerobic filters (T18)

Description

High rate and ultrahigh rate aerobic filters give the potential for higher than usual loading rates to aerobic systems. The process employs a high waste water recycle rate, directed through an integral nozzle assembly. Air is introduced through the nozzle, providing a high shear force on the bacteria and an intense degree of turbulence/oxygenation. It is this high shear force undergone by the bacteria which makes this process so different from other aerobic techniques, i.e. micro-organisms are passed through the nozzle resulting in the existence of only very small bacteria in the system, which differs from other systems where bacteria are not subjected to such shear and where higher life forms also exist.

Achieved environmental benefits

Reduced BOD/COD levels.

Cross-media effects

These filters do not give a quality of waste water suitable for river discharge.

Operational data

Ultrahigh rate aerobic systems offer the potential for loading aerobic systems up to 50 - 100 times greater than conventional aerobic treatment. Nevertheless, since they do not give a quality of waste water suitable for river discharge, a second aerobic stage, which is more conservatively loaded, is required.

Applicability

Widely applicable in the FDM sector.

Economics

Reduced capital investment.

Driving force for implementation

Reduced plant size and capital investment.

Example plants

Used in the fish sector.

4.5.3.2 Anaerobic processes

In the absence of oxygen, organic matter is broken down, producing methane (CH₄) as a by-product, which is used to heat the reactors. In standard anaerobic processes, the reactors are usually unheated, but in high rate anaerobic processes, the reactors are usually heated. In both cases, the temperature of the reactor has to be maintained at around 30 – 35 °C (mesophylic) or 45 – 50 °C (thermophylic), and whether heat is required depends essentially on the temperature of the feed [145, Metcalf & Eddy, 1991, 200, CIAA, 2003].

Although anaerobic growth is slower than in an aerobic process, higher BOD loadings are achievable with an anaerobic technique (in terms of kg BOD/m³ of reactor volume) for high strength waste water. Anaerobic techniques are generally utilised in those industries where there is a high level of soluble and readily biodegradable organic material and the strength of the waste water, expressed in COD, is generally greater than 1500 – 2000 mg/l. For the FDM sector, the application of anaerobic waste water treatment is largely confined to relatively heavily polluted waste water with a COD between 3000 and 40000 mg/l, e.g. in the sugar, starch, fruit and vegetable and alcoholic drinks sectors. There has recently been some success in using certain anaerobic systems even for less heavily polluted waste water with a COD between 1500 and 3000 mg/l, e.g. in breweries, dairies and in the fruit juice, mineral water and the soft drinks sectors [65, Germany, 2002]. Where there are large fluctuations in volume and strength, e.g. for waste water in the fruit and vegetable sector, this treatment is less effective.

One of the most fundamental aspects of anaerobic waste water treatment is that the vast majority of organic carbon associated with the influent BOD is converted to methane as opposed to being used for new cell growth. The opposite is true with aerobic processes, which convert most of the organic carbon to new cells which eventually form waste biosolids that require either further treatment or off-site disposal. Anaerobic processes produce much less waste sludge. Also the methane produced has a high calorific value and as such can be re-used as fuel, e.g. elsewhere in an installation.

An anaerobic system alone would not achieve a final waste water quality high enough for discharge to a watercourse. Therefore anaerobic installations are usually followed by an aerobic system (see Section 4.5.3.1), as the latter achieves lower absolute release levels, and will remove hydrogen sulphide ensuring that the final waste water is well aerated to assist in the breakdown of the remaining BOD. The energy gained from the anaerobic plant can be equivalent to that consumed by the aerobic plant. In certain circumstances the aerobic treatment may be the MWWTP. This will depend upon the receiving WWTP and the balance between waste water treatment charges and an on-site aerobic treatment stage. The anaerobically treated waste water may be surface aerated on-site prior to transfer to a MWWTP. This is normally carried out in a post treatment holding tank providing positive dissolved oxygen levels before being discharged to a WWTP.

The methanogenic bacteria involved in the final stage of the anaerobic process, producing the methane gas, need to be protected from excessive chlorinated and sulphur compounds, pH and temperature fluctuations. In the acidification stage other bacteria will predominate and break down many of the substances which cause the problems. Due to the slow microbial growth there is no phosphorus removal. No nitrification and denitrification occurs so nitrogen cannot be removed by anaerobic treatment.

Modern reactor designs permit higher loading rates, increase biogas production or offer greater stability. Once the bacterial populations in such systems are adapted to the waste water then increased stability occurs.

On-site treatment facilities relying upon an anaerobic reactor as the main treatment process have a similar layout. They have a waste water collection sump/vessel or equalisation tank from which the waste is pumped/flows to a primary treatment tank. The primary treatment processes are as described for aerobic systems.

From the primary treatment stage, the waste water is passed to a conditioning or buffer tank where the waste water is “conditioned”, e.g. pH correction or nutrient addition, before it is passed via the influent distribution system through to the bio-reactor. Early anaerobic reactors allow the initial stages of the anaerobic metabolism to be initiated in the conditioning tank (often referred to as the acidification tank). Modern reactor designs allow all the metabolic pathways to take place in the reactor. The conditioning tank is, therefore, generally only required for pH correction and nutrient addition.

Treatment occurs in the reactor, producing biogas which must be collected. Other components often included are a sludge storage tank, vent gas disposal and primary treatment facilities.

Typical performance data of some anaerobic techniques are shown in Table 4.58.

Process	Input COD (mg/l)	Hydraulic retention time (h)	Organic loading (kg COD/m ³ per day)	COD removal (%)
Anaerobic lagoons			0.6 – 1	
Anaerobic contact process	1500 – 5000	2 – 14	0.5 – 5.3	75 – 90
Fixed-bed	10000 – 70000	24 – 48	1 – 15	75 – 85
UASB	5000 – 15000	4 – 12	2 – 12 (- 60)	75 – 85
Expanded bed reactor	5000 – 10000	5 – 10	5 – 30	80 – 85
Fluidised bed reactor			40 – 60	
Internal circulation (IC) reactor			31	

Table 4.58: Typical process and performance data of anaerobic waste water treatment processes [145, Metcalf & Eddy, 1991, 159, CIAA-CEFS, 2003]

Some common operational problems experienced with anaerobic treatment processes are given in Table 4.59.

Problem	Possible solution
Lack of macro-nutrients	BOD:N:P ratios are normally maintained at 500:5:1
pH	The pH is maintained at 6.8 – 7.5
Temperature	The optimum temperature for mesophilic bacteria is 35 – 37 °C
Lack of micro-nutrients	Minimum quantities of micro-nutrients are maintained, especially for Fe, Ca, Mg and Zn, according to the specific process employed
Physical blockage of the reactor inlet pipework	Effective screening and primary treatment is essential
Overloading	Care needs to be taken to ensure the original hydraulic, solid and organic loading design rates do not exceed the manufacturer’s recommendations

Table 4.59: Common operational problems experienced with biological treatment processes [13, Environment Agency of England and Wales, 2000]

4.5.3.2.1 Anaerobic lagoons (T19)

Anaerobic lagoons are similar to aerobic lagoons (see Section 4.5.3.1.4), with the difference that the anaerobic lagoons are not mixed [145, Metcalf & Eddy, 1991]. They may give rise to odour problems, due to H₂S emissions [208, CIAA-AAC-UFE, 2003].

In the soft and alcoholic drinks sector, it has been reported that anaerobic lagoons are more than 2 m deep.

4.5.3.2.2 Anaerobic contact processes (T20)

Description

The anaerobic contact process can be likened to the aerobic activated sludge process, as separation and recirculation of the biomass is incorporated into the design. Untreated waste water is mixed with recycled sludge solids and then digested in a reactor sealed off from the entry of air.

Achieved environmental benefits

Reduced BOD/COD levels.

Operational data

Compared with the high performance processes of UASB (see Section 4.5.3.2.4) and expanded and fluidised bed reactors (see Section 4.5.3.2.7), contact stabilisation processes do not produce such high biomass concentrations in the reactor and are, therefore, run at comparatively lower space loadings (usually up to 5 kg COD/m³ per day). Their main advantage, however, lies in their relatively trouble-free operation and, in particular, their lack of clogging problems.

Since the anaerobic sludge produces gas outside the reactor and the gas volume continues to rise, there is frequently a need for a degasification unit between the methane reactor and the separator unit. The degasification may be achieved by means of vacuum degassing, stripping, cooling or slowly rotating agitators. This feature allows the process to be operated at 6 – 14 h retention times.

Applicability

Applicable in FDM installations with waste water containing high strength soluble wastes.

Driving force for implementation

This technique provides a relatively trouble-free operation and lack of clogging problems.

Example plants

Used in the meat and sugar sectors.

Reference literature

[13, Environment Agency of England and Wales, 2000, 145, Metcalf & Eddy, 1991]

4.5.3.2.3 Anaerobic filters (T21)

Description

In the anaerobic filter, the growth of anaerobic bacteria is established on a packaging material. The packaging retains the biomass within the reactor and it also assists in the separation of the gas from the liquid phase. The system can be operated in the upflow or downflow mode.

Achieved environmental benefits

Reduced BOD/COD levels and waste stabilisation.

Operational data

Because the bacteria are retained on the media and do not wash off in the waste water, mean cell residence times in the order of 100 days can be obtained.

Applicability

Suitable for treating heavily polluted waste waters having COD of 10000 – 70000 mg/l.

Reference literature

[1, CIAA, 2002, 13, Environment Agency of England and Wales, 2000, 65, Germany, 2002, 145, Metcalf & Eddy, 1991]

4.5.3.2.4 Upflow anaerobic sludge blanket (UASB) (T22)Description

In the UASB system, the waste water is directed to the bottom of the reactor for uniform distribution. The waste water passes through a blanket of naturally formed bacterial granules with good settling characteristics so that they are not easily washed out of the system. The bacteria carry out the reactions and then natural convection raises a mixture of gas, treated waste water and sludge granules to the top of the reactor. Patented three-phase separator arrangements are used to separate the final waste water from the solids (biomass) and the biogas.

Achieved environmental benefits

Reduced BOD/COD levels.

Operational data

Loadings of up to 60 kg COD/m³ per day have been reported, but a more typical loading rate is 10 kg COD/m³ per day with a hydraulic retention time of 4 hours.

Table 4.60 shows the reported performance of a UASB reactor in the brewing sector.

Initial load (kg COD/m³ per day)	5 – 10
Final COD level (mg/ml)	500 – 1000
Sludge generated per kg of COD removed (SS/kg)	0.04 – 0.08
Further treatment is necessary to discharge waste water with these concentrations to receiving waters	

Table 4.60: Reported performance of a UASB reactor in the brewing sector

One disadvantage of the UASB reactor is the technique's sensitivity to FOG. Fat levels have to be below 50 mg/l in the waste water, otherwise they have a detrimental effect on the process. On the other hand, a particular advantage of the process is the formation of pellets. This permits not only rapid reactivation after month-long breaks in operation, but also the sale of surplus sludge pellets, e.g. for the inoculation of new systems.

Applicability

This process is particularly suitable for waste water with a low solid content and with relatively low COD levels (<2000 mg/l) and when small surface area is available. Sludge-bed reactors are currently the most widespread used reactors in the FDM sector.

Example plants

Used in the meat, fruit and vegetable, brewing, starch and sugar sectors.

Reference literature

[13, Environment Agency of England and Wales, 2000, 136, CBMC - The Brewers of Europe, 2002, 208, CIAA-AAC-UFE, 2003]

4.5.3.2.5 Internal circulation (IC) reactors (T23)

Description

There is a special configuration of the UASB process (see Section 4.5.3.2.4), i.e. the IC reactor, in which two UASB reactor compartments can be put on top of each other, one high loaded and one low loaded. The biogas collected in the first stage drives a gas-lift resulting in an internal recirculation of the waste water and sludge, hence the process name.

Achieved environmental benefits

Reduced BOD/COD levels.

Operational data

One of the main advantages of the IC reactor is that it can undergo a certain amount of self-regulation, irrespective of the variations in incoming flows and loads. As the load increases, the quantity of methane generated also increases, and further increases the degree of recirculation and hence dilution of the incoming load. Typical loading rates for this process are in the range: 15 – 35 kg COD/m³ per day.

Applicability

Widely applicable in the FDM sector.

Reference literature

[13, Environment Agency of England and Wales, 2000]

4.5.3.2.6 Hybrid USAB reactors (T24)

Description

The hybrid process is a variation of the conventional UASB (see Section 4.5.3.2.4). This incorporates a packed media zone above the main open zone. This allows for the collection and retaining of non-granulated bacteria which, in conventional UASB reactors, would be lost from the process. The lower sludge zone acts in exactly the same way as within a conventional UASB reactor and is responsible for the majority of the biodegradation of the organic material. The role of the micro-organisms and media in the packed zone is to provide a certain amount of polishing treatment, to hold biological solids in reserve, and to prevent the biomass from washing out of the reactor.

Achieved environmental benefits

Reduced BOD/COD levels.

Operational data

Anaerobic hybrids are high rate systems with typical loading rates in the region of 10 - 25 kg COD/m³ per day.

Applicability

Widely applicable in the FDM sector.

Reference literature

[13, Environment Agency of England and Wales, 2000]

4.5.3.2.7 Fluidised and expanded bed reactors (T25)

Description

These reactors are similar to the anaerobic filters (see Section 4.5.3.2.3). If the particles and biomass are completely mixed, the process is known as a **fluidised bed**, whereas a partially mixed system is known as an **expanded bed**.

Achieved environmental benefits

Reduced BOD/COD levels and waste stabilisation.

Operational data

To achieve high volume-time yields of 15 – 35 kg COD/m³ per day, it is absolutely essential to fill the methane reactors with as constant a volume of adequately acidified solids-free waste water as possible. For this reason, all large scale systems have been built as two-stage systems, i.e. with a separate acidification stage.

In the **fluidised bed** reactor the carrier material is constantly in motion, with a bed expansion of 50 % or more. The carrier material (usually sand but sometimes pumice or plastic pellets) is kept in suspension by means of high recirculation rates. The recirculation must be strong enough to keep the carrier material in suspension, but care must be taken to ensure that excessive circulation does not cause the biomass to become detached from the carrier material.

The **expanded bed** reactor also incorporates support media, often no more than sand or synthetic plastic materials. Light materials are often used to minimise the up-flow velocities required to fluidise the beds, particle sizes are typically in the range 0.3 – 1.0 mm.

Applicability

Applicable to FDM installations with waste water of low pollution loads with an average COD of between 1500 and 3600 mg/l.

Example plants

Used in the sugar sector.

Reference literature

[13, Environment Agency of England and Wales, 2000, 65, Germany, 2002]

4.5.3.2.8 Expanded granular sludge bed reactors (EGSB) (T26)Description

EGSB reactors use granular sludge of the type found in UASB reactors (see Section 4.5.3.2.4) but they operate with a much greater depth of granular sludge and a higher water rise rate. The digester uses recirculated treated water and is fitted with a three-phase (solid, liquid, gas) separator.

Achieved environmental benefits

Reduced BOD/COD and nitrogen levels. Reduced electrical energy requirements due to power generation by burning the methane produced in the CHP unit, e.g. in a molasses distillery.

Operational data

Loading rates up to 30 kg COD/m³ per day have been reported. The water rise rate is typically of 3 m/h, compared to 1 m/h for a UASB. The initial commissioning/acclimatisation phase is not long for EGSB reactors.

Table 4.61 shows the reported performance of an EGSB reactor in the brewing sector.

Initial load (kg COD/m³ per day)	15 – 25
Final COD level (mg/ml)	500 – 1000
Sludge generated per kg of COD removed (SS/kg)	0.04 – 0.08
Further treatment is necessary to discharge waste water with these concentrations to receiving waters	

Table 4.61: Reported performance of an EGSB reactor in the brewing sector

In an example molasses distillery, an EGSB reactor treats the condensed vapours from the condensation unit and the singlings from distillation/rectification. The reactor reduces the COD and nitrogen load in the downstream activated sludge unit. The methane gas produced is burned in a CHP plant, to generate electricity and heat. The high efficiency of the reactor, results in the production of only small quantities of surplus aerobic sludge. In this example, it is concentrated in a decanter and used for agricultural purposes or disposed of to a MWWTP.

Applicability

Widely applicable in the FDM sector.

Driving force for implementation

Reduction in waste water treatment costs and reliable compliance with discharge limits.

Example plants

Used in the sugar, soft and alcoholic drinks and brewing sectors.

Reference literature

[65, Germany, 2002, 136, CBMC - The Brewers of Europe, 2002]

4.5.3.3 Aerobic/anaerobic combined processes

4.5.3.3.1 Membrane bio-reactors (MBR) (T27)

Description

An MBR is a variation on conventional activated sludge whereby a number of membrane modules, or cartridges, are placed within the body of the reactor vessel. Following biological treatment, the mixed liquor is pumped under static head pressure to the membrane unit where the solids and liquids are separated, the clean waste water is discharged, and the concentrated mixed liquor is pumped back to the bio-reactor. The MBR can be operated in either **aerobic or anaerobic** mode, thereby increasing the range of suitable chemicals, e.g. used for membrane cleaning in biological treatment.

Achieved environmental benefits

Reduced BOD/COD levels.

Cross-media effects

Higher energy consumption than conventional activated sludge and additional waste water produced when the fouling of the membranes occurs.

Operational data

An MBR operates across a range of loading rates, but can achieve a higher treatment rate in a number of ways, i.e. increased static pressure increases the amount of dissolved oxygen thereby aiding mass transfer; using oxygen instead of air and using multistage system to optimise the process. For oil and grease applications, concentrations in the waste water may be reduced to less than 15 mg/l.

An MBR provides highly efficient biomass separation, allowing the biomass concentration within the upstream reactor to be up to ten times greater than the concentration normally attainable in a conventional suspended growth system. When using an MBR, no secondary sedimentation is required and very broad MLSS levels can be achieved, i.e. 12 – 17000 mg/l. Figure 4.39 shows a simplified process flow diagram of an MBR.

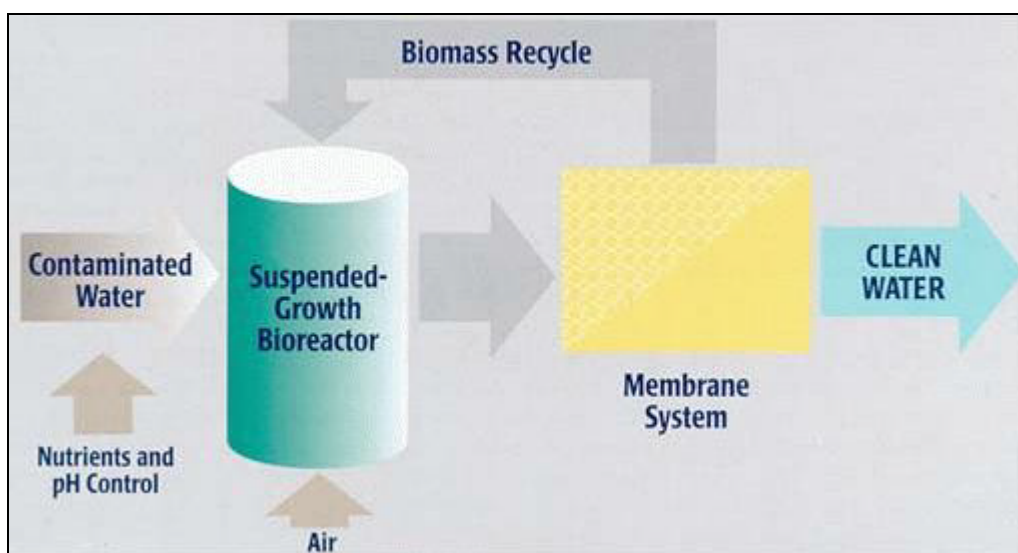

Figure 4.39: MBR system simplified process flow diagram
[155, UBC Civil Engineering, 2003]

The energy consumption, for pumping, might be significantly higher than conventional activated sludge but it can be minimised by applying gravity feed of the waste water. An example dairy in Ireland treats 9000 m³/d of waste water to high standards for discharge to a local watercourse, applying gravity feed to make the process low energy intensive.

Fouling of the membranes may be a major problem. Aeration and backwashing are used to try and control this problem, which may result in additional waste water being produced. DAF (see Section 4.5.2.6) is used to scour and clean the membrane surfaces to prevent biofouling.

Applicability

MBR is applicable in all FDM installations. This technique has the advantage of having low space requirements. This system is ideal for higher strength, lower volume waste water. It is especially attractive in situations where a long solids retention time is required to achieve the necessary biological degradation of the pollutants. Furthermore, waste water containing not readily degradable compounds, e.g. phenols, pesticides, herbicides and chlorinated solvents, and high organic pollution can be treated with MBR.

Economics

High operating costs.

Example plants

Used in the meat, fruit and vegetable, dairy and soft and alcoholic drinks sectors. It is reported to be under development in the starch sector.

Reference literature

[13, Environment Agency of England and Wales, 2000, 155, UBC Civil Engineering, 2003, 250, UK TWG, 2004]

4.5.3.3.2 Multistage systems (T28)

Description

The various **aerobic** and **anaerobic** waste water treatment processes can be applied alone or in combination. When they are applied in combination arranged in series, the technique is called **multistage systems**. Waste water treatment takes place successively in individual stages, which are kept separate from each other by means of separate sludge circuits.

Achieved environmental benefits

Reduced BOD/COD levels and water re-use.

Operational data

The following process combinations are generally used during aerobic treatment:

- activated sludge/activated sludge
- trickling filter/trickling filter
- trickling filter/activated sludge
- activated sludge/trickling filter
- lagoons/activated sludge
- lagoons/trickling filter.

In the meat, fruit and vegetable and soft and alcoholic drinks sectors, a two-stage biological system, anaerobic followed by aerobic, can be used to achieve a quality of waste water suitable for re-use or discharge to a watercourse.

Applicability

Applicable in FDM installations with high strength waste water.

Example plants

Used in the meat, fruit and vegetable, soft and alcoholic drinks, vegetable oils and fats and starch sectors.

4.5.4 Tertiary treatments

After secondary treatment, further treatment may be needed either to enable the water to be re-used as process water or low grade wash-water, or to meet discharge requirements. Tertiary treatment refers to any process that is considered a “polishing” step, up to and including disinfection and sterilisation systems.

In this document, tertiary treatment means an advanced treatment of the waste water to remove constituents of particular concern including ammonia, plant nutrients, dangerous and priority hazardous substances or residual SS and organics.

Plant nutrients, i.e. nitrogen and phosphorus, need to be removed before discharge into surface waters in sensitive areas [209, EC, 1991]. In selecting an appropriate nutrient control strategy, it is important to assess:

- the characteristics of untreated waste water
- the type of WWTP to be used
- the level of nutrient control required
- the need for seasonal or year-round nutrient removal.

4.5.4.1 Biological nitrification/denitrification (T29)

Description

This technique is a variant of the activated sludge process. In this section, four types of processes are described.

In **preceding denitrification**, the incoming waste water first enters the denitrification basin. $\text{NH}_4\text{-N}$ passes through the basin unchanged, whereas organic N is partially hydrolysed to $\text{NH}_4\text{-N}$. In the subsequent nitrification basin, the hydrolysis is completed and the ammonium in particular is nitrified. The nitrate formed is transported via the return sludge and also via intensive recirculation from the nitrification basin outlet to the denitrification basin, where it is reduced to nitrogen.

In a system with **simultaneous denitrification**, aerobic and anoxic zones are created on a targeted basis by controlling the input of oxygen into the basin. Simultaneous denitrification systems are mostly designed as circulation basins or carousel basins.

In **intermittent denitrification**, fully stirred activated sludge basins are periodically aerated. In the activated sludge basin, aerobic and anoxic processes take place successively in the same basin. The extent of nitrification and denitrification can largely be adjusted to the feed conditions by varying the operating times.

In **cascaded denitrification**, several basin compartments consisting of anoxic and aerobic zones (preceding denitrification) are arranged in series without intermediate sedimentation. The untreated water is fed into the first cascade to ensure optimum utilisation of the substrate present in the waste water. The return sludge flow is fed into the first basin. Here, there is no need for internal recirculation within the individual stages.

Achieved environmental benefits

Nitrogen levels are reduced and energy is saved.

Operational data

This technique has a high potential for removal efficiency, a high process stability and reliability, relatively easy process control and space requirements.

In the starch sector, it is reported that nitrification and denitrification reactions occur in an anoxic medium which can be obtained either by a sequenced aeration of the activated sludge tank or in a separated anoxic zone. The removal of nitrogen is carried out using preceding denitrification.

Applicability

Applicable in FDM installations with waste water containing nitrogen.

Economics

Moderate cost.

Example plants

Used in the fruit and vegetable and starch sectors.

Reference literature

[31, VITO, et al., 2001, 65, Germany, 2002, 145, Metcalf & Eddy, 1991]

4.5.4.2 Ammonia stripping (T30)

Description

In addition to biological processes, a number of physico-chemical processes are available for the purification of nitrogen loaded waste water streams. In the FDM sector, condensate, which contains high concentrations of ammonium, can be stripped of ammonia in a two-step system. The system consists of a desorption and an absorption column, which are both filled with packaging material to increase the water-air interface.

The **desorption column** is charged with an alkalised condensate from the top, to shift the $\text{NH}_4^+ - \text{NH}_3$ equilibrium in the direction of NH_3 , which subsequently drops downwards in the column. At the same time, air is injected at the base of the column. In the countercurrent process, a transfer of ammonia, therefore, takes place from the aqueous phase into the gaseous phase.

Subsequently, the air enriched with ammonia is transferred into the **adsorption column**, where the removal of the ammonia from the stripping air is effected by an acidic solution, approximately 40 % ammonium sulphate, being circulated in the desorption column. The air now cleansed of ammonia is finally re-used for stripping.

The condensate, which has a low ammonium content after stripping, is partially re-used as service water and the remaining condensate surplus is channelled into the aerobic biological purification process. The technique is summarised in Figure 4.40.

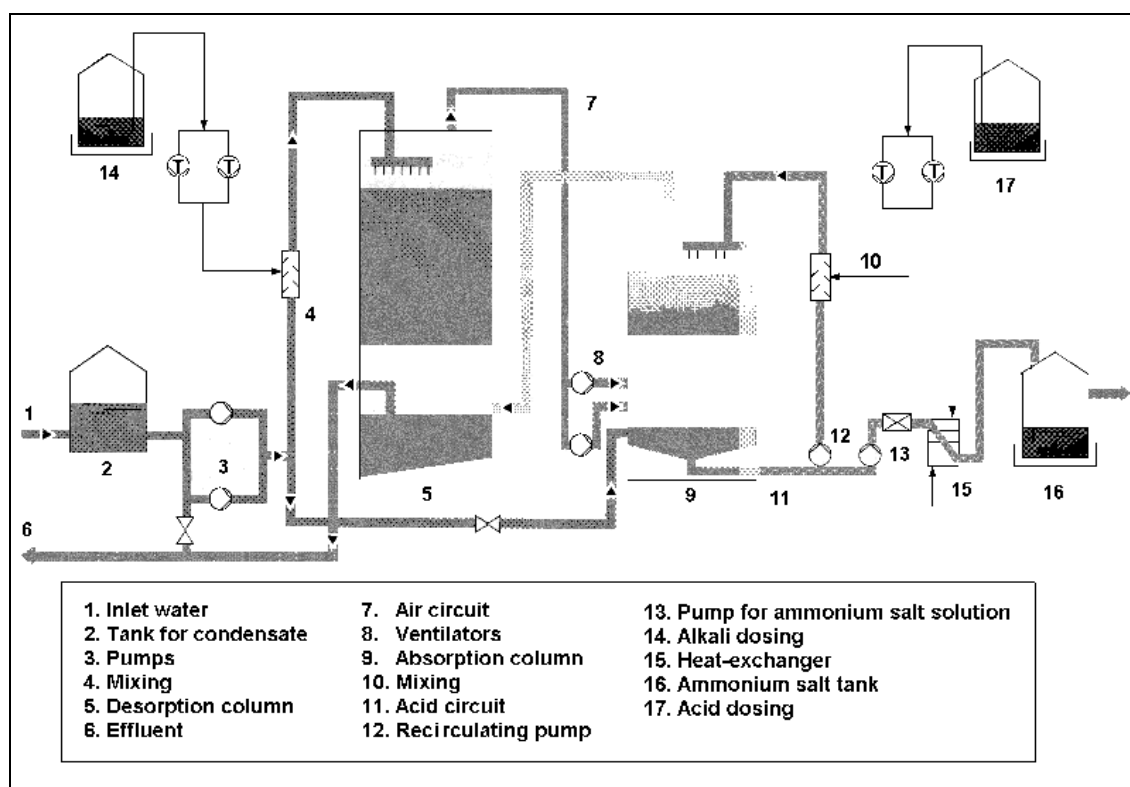

Figure 4.40: The ammonia stripping process

Achieved environmental benefits

Reduced nitrogen levels. Less waste created, i.e. the ammonium sulphate $(\text{NH}_4)_2\text{SO}_4$ solution created during this process can be utilised as a liquid fertiliser or non-protein source of nitrogen for the feeding of ruminants. Water re-use as service water, i.e. re-use of condensate, which has a low ammonium content.

Operational data

Ammonium concentrations of <2 mg/l can be achieved in the outflow. This corresponds to an efficiency degree of approximately 99 %.

Example design parameters for ammonia stripping from condensate generated in the sugar sector are shown in Table 4.62.

Parameter	Units	Value
Water throughput	m ³ /h	400
Ammonia concentration in the condensate	mg/l	150
Ammonium concentration in the outflow (at 55 °C)	mg/l	1.7
Air consumption	Nm ³ /h	320000
Energy consumption	kW	300

Table 4.62: Design parameters for ammonia stripping of sugar industrial waste water (condensate)

Applicability

Technically, the process of ammonia stripping has proven itself for waste water streams with high ammonia concentrations.

Economics

The low ammonium content condensate and the ammonium sulphate solution can both be re-used.

Driving force for implementation

Ammonia concentration in waste water is normally regulated because of its toxic effect on the ecosystem of the receiving water.

Reference literature

[65, Germany, 2002]

4.5.4.3 Phosphorus removal by biological methods (T31)Description

FDM waste water may contain significant amounts of phosphorus if the cleaning agents used have phosphate ingredients. 10 – 25 % of the phosphorus entering the system can be removed during primary or secondary treatment. If further removal is needed, biological treatment methods can also be used. These methods are based on stressing the micro-organisms in the sludge so that they will take up more phosphorus than is required for normal cell growth. Two types of biological treatment processes used for phosphorus removal are described in this section.

The proprietary **A/O process** for mainstream phosphorus removal is used for combined carbon oxidation and phosphorus removal from waste water. This process is a single-sludge suspended growth system that combines anaerobic and aerobic sections in sequence.

In the proprietary **phostrip process** for side-stream phosphorus removal, a portion of the return activated sludge process is diverted to an anaerobic phosphorus stripping tank.

Achieved environmental benefits

Reduced phosphorus and BOD/COD levels.

Operational data

Phosphorus removal efficiencies of various waste water treatment methods are summarised in Table 4.63.

Treatment operation or process	Removal of phosphorus entering the system (%)
Primary treatment	10 – 20
Precipitation (see Section 4.5.2.9)	70 – 90
Activated sludge (see Section 4.5.3.1.1)	10 – 25
Trickling filter (see Section 4.5.3.1.5)	8 – 12
RBC (see Section 4.5.3.1.7)	8 – 12
Biological phosphorus removal	70 – 90
Carbon adsorption (see Section 4.5.4.4)	10 – 30
Filtration (see Section 4.5.4.5)	20 – 50
RO (see Section 4.5.4.6)	90 – 100

Table 4.63: Phosphorus removal efficiencies of various waste water treatment methods

Biological treatment is reported to be more difficult to handle than precipitation.

Applicability

Applicable in FDM installations with waste water containing phosphorus.

Example plants

Used in the fruit and vegetable sector.

Reference literature

[31, VITO, et al., 2001, 145, Metcalf & Eddy, 1991]

4.5.4.4 Dangerous and priority hazardous substances removal (T32)

Description

Organic solvents, pesticide residues, and toxic organic and inorganic chemicals may appear in waste water. Directive 76/464/EEC [206, EC, 1976] on pollution caused by certain **dangerous substances** discharged into the aquatic environment and its daughter directives, established the List I ‘particularly dangerous’ and List II ‘less dangerous’ groups of substances on the basis of the chemicals’ toxicity, persistence and bioaccumulation. Directive 2000/60/EC [207, EC, 2000] on water policy aims to achieve the elimination of **priority hazardous substances**. This Directive states that pollution through the discharge, emission or loss of priority hazardous substances must cease or be phased out. The European Parliament and the Council, on a proposal from the Commission, agreed on the substances to be considered for action as a priority and on specific measures that need to be taken against pollution of water by those substances.

The removal of many of these substances can be implemented through the appropriate use of some treatments, such as sedimentation (see Section 4.5.2.5), precipitation (see Section 4.5.2.9), filtration (see Section 4.5.4.5) and membrane filtration (see Section 4.5.4.6). Further removal can be implemented using tertiary treatments such as carbon adsorption and chemical oxidation.

Carbon adsorption is an advanced waste water treatment method. Granular-medium filters are commonly used upstream of the activated carbon contactors to remove the soluble organics associated with the SS present in secondary effluent. Both granular and powdered carbons are used and appear to have a low affinity for low molecular weight polar organic species. Granular activated carbon works by adsorbance of the contaminants onto and within the carbon granules. These types of filtration media are also used to remove some chemicals, tastes and odours.

Chemical oxidation can be used to remove ammonia, to reduce the concentration of residual organics, and to reduce the bacterial and viral content of waste waters. The oxidants used include chlorine, chlorine dioxide and ozone.

Achieved environmental benefits

Reduced levels of dangerous and priority hazardous substances, BOD/COD and phosphorus. Disinfection of waste water, if chemical oxidation is used.

Cross-media effects

Waste production.

Operational data

When using **carbon adsorption**, high influent SS concentrations will form deposits on the carbon granules resulting in pressure loss, flow channelling or blockages and loss of adsorption capacity. Lack of consistency in pH, temperature and flowrate may also affect the performance of carbon contactors.

Phosphorus removal efficiencies of 10 – 30 % have been reported using carbon adsorption.

Applicability

Applicable for all FDM installations with waste water containing dangerous and priority hazardous substances.

Economics

High energy costs.

Driving force for implementation

Legislation compliance.

Example plants

Carbon adsorption is used in the meat, fruit and vegetable and soft and alcoholic drinks sectors.

Reference literature

[31, VITO, et al., 2001, 145, Metcalf & Eddy, 1991, 206, EC, 1976, 207, EC, 2000]

4.5.4.5 Filtration (T33)

Description

Filtration, e.g. slow filtration, fast filtration, deep-bed filtration, surface filtration (microscreening), biofiltration and coagulation filtration, can be used as a waste water polishing step to remove solids. Unlike sedimentation (see Section 4.5.2.5) or DAF (see Section 4.5.2.6), filtration does not require any difference in density between the particles and liquid. The separation of particles and liquid is brought about by a pressure difference between the two sides of the filter allowing the passage of water through the filter. Thus, the particles are held back by the filter medium.

Filters may be either gravity filters or pressure filters. Depending on the nature of the solids, a **standard sand** or **dual media** filter (sand/anthracite) can be used. There are now a number of constantly self cleaning sand filters available which have proven to be extremely effective at polishing suspended solids from the final waste water.

Achieved environmental benefits

Reduced levels of SS and phosphorus.

Operational data

In the brewing sector, the use of sand filters to achieve waste water requirements more stringent than 15 mg/l of BOD and 20 – 30 mg/l of SS has been reported. Sand filters are used to remove SS, as the soluble BOD is very low after extended aerobic treatment.

Phosphorus removal efficiencies of 20 – 50 % have been reported using filtration.

Applicability

Applicable in all FDM installations to achieve low SS emission levels.

Example plants

Used in the meat, fruit and vegetable, brewing, drinks and vegetable oils and fats sectors.

Reference literature

[1, CIAA, 2002, 13, Environment Agency of England and Wales, 2000, 65, Germany, 2002, 136, CBMC - The Brewers of Europe, 2002]

4.5.4.6 Membrane filtration (T34)

Description

Membrane filtration processes use a pressure driven, semi-permeable membrane to achieve selective separations. Much of the selectivity is established by designations relative to pore size. The pore size of the membrane is relatively large if precipitates or suspended materials are being removed or very small for the removal of inorganic salts or organic molecules. During operation, the feed solution flows across the surface of the membrane, clean water permeates through the membrane, and the contaminants and a portion of the feed remain in the solution. The clean or treated waste water is referred to as “the permeate or product water stream”, while the stream containing the contaminants is called “the concentrate, brine or reject”.

Cross-flow microfiltration (CFM) is cross-flow filtration using membranes with pore sizes in the range of 0.1 – 1.0 μ . The feed stream does not require extensive primary treatment, while the membrane is relatively resistant to fouling and can be easily cleaned.

Ultrafiltration (UF) is similar to CFM, but the UF membranes have smaller pores, 0.001 - 0.02 μ . The smallest pore size UF membrane has the capacity to reject molecules with diameters greater than 1 nm or nominal molecular weights greater than 2000. Some primary treatment may be necessary to prevent membrane fouling. For most UF designs, the introduction of adsorbents or flocculants to the feed stream is not recommended since they may plug the membrane module.

Reverse osmosis filtration (RO) has the ability to reject dissolved organic and inorganic molecules. Water is separated from dissolved salts by filtering through a semi-permeable membrane at a pressure greater than the osmotic pressure caused by the salts. The advantage of RO is that dissolved organics are less selectively separated than in other processes. The purified solution permeates through the membrane.

Nanofiltration (NF) is a relatively new technique combining features of UF and RO with a high selectivity. Its name is derived from its approximate cut-off size of some nanometres or more exactly molar masses of 200 – 1000 g/mol. This is achieved with special nanofiltration membranes which still have pores of a defined size, but their retention depends on the electrostatic charge of the molecules to be separated. The membranes have selective permeability for minerals, i.e. high permeability for monovalent cations and anions and lower permeability for bivalent cations. Nanofiltration systems are operated at medium pressures in the range of 1 – 5 MPa.

Electrodialysis enables ionic separation by using an electrical field as a driving force as opposed to a hydraulic force. The membranes used are adapted to make them ion-selective (for cations and anions). A number of cells are required to make up the complete electrodialysis unit. Chemical precipitation of salts on the membrane surface and clogging by the residual organic colloids can be prevented by pretreating the waste water with activated carbon, or chemical precipitation or by some sort of multimedia filtration.

Achieved environmental benefits

Suspended, colloidal and dissolved solids levels are reduced. Phosphorus levels are also reduced, i.e. using RO. Concentration of waste water streams to reduce volumes prior to further treatment/disposal, e.g. possible concentration of dilute waste to concentrations suitable for re-use. Possible recovery of expensive ingredients for re-use or return/sales to suppliers on-site or elsewhere. Recovery of ingredients/materials at source. Recovery of water for re-use.

Cross-media effects

Additional waste water may be produced.

Operational data

Problems may arise from the fouling of membranes and gel polarisation. Since the flux rates through membranes are relatively low, an extensive membrane area is required to recover material.

Using UF, up to 90 – 95 % of the feed can be recovered as product water. Phosphorus removal efficiencies of 90 – 100 % have been reported using RO.

RO membranes are very susceptible to fouling and may require an extensive degree of primary treatment. Oxidants which may attack the membrane and particulates, e.g. oil, grease and other materials which may cause a film or scale to form, must be removed by primary treatment or the membrane will need to be subjected to frequent cleaning cycles. RO product streams are normally of very high quality and suitable for re-use in the manufacturing process. Standard practice is to dispose of the reject stream or to apply a suitable treatment to the concentrated brine. The recovery that can be obtained, as well as the operating pressure required, will depend on the type of dissolved solids and their concentrations.

Applicability

The CMF technique is applicable for removing bacteria and contaminants from feed streams, but not for effective pesticide treatment unless the active ingredients are relatively insoluble or attached to the suspended material. CMF is used in the UK to remove heavy metals from industrial waste waters.

Applications of UF include the removal of oil from waste water and the removal of turbidity from colour colloids. In the fish sector, the use of UF to treat waste water from minced fish production has been reported, however, this method is reported not to be cost effective for separating proteins from fish-meal waste water.

RO has been used to remove heavy metals and pesticides whose active ingredient molecular weights are greater than 200.

Economics

The operating cost associated with the use and cleaning of membranes can be very high. There are also high energy costs.

Example plants

Used in the meat, fish, fruit and vegetable, soft and alcoholic drinks and vegetable oils and fats sectors.

Reference literature

[13, Environment Agency of England and Wales, 2000, 87, Ullmann, 2001, 134, AWARENET, 2002, 145, Metcalf & Eddy, 1991]

4.5.4.7 Biological nitrifying filters (T35)

Ammonia is usually removed during secondary biological treatment by allowing for extended sludge time periods to facilitate the proliferation of nitrifying bacteria. Nevertheless, it is also common to install separate tertiary biological nitrifying filters. These are usually variations on the standard percolating or high rate aerobic filters. They may be followed by activated sludge plants or attached growth systems.

4.5.4.8 Disinfection and sterilisation (T36)

The disinfection and sterilisation techniques all operate on the same basic principle. They affect the cell structure within bacteria and prevent their replication. Disinfectants used for FDM production are within the scope of Directive 98/8/EC [226, EC, 1998]. Assessment of the environmental and human health effects of active substances in disinfectants will start in 2007. Several types of treatment can be applied. This involves the use of oxidising biocides, non-oxidising biocides and UV radiation. Steam is also used for disinfection, to kill thermo-resistant micro-organisms.

4.5.4.8.1 Biocides

Description

Oxidising biocides work by oxidising the bacterial cell walls in order to prevent replication. This relies on the use of strong oxidising agents such as chlorine/bromine, ozone and hydrogen peroxide. The use of chlorine compounds, e.g. chlorine gas, chlorine dioxide, sodium or calcium hypochlorite, relies upon the formation of hypochlorous acid (the active biocide) in aqueous solution. Bromine based biocides are becoming more prevalent in industrial applications due to the hypobromous acid species dissociating at a higher pH than the equivalent chlorine based compounds.

Ozone can be generated from air or pure oxygen when a high voltage is applied across the gap of narrowly spaced electrodes. Ozone dissipates rapidly after generation, so no chemical residual persists in the treated waste water but its dissolved oxygen content is high. No halogenated compounds are produced. Ozone is also used as an oxidising agent.

Non-oxidising biocides operate by chemically altering the cell structure in order to prevent bacterial cell replication. They are being used increasingly in the FDM sector; some examples are quaternary ammonium salts, formaldehyde and glutaraldehyde.

Achieved environmental benefits

Waste water re-use, even as drinking water.

Cross-media effects

When using chlorine compounds, organic compounds present in the waste water may react with chlorine to form toxic substances, e.g. chloramines and other organic halogen compounds. Furthermore, this reaction can reduce the effective chlorine dose rate. Chlorine can also be very aggressive towards construction materials, even stainless steel. The organic halogen compounds can impair subsequent biological waste water treatment, after waster re-use. When using ozone, carcinogenic or mutanogenic compounds may be formed and ozone is a respiratory irritant, so occupational exposure needs to be controlled.

Operational data

Ozonation is carried out in deep and covered contact chambers. It is effective without the need for further chemicals. Ozone will naturally decay back to oxygen after a few hours.

In the fish sector, ozone has been used to treat a variety of waste water streams and is reported to be most effective in treating more dilute types of wastes. For more concentrated waste water, e.g. from squid processing operations, ozone can be applied as a polishing step.

Applicability

Applicable in all FDM installations.

Economics

The use of ozone has a moderately high cost. The use of other biocides has relatively low capital and operating costs.

Example plants

Used in the meat, fish, fruit and vegetable and soft and alcoholic drinks sectors.

Reference literature

[1, CIAA, 2002, 13, Environment Agency of England and Wales, 2000, 17, Envirowise (UK) and March Consulting Group (UK), 1998, 66, EC, 1998, 134, AWARENET, 2002]

4.5.4.8.2 UV radiation

Description

UV radiation is perhaps the most significant advancement in disinfection technology over the past 10 years. UV light at 254 nm is readily absorbed by the cellular genetic material within bacteria and viruses, and prevents the cell from replicating. The dose rate is measured in milliwatts per square centimetre multiplied by the contact time in seconds. The actual dose depends on the transmittance, i.e. related to the presence of other compounds which can absorb and reduce UV light effectiveness, of the waste water stream.

Achieved environmental benefits

Waste water re-use, even as drinking water.

Cross-media effects

Treated waters with UV radiation are liable to reinfection, so they need to be used quickly and hygienically.

Operational data

The main advantages of UV disinfection over the other techniques include, no storage and no need for the use of dangerous chemicals and the absence of harmful by-products. On the other hand, the main disadvantage of UV disinfection is that a direct line of sight must be maintained between the lamp and the bacteria/virus. Any appreciable levels of suspended solids or turbidity (which decrease the transmittivity) will shield the bacteria and prevent their disinfection. Waste water containing compounds with high transmittance values require higher doses of UV radiation. Ozone and UV radiation are both unstable and must be generated as used.

Applicability

Applicable in all FDM installations.

Economics

Relatively low capital and operating costs.

Example plants

Used in the meat, fish, fruit and vegetable, dairy and soft and alcoholic drinks sectors.

Reference literature

[1, CIAA, 2002, 13, Environment Agency of England and Wales, 2000, 66, EC, 1998, 134, AWARENET, 2002]

4.5.5 Natural treatments

In the natural environment, biological and physico-chemical processes occur when water, soil, plants, micro-organisms and the atmosphere interact. Natural treatment systems are designed to take advantage of these processes, to provide waste water treatment. The processes involved include many of those used in conventional waste water treatment systems, such as sedimentation, filtration, precipitation and chemical oxidation, but occur at “natural” rates [145, Metcalf & Eddy, 1991]. They are slower than conventional systems. The soil-based systems mainly use the complex purification mechanism of the soil and uptake by crops and other vegetation. In the aquatic-based systems, e.g. natural and constructed wetlands and aquatic plant systems, the vegetation provides a surface for bacterial growth.

Natural treatments are prohibited by law in some MSs, due to concerns about hazards to groundwater [182, Germany, 2003].

4.5.5.1 Integrated constructed wetlands (ICW) (T37)Description

ICW are distinguished from other constructed wetland techniques on the basis that they are designed to facilitate the widest possible range of ecological conditions, as found in natural wetlands including those of soil, water, plant and animal ecology. In addition, the ICW concept strives to achieve “landscape fit” and ‘habitat restoration/creation’ into its designs. Emphasis is placed on monitoring water quality within the wetlands and the surrounding land and watercourses. Strategically located monitoring wells are also monitored regularly.

The ICW design simultaneously applies primary, secondary and subsequent levels of treatment in its “free surface water flow”. This is achieved by the construction of a series of shallow interconnected basins or lagoons planted with a wide variety of aquatic plant species. The waste water is introduced at the highest point in these lagoons and is gravity fed through the lagoons. These sequentially arranged lagoons are self contained individual ecosystems. With each step, a cleaner level of waste water is attained. The relationship of the volume of waste water to the area of wetland in the overall ICW design determines the outflowing water quality.

The macrophytic vegetation used in the ICW design performs a variety of functions. Its primary function is the support of biofilms (slime layers), which carry out the principal cleansing functions of the wetland. It also facilitates the sorption of nutrients and acts as a filter medium, and through the use of appropriate emergent vegetation, can control odours and pathogens. While the vegetation has the capacity to filter suspended solids it also increases the hydraulic resistance, thus increasing the residence time.

Achieved environmental benefits

SS, BOD/COD, nitrogen and phosphorus levels are reduced. Energy is saved, compared to conventional treatment. Reduced greenhouse gas emissions. No chemicals are used. No sludge disposal is required. There are nutrient recycling opportunities, e.g. by composting. These provide a habitat for a wide variety of plants and animals. They may be a local amenity and educational resource. The site may be reclaimed.

Cross-media effects

The groundwater that flows beneath the wetlands has lower nutrient levels than surrounding terrestrial sites. Phosphorus is retained in the soil.

Operational data

An example cheese plant in Ireland produces 85 tonnes of cheese per day from 800000 litres of milk and generates up to 1300 m³ of waste water. The plant has an ICW comprising 8 hectares of lagoons occupying 20 hectares which treat 1.1 million litres of waste water per day. The waste water is pumped to the wetland about half a mile from the dairy and fed in at the highest point. The system of lagoons progresses downwards along the contours of the land and the treatment is achieved progressively as the waste water passes through the system.

Performance levels from this ICW are shown in Table 4.64.

Sample point	COD mg/l	Total P mg/l	Ammonia mg/l	Nitrate mg/l
Influent waste water	3167	212	12	102
Final monitoring pond	36.5	0.5	0.05	<1

Table 4.64: Performance levels reported for an ICW

Applicability

The ICW technique can be applied in a wide range of circumstances, e.g. high or low concentrations of contaminants and hydraulic loading rates that may vary over time. ICWs may be built as an entirely new entity or may form part of an existing wetland, aquatic landscape feature or WWTP. The land requirement associated with ICWs can restrict its application, e.g. land requirements can range from 10 m² to many hectares depending on the volume of the waste water produced and its pollution characteristics.

Economics

It has been reported that, compared to a conventional plant, the ICW approach allows a saving on operational, depreciation and capital costs of EUR 0.03, EUR 0.49 and EUR 0.46/kg of COD, respectively. The reduction is mainly due to the reduced energy costs, lack of chemical usage, lack of sludge production and storage.

The example cheese plant referred to above has reported that its ICW system cost EUR 120000, which is reported to be comparable to EUR 3.175 million for a conventional plant.

Driving force for implementation

Economic savings in the example plant.

Example plants

Several farms, a cheese plant (dairy sector) and a village MWWTP, all in Ireland.

Reference literature

[204, Ireland, 2003]

4.5.6 Sludge treatment

This section covers the treatment of waste water sludge. Techniques for the use and disposal of waste water sludges are not covered in this document. The choice of sludge treatment may be influenced by the use and disposal options available to the operator. These include, e.g. landspreading (see Section 4.1.6), disposal by landfill, use as a sealing material, incineration, co-incineration, wet oxidation, pyrolysis, gasification, vitrification.

The capital and operating costs associated with sludge treatment can be high compared with the rest of the WWTP activities and consequently merit consideration, to minimise costs, at an early stage in designing an installation. Environmental legislation is increasingly limiting the disposal options available or significantly increasing their cost.

4.5.6.1 Waste water sludge treatment techniques

Sludge treatment techniques generally either reduce the volume for disposal, or to change its nature for disposal or re-use. Typically, volume reduction through dewatering can occur on-site, whereas further sludge treatment is generally carried out off-site. Reducing the volume of sludge for disposal leads to reduced transport costs and, if going to landfill, reduced landfill charges [13, Environment Agency of England and Wales, 2000]. The treatment techniques normally applied in the FDM sector are detailed below.

4.5.6.1.1 Sludge conditioning (T38)

Description

The purpose of conditioning is to improve the characteristics of the sludge so that it is easier to thicken and/or dewater. The techniques generally used are chemical or thermal. Chemical conditioning assists in the separation of the bound and entrained water from within the sludge. Thermal conditioning involves heating the sludge under pressure for short periods of time.

Achieved environmental benefits

Sludge volume reduction.

Economics

Chemicals costs are generally quite high.

Reference literature

[145, Metcalf & Eddy, 1991]

4.5.6.1.2 Sludge stabilisation (T39)

Description

Sludges are stabilised by chemical, thermal, anaerobic and aerobic processes to improve sludge thickening and/or dewatering and reduce odour and pathogens.

Achieved environmental benefits

Reduction of malodorous constituents. Reduction of the quantity of biodegradable sludge solids. Reduction of the quantity of biodegradable soluble matter, by converting mineralised nitrogen/organic matter into humic rich material. Reduction of pathogens. Reduction of potential for putrefaction.

Cross-media effects

Thermal stabilisation has high energy requirements and may release odours. Aerobic stabilisation also has high energy requirements for stirring and the supply of oxygen.

Operational data

A chemical stabilisation process has low technical requirements and can improve downstream dewatering and reduce odours and pathogens. Nevertheless, it increases the solids content of the sludge.

A thermal stabilisation process has low space requirements and is an effective treatment for dewatering sludge and destroying bacteria. Its selection can depend on whether the heat is natural, recovered as a by-product of the processes operating in the installation or whether direct energy consumption is required.

An aerobic stabilisation process produces odourless sludge and has a relatively easy operation. Nevertheless, the process is significantly affected by temperature and the sludge has poor mechanical dewatering characteristics.

An anaerobic stabilisation process produces gas, which is a source of energy. This technique has long residence time and achieves a good mineralisation of the sludge.

Applicability

Applicable in all FDM installations that produce sludge.

Economics

Thermal and anaerobic stabilisation have high capital costs. Aerobic stabilisation has low capital costs.

Reference literature

[1, CIAA, 2002, 13, Environment Agency of England and Wales, 2000, 65, Germany, 2002, 145, Metcalf & Eddy, 1991]

4.5.6.1.3 Sludge thickening (T40)

Description

Thickening is a procedure used to increase the solids content of sludge by removing a portion of the liquid fraction. The techniques generally used for sludge thickening are sedimentation, centrifugation and DAF. The simplest thickening technique is to allow the sludge to consolidate in sludge sedimentation tanks.

Sludge thickening can be applicable to both primary treatment sludge and secondary treatment sludge. Primary treatment sludge consists mainly of inorganic material and/or primary organic solids. They are generally able to settle and compact without chemical supplementation, as associated water is not excessively “entrained” within the sludge. The water in secondary treatment sludge is bound within the flocs and is generally more difficult to remove.

Achieved environmental benefits

Sludge volume reduction.

Cross-media effects

Possible release of odour when using DAF. High energy consumption and noise and vibration generation when using centrifugation.

Operational data

Sludges that are taken from the bottom of primary and secondary sedimentation tanks will generally be around 0.5 – 1.0 % dry solids content and up to 4 % dry solids for DAF sludges.

When using DAF, the system is kept aerobic. In this case, blockage has been reported.

The thickening efficiency of the sedimentation process is affected by the height of the sludge layer and not by the volume of the supernatant above it. Therefore, a tall and narrow tank is more effective than a low tank with a large surface area. This technique has a low energy consumption.

Depending upon the pattern of primary sludge removal, consideration can be given to the use of two tanks to allow for quiescent sedimentation in one tank whilst the other is in the fill cycle. If this is not possible, the sludge inlet is arranged to be near the top of the tank, possibly onto a baffle plate, to minimise hydraulic disturbance. Residence time within the tank will depend on the nature of the sludges. Excessive retention must be avoided to minimise the possibility of anaerobic conditions occurring with consequent odour and corrosion problems.

Gentle agitation must be allowed for within the tank. A picket fence thickener within the tank is most commonly used, to help reduce stratification of the sludge and to assist in the release of any entrained gases and water. A conventional gravity/picket fence thickener is capable of thickening the sludge up to 4 – 8 % dry solids, depending on the nature of the raw sludge and in particular on the relative content of primary sludge. Addition rates to the thickener are in the range of 20 – 30 m³ of feed/m² of surface area per day.

Centrifugation provides a good capture of solids that are difficult to filter, has low space requirements and is easy to install, but it achieves a low solids concentration in the cake. It has a high energy consumption and requires skilled maintenance personnel.

For many sites, sludge thickening alone is sufficient to reduce the volume of sludge to a level that enables off-site disposal to be undertaken in a sufficiently cost effective manner. For larger sites, the thickening process is a first stage prior to further dewatering.

Applicability

Applicable to all FDM installations that produce sludge.

Economics

Reduction of pumping costs in large WWTPs. Sedimentation thickening has low operational costs.

Driving force for implementation

Reduction of pipe size and pumping costs on large WWTPs.

Reference literature

[1, CIAA, 2002, 13, Environment Agency of England and Wales, 2000, 65, Germany, 2002, 145, Metcalf & Eddy, 1991]

4.5.6.1.4 Sludge dewatering (T41)

Description

The objective of sludge dewatering is the same as that of thickening (see Section 4.5.6.1.3) with the difference that the solid content is much higher. A number of sludge dewatering processes exist and selection will depend upon the nature and frequency of the solids produced, and the sludge cake required. The dewatering techniques generally used are centrifugation, belt filter press, filter press and vacuum filters.

Achieved environmental benefits

Sludge volume reduction.

Cross-media effects

High energy use, noise and vibration generation when using centrifugation, although this varies depending on the speed and intensity of the individual operation.

Operational data

Centrifuges are continuous processes which produce a cake of up to 40 % dry solids for certain sludges. Because of the “closed” nature of the centrifuge, associated odour problems are minimal. Furthermore, centrifugation provides a good capture of solids that are difficult to filter, has low space requirements and easy installation. Nevertheless, this process needs a high consumption of energy, achieves a low solids concentration in the cake and requires skilled maintenance personnel.

Filter presses are batch processes, and can be manually intensive. The “plates” are covered with a suitable filter cloth, dependent upon the application, and the sludge is fed into the plate cavity. The sludge is dewatered under pressure with the filtrate passing through the filter cloth. Once the pressure is released and the plates separated, the cake is either manually scraped off or vibration mechanisms are employed to automate the process. A filter press can produce up to 40 % dry solids cake and attain a filtrate with low SS. The disadvantages of using this technique are that it is essentially a batch operation and that it has a limited filter cloth life.

The belt press and vacuum filters are continuous processes with the filter cloth continually running through rollers that forcefully dewater the sludge. Performance optimisation requires regular and specialised maintenance.

A belt press can produce up to 35 % dry solids cake. Furthermore, the belt presses have high dewatering efficiency and relatively easy maintenance. Disadvantages of using them include hydraulic limitations, a short life and sensitivity to sludge feed characteristics.

The vacuum filters are complex systems with a maximum differential pressure of 1 bar. The filtrate may have high SS.

Applicability

Applicable to all FDM installations that produce sludge.

Economics

Sludge with over 10 % dry solids becomes difficult and expensive to pump. Dewatering produces a sludge “cake”, which may be between 20 – 50 % dry solids. Disposal costs fall as the water content is reduced. Filter presses have high labour costs. Vacuum filters have high operating and maintenance costs.

Driving force for implementation

Reduction of disposal costs.

Reference literature

[1, CIAA, 2002, 65, Germany, 2002, 199, Finland, 2003]

4.5.6.1.5 Sludge drying (T42)

Description

Sludge drying is a technique that involves reducing the water content by vaporisation of water to the air. The purpose of drying is to remove the moisture from the wet sludge so that it can be used or disposed of efficiently.

Achieved environmental benefits

Sludge volume reduction.

Operational data

The moisture content of the dry sludge can be as low as 10 %. Drying can be achieved by using natural evaporation, where the local weather and climate conditions make this possible; by recovery of heat produced in the installation or by direct energy consumption.

Reference literature

[145, Metcalf & Eddy, 1991]

4.5.7 Waste water treatment in the various sectors

This section provides information on waste water treatment in specific sectors and individual categories within those sectors.

4.5.7.1 Meat and poultry

4.5.7.1.1 Waste water treatment

Meat processing waste water is treated using the following primary treatment techniques:

- screening (see Section 4.5.2.1)
- fat trap (see Section 4.5.2.2)
- flow and load equalisation (see Section 4.5.2.3)
- DAF (see Section 4.5.2.6)
- diversion tank (see Section 4.5.2.7).

Following primary treatment, on-site secondary treatment may be required, either to achieve the required waste water quality or to minimise off-site waste water treatment charges. For waste water streams with a BOD concentration greater than 1000 – 1500 mg/l, anaerobic treatment processes can be used (see Section 4.5.3.2). It may be possible to discharge final waste water from the anaerobic process following surface aeration. For lower strength waste water streams, aerobic treatment is used (see Section 4.5.3.1). A two-stage biological system (see Section 4.5.3.3.2), anaerobic followed by aerobic, can achieve a quality of waste water suitable for discharge to a watercourse.

If the suspended solids consent limit is low, it may be necessary to use tertiary treatment (see Section 4.5.4). For recycling all or part of the final waste water, if the recycled water is to be used in processing areas as drinking water, tertiary treatment, including sterilisation and disinfection, is essential.

Figure 4.41 shows a typical schematic of a process flow diagram of the waste water treatment applicable to meat and poultry processing of waste water.

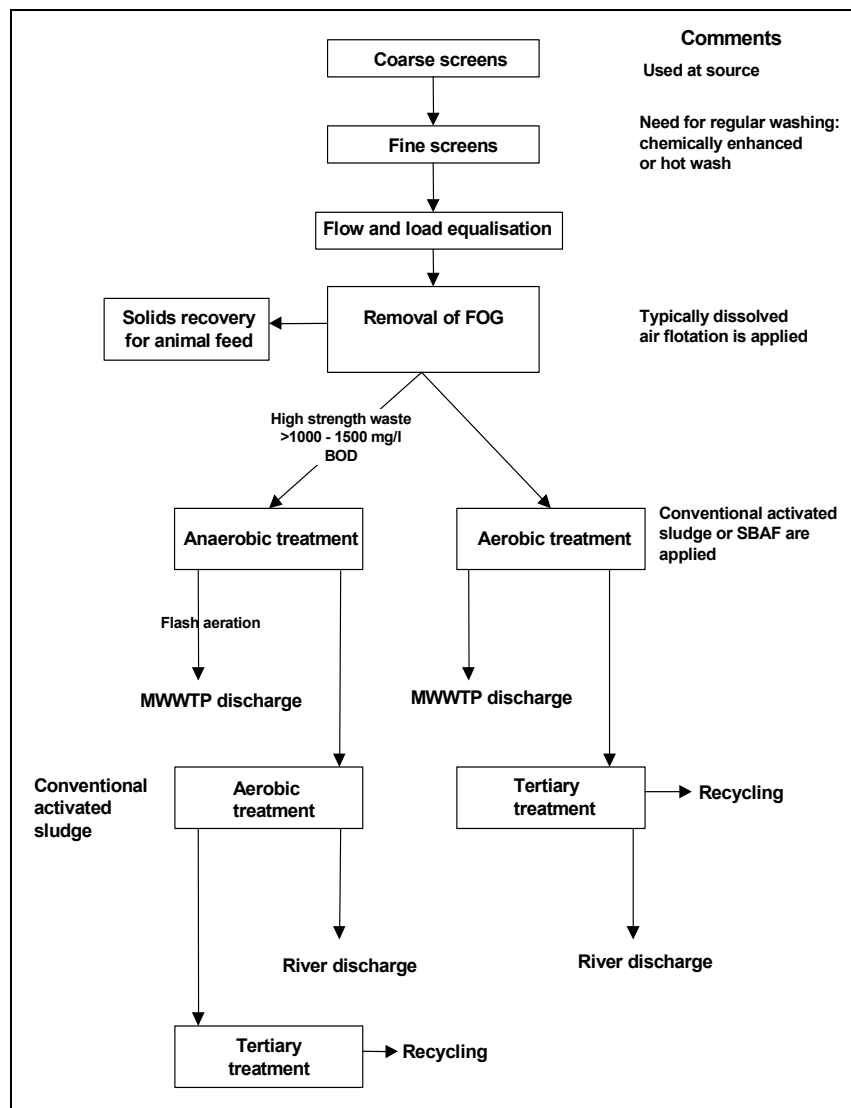

Figure 4.41: Flow sheet of the treatment used for meat and poultry processing of waste water [13, Environment Agency of England and Wales, 2000]

4.5.7.2 Fish and shellfish

4.5.7.2.1 Waste water characteristics

For basic fish processing operations, waste water arises from the handling and storage of raw materials, from fluming fish and offal, from defrosting and from the cleaning of equipment and floor areas. For canning operations, waste water is also generated during the draining of cans and from any spillages of brines, sauces and oils. All of these waste waters need to be treated in a WWTP before they can be discharged. Otherwise, they may cause oxygen depletion and eutrophication problems in the receiving waters.

4.5.7.2.2 Waste water treatment

Fish processing waste water primary treatment applies to the following techniques:

- screening (see Section 4.5.2.1)
- sedimentation (see Section 4.5.2.5)
- DAF (see Section 4.5.2.6)
- centrifugation (see Section 4.5.2.8)
- precipitation (see Section 4.5.2.9).

Table 4.65 shows the characteristics of untreated waste water from the fish sector and its primary treatment efficiencies.

Treatment method	BOD (mg/l)	Total N (mg/l)	Total P (mg/l)	FOG (mg/l)
Untreated	2000 – 28000	400 – 1000	80 – 150	500 – 25000
Centrifugation	1500 – 5000	–	–	500 – 2000
DAF	1500 – 6000	200 – 600	40 – 90	400 – 2000
Precipitation (H ₂ SO ₄) and DAF	800 – 3000	150 – 300	30 – 50	100 – 500
Precipitation (Fe/Mo) and polyelectrolyte	600 – 3000	150 – 300	5 – 10	100 – 500
Two step DAF with precipitation (Fe/Mo) and polyelectrolyte	500 – 1500	100 – 200	5 – 10	50 – 300

Table 4.65: Characteristics of untreated fish industry waste water and primary treatment efficiencies
[134, AWARENET, 2002]

After primary treatment, if the waste water quality is not suitable for discharge to a MWWTP, secondary treatment is needed. Removal efficiency using aerobic treatment (see Sections 4.5.3.1) is high for waste water with BOD/COD <3000 mg/l. For highly polluted waste water, e.g. BOD/COD >3000 mg/l, anaerobic treatment (see Section 4.5.3.2) is used.

Tertiary treatment in the fish sector includes, e.g. membrane separation (see Section 4.5.4.6) and disinfection and sterilisation (see Section 4.5.4.8).

The use of landspreading has been reported in this sector (see Section 4.1.6).

4.5.7.3 Fruit and vegetables

4.5.7.3.1 Waste water characteristics

The processing of fruit and vegetables produces a large volume of waste water, which generally contains high organic loads, e.g. from peeling and blanching; cleaning agents, e.g. disinfectants such as chloride, soil particles, SS such as fibres, dissolved solids, salts, nutrients and plant pathogens. It may also contain pesticide and fungicide residues from the washing of the raw materials. Other parameters to be considered for waste water treatment are pH, temperature, salts. The characteristics of the waste water depend on various factors, such as:

- quality of the influent water and the rate of consumption
- the type of raw materials processed and the type of processing carried out, e.g. peeling, blanching and canning
- the condition of the raw material, e.g. damage, ripeness
- seasonal variations
- type of equipment used
- wet or dry transportation of the products
- cleaning operations and the type of cleaning agents used.

The most important pollutants in the fruit and vegetable sector are BOD and SS. It may be necessary to measure pesticide levels, to comply with local legislation. In the US if levels exceed 0.05 mg/l, corrective action must be taken.

4.5.7.3.2 Waste water treatment

The following treatment options are not necessarily applicable to potato processing. For specific characteristics see Section 4.5.7.3.6.

Before waste water treatment, segregation of water streams is typically applied in the fruit and vegetable sector (see Section 4.7.3.7). After segregation, primary treatment is applied and the following techniques are used:

- screening (see Section 4.5.2.1)
- flow and load equalisation (see Section 4.5.2.3)
- neutralisation (see Section 4.5.2.4)
- sedimentation (see Section 4.5.2.5)
- DAF (see Section 4.5.2.6)
- centrifugation (see Section 4.5.2.8)
- precipitation (see Section 4.5.2.9).

SS and soil are better separated using sedimentation than DAF. However, if the waste water contains appreciable levels of FOG, then a combination of sedimentation and DAF is typically applied.

For the waste water of peeling operations, the use of chemicals may restrict the nutritional exploitation of the separated peel mass. In fact, if peel mass is used for nutrition, separate waste water treatment is needed. Steam peeling plants may have separate units.

In some instances, waste water after primary treatment can be discharged into the MWWTP. For discharges to watercourses, or for treating waste water to a quality suitable for re-use, secondary treatment is required. Due to the seasonal operation, biological treatment of waste water from the fruit and vegetable sector may represent a problem for the operators.

For waste water with a BOD concentration greater than 1000 – 1500 mg/l, anaerobic treatment processes (see Section 4.5.3.2) can be used. After this treatment, waste water may be discharged to a MWWTP following surface aeration, but not to water bodies. For lower strength waste water streams, aerobic treatment (see Section 4.5.3.1) can be used. The waste water from fruit and vegetable processing is often deficient in nitrogen and phosphorus and may require supplements of these nutrients to support adequate biological activity. Nitrification and dephosphatation processes can be stimulated by controlling aeration. A two-stage biological system (see Section 4.5.3.3.2), anaerobic followed by aerobic, may achieve a quality of waste water suitable for discharge to a watercourse.

If stricter permit conditions are in place due to the receiving water, or if the water is to be recycled in the process, then tertiary treatment (see Section 4.5.4) is needed. If the recycled water is to be used in processing areas as drinking water, tertiary treatment, including disinfection and sterilisation, is essential.

Figure 4.42 illustrates a flow sheet of typical waste water treatment techniques used in the fruit and vegetable sector.

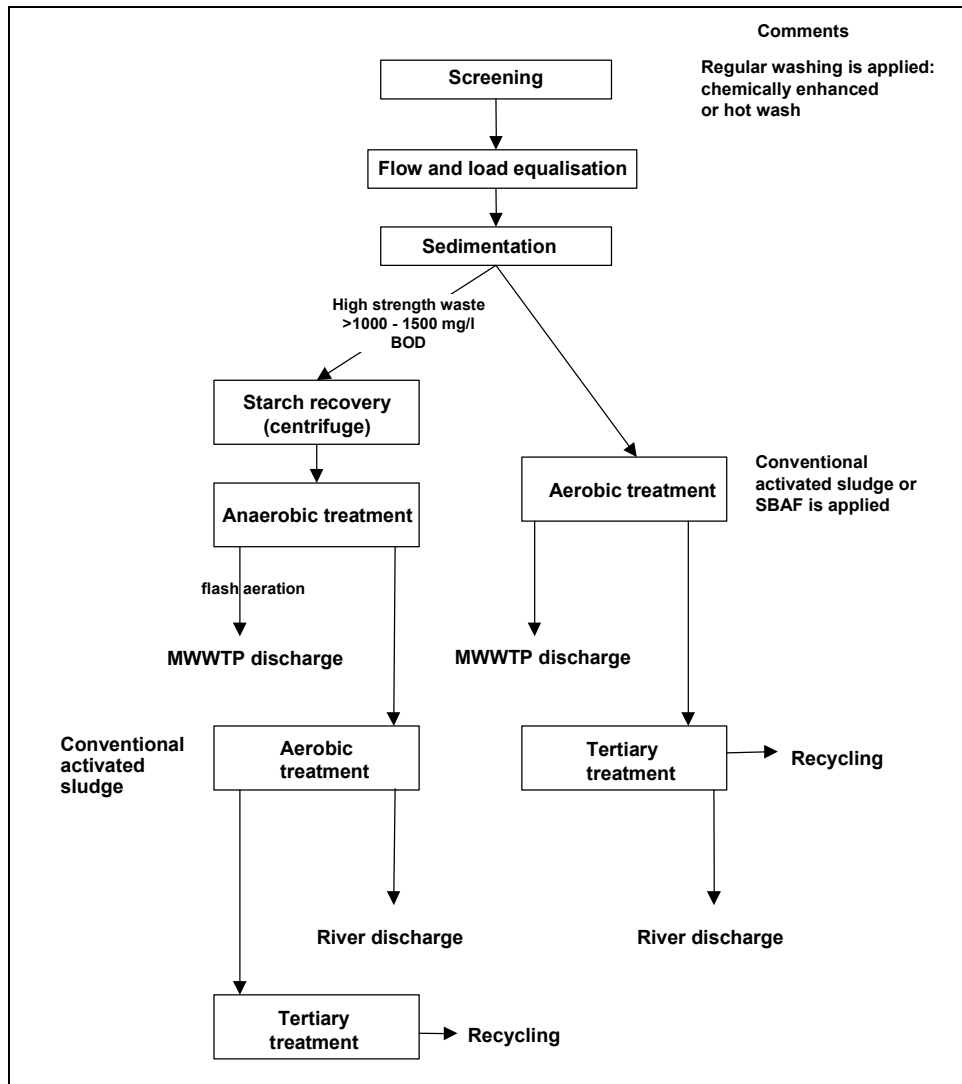

Figure 4.42: Flow sheet of typical waste water treatment in the fruit and vegetable sector [13, Environment Agency of England and Wales, 2000]

Table 4.66 shows some waste water treatment combinations reported for the fruit and vegetable sector.

Combination of techniques
Primary treatments (see Section 4.5.2)
Primary treatments (see Section 4.5.2) + Aerobic processes (see Section 4.5.3.1)
Primary treatments (see Section 4.5.2) + Anaerobic processes (see Section 4.5.3.2) + Aerobic processes (see Section 4.5.3.1)
Primary treatments (see Section 4.5.2) + Anaerobic processes (see Section 4.5.3.2) + Aerobic processes (see Section 4.5.3.1) + Biological nitrification/denitrification (see Section 4.5.4.1) + Phosphorus removal by biological methods (see Section 4.5.4.3)
Primary treatments (see Section 4.5.2) + Anaerobic processes (see Section 4.5.3.2) + Aerobic processes (see Section 4.5.3.1) + Biological nitrification/denitrification (see Section 4.5.4.1) + Phosphorus removal by biological methods (see Section 4.5.4.3) + Precipitation (see Section 4.5.2.9) + Filtration (see Section 4.5.4.5)
Primary treatments (see Section 4.5.2) + Anaerobic processes (see Section 4.5.3.2) + Aerobic processes (see Section 4.5.3.1) + Biological nitrification/denitrification (see Section 4.5.4.1) + Phosphorus removal by biological methods (see Section 4.5.4.3) + Precipitation (see Section 4.5.2.9) + Filtration (see Section 4.5.4.5) + Carbon adsorption (see Section 4.5.4.4)
Primary treatments (see Section 4.5.2) + Anaerobic processes (see Section 4.5.3.2) + Aerobic processes (see Section 4.5.3.1) + Biological nitrification/denitrification (see Section 4.5.4.1) + Phosphorus removal by biological methods (see Section 4.5.4.3) + Precipitation (see Section 4.5.2.9) + Filtration (see Section 4.5.4.5) + Carbon adsorption (see Section 4.5.4.4) + Membrane separation, i.e. CMF (see Section 4.5.4.6)
Primary treatments (see Section 4.5.2) + Anaerobic processes (see Section 4.5.3.2) + Aerobic processes (see Section 4.5.3.1) + Biological nitrification/denitrification (see Section 4.5.4.1) + Phosphorus removal by biological methods (see Section 4.5.4.3) + Precipitation (see Section 4.5.2.9) + Filtration (see Section 4.5.4.5) + Carbon adsorption (see Section 4.5.4.4) + Membrane separation, i.e. RO (see Section 4.5.4.6)

Table 4.66: Some waste water treatment combinations reported for the fruit and vegetable sector [31, VITO, et al., 2001]

4.5.7.3.3 Water recovery in a vegetable processing company – a case study

Description

Because of the water shortage in groundwater resources, and due to a lack of alternative water sources, e.g. no surface water resource was available and the drinking water supply was too expensive, the following water saving techniques were applied in a vegetable processing company:

- re-use of treated waste water for processing operations where drinking water quality was not needed. The aerobic treatment of waste water was supplemented by a polishing step, i.e. sand filtration. As a result, the specific water consumption was reduced to 3 – 3.5 m³/t of product
- reduction of the salt content in the waste water by steam stripping
- increased capacity of the aerobic waste water treatment and the use of anaerobic pretreatment.

Achieved environmental benefits

Reduction in the use of water resources, re-use of waste water and reduction in the water pollution load.

Cross-media effects

High energy demand for the waste water treatment.

Operational data

The installation achieved an increase in its production capacity from 17000 to 55000 t/yr in ten years. The final aim was to replace at least 50 % of the raw water demand, thereby decreasing the specific water consumption below 2 m³/t product.

The waste water treatment of the installation consists of an anaerobic pretreatment (reactor volume of 5000 m³, load of 30 t COD/d and specific load of 6 kg COD/m³/d) followed by an aerobic activated sludge plant. After sedimentation, the waste water is treated in a two step sand filtration process with a maximum capacity of 100 m³/h. After pH correction and/or the addition of flocculants, the water is fed to the UF unit with a capacity of 40 m³/h. The UF unit is operated at low pressure (0.5 – 1 bar) and has hollow fibre membranes. The water is finally treated by a two step RO technique. The retentate of the first step is fed to the second step. The RO equipment has a capacity of 20 m³/h, an operating pressure of 8 – 10 bar and an efficiency of 70 %. Although the water is free of salts and bacteria, the water is still sterilised by UV radiation. Backwash water from the sand filters and the UF unit is recycled to biological treatment.

The typical water quality parameters of the waste water in the different treatment steps and that of fresh groundwater are included in Table 4.67.

Parameter	Unit	Waste water	After biological treatment	After polishing filtration	After sterilisation	Ground water	Process water*
COD	mg O ₂ /l	12000	114		0	0	
pH		8.5	8.3	8.2	5.5	8.3	7
Turbidity	NTU		16	4.3	0		0
Total phosphorus	mg/l		34	34	<0.5	<0.5	<0.5
Conductivity	mS/cm	4.3	4.3	4.2	0.15	2.6	1.4
Ammonia-N (NH ₄ ⁺)	mg/l		<2	<2	<2	0.17	
Iron	mg/l				0.03	0.23	0.1
Hardness	mmol/l		1.0	1.0	<0.3	<0.3	<0.3
Bicarbonate	G/l		2.9	2.9	<0.3	<0.1	<0.2
Total bacteria (CFU)	i/ml				0	0	0
<i>E. coli</i>	i/ml				0	0	0

*1:1 mixture of groundwater and sterilised water

Table 4.67: Water quality parameters of treated waste water, raw water and process water

Economics

The drinking water cost varied between EUR 0.99 – 1.54/m³ and it was expected to increase because of the great demand. The cost of the process water was EUR 1.03/m³.

Driving forces for implementation

The company was using groundwater as it was bacteriologically safe. However, there were some difficulties such as:

- it had to be drawn from a depth of 300 metres
- the local groundwater levels were dropping, leading to shortages
- the groundwater had growing salt concentrations and some parameters were not meeting quality standards. Some parameters compared to WHO guidelines are shown in Table 4.68.

Parameter	Unit	Groundwater	WHO guideline
pH		8.3	6.5 – 8.5
Sulphate	mg/l	126	400
Bicarbonate	mg/l	552	
Chloride	mg/l	550	250
Conductivity	mS/cm	2.6	0.25

Table 4.68: Quality of groundwater source for a vegetable processing installation compared to WHO guidelines

Example plants

A vegetable processing installation in Belgium.

Reference literature

[35, OECD, 2001]

4.5.7.3.4 Re-use of vegetable washing waste water after treatment – a case study

Description

A systems manufacturer has designed, built and commissioned a turnkey WWTP which enables the re-use of up to 55 % of the waste water at a UK vegetable processing installation. The WWTP is based on pretreatment and aerated flow balancing, followed by an advanced MBR, RO and UV disinfection. To effectively separate the biomass, UF is used, fed by a recirculation system from the two bio-reactor tanks. The operation is fully automated with PLC control and data logging of key process parameters, e.g. flows, dissolved oxygen, pH and temperature. An aeration and mixing system is incorporated to achieve the necessary high rates of oxygen mass transfer into the concentrated biomass.

Figure 4.43 shows a diagram of a WWTP at a vegetable processing installation.

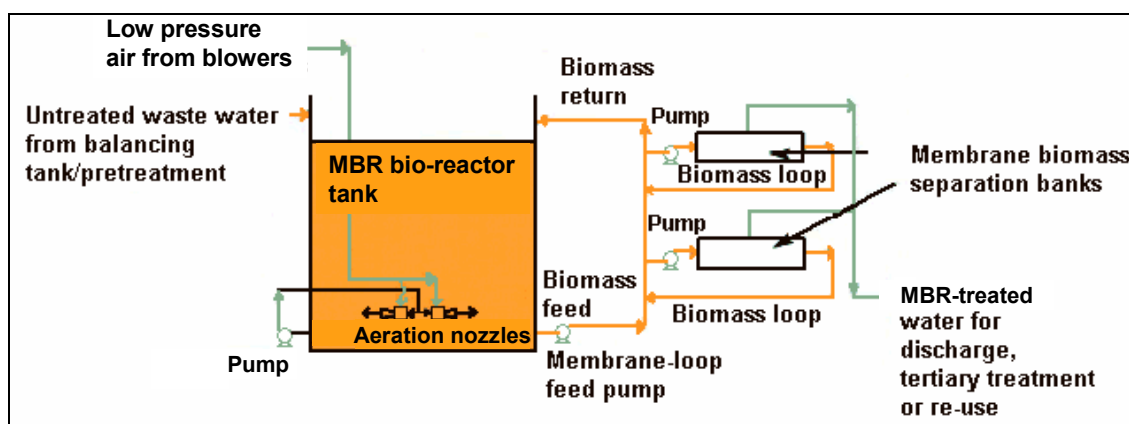

Figure 4.43: WWTP at a vegetable processing installation for water re-use [102, UK, 2002]

Achieved environmental benefits

Reduced water consumption, e.g. water is re-used. Reduced waste water pollution.

Operational data

A total of 1200 m³/day of vegetable washing waste water can be produced by the installation with up to 815 m³/day being pumped forward to the advanced MBR. Following the RO and UV disinfection stages, up to 650 m³/day can be returned back to the factory as salad washing and process water. The influent COD_{total} that is received at the balancing tank is up to 1440 kg/day, depending on the production rate.

The intensive aerobic environment created in the bio-reactors, each with a design MLSS level of 15000 mg/l, combined with the high relative sludge age means that a high quality final waste water can be achieved with a much smaller “footprint”. The bio-reactor volume is reduced as low as 20 % of the size of a conventional treatment.

About half of the waste water after full treatment reaches drinking water quality and can be re-used within the installation. The original COD of about 1500 mg/l was reduced to almost zero. The ultrafiltration biomass separation system also provides a permeate suitable for feeding directly into the RO/UV post treatment stage.

Example plants

A UK vegetable processing installation.

Reference literature

[102, UK, 2002]

4.5.7.3.5 Re-use of water during pea processing, after chlorination

Microbial contamination can be controlled by the use of chlorine dioxide which is effective against biofilm at a concentration approved for drinking water, i.e. 0.5 ppm. Figure 4.44 shows a diagram of a four-stage water re-use scheme at a pea cannery. The chlorination of water used for washing incoming fruit or vegetables, is not allowed in some countries. Re-using of water in processes where the water may be in direct contact with the product is also not always permitted.

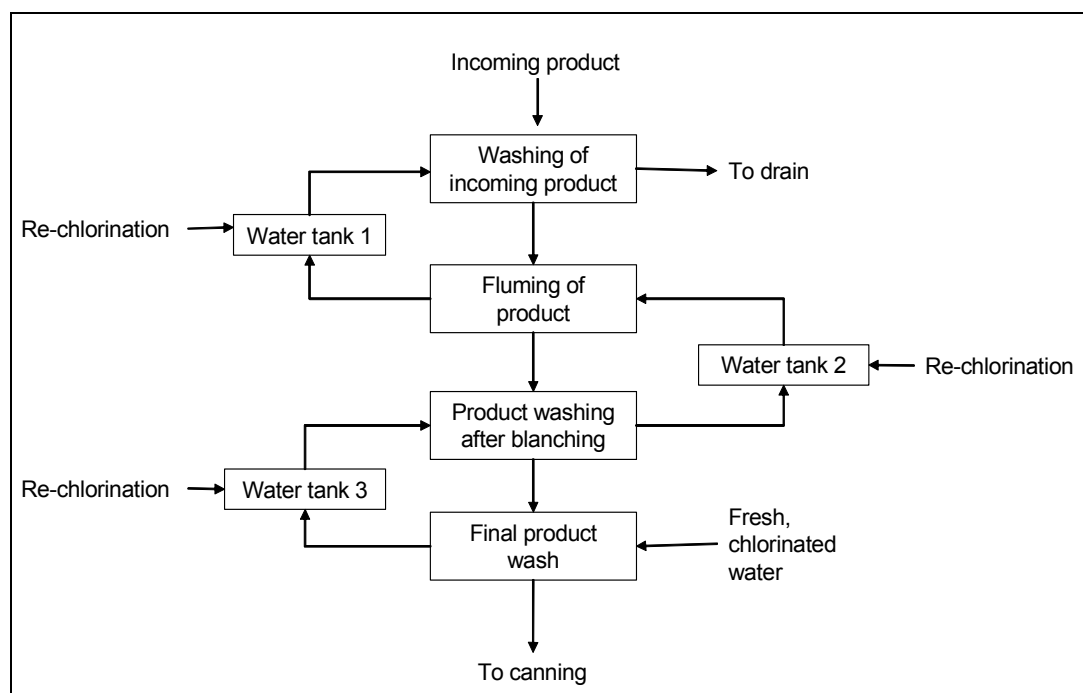

Figure 4.44: Re-use of water in the canning industry
[13, Environment Agency of England and Wales, 2000]

4.5.7.3.6 Potato processing

Although the organic constituents of the waste water from potato processing are readily biodegradable, problems may arise during waste water treatment largely due to the following factors [65, Germany, 2002]:

- pollution loads may fluctuate substantially in the course of the day, week, year
- high concentrations of impurities
- imbalanced composition of waste water, e.g. preponderance of carbohydrates and sometimes imbalanced mineral nutrient supply
- presence of foam-producing substances, e.g. protein
- risk of bulking sludge formation
- the temperature of the waste water sometimes exceeds 35 – 40 °C, which may necessitate the use of evaporation coolers
- the rapid onset of the anaerobic fermentation process may give rise to undesirable odours
- the acids present during the fermentation processes may result in the pH being reduced to between 4 and 4.5. This acidification takes place within about 2 hours.

In anaerobic/aerobic treatment systems, it is necessary to investigate whether, in view of the N_{total} load, it is possible to treat the entire production waste water or only a substream to ensure that the aerobic stage still has enough carbon for nitrogen elimination. If the above considerations are taken into account, it is possible to use biological processes to clean the highly concentrated waste water from potato processing facilities. UASB reactors may not be suitable for potato peeling operations.

4.5.7.4 Vegetable oils and fats

4.5.7.4.1 Waste water treatment

In recent years, there have been extensive investigations into biological treatment of waste water from edible oil production and refining, with the aim of eliminating the previously unavoidable waste water loads. For example, during production of refined oil from rapeseed, about 10 - 12 m³ waste water can be generated per metric tonne of raw material. The waste water contains levels up to 5000 mg/l COD, 4500 mg/l SS and 1200 mg/l FOG [134, AWARENET, 2002]. Phosphorus is present in inorganic and organic form. Tests have been performed at laboratory and pilot plant scale. Treatment strategies developed and as a result have been implemented in two prototype production scale systems. Both examples are tailored to the special operating conditions of the installations and their local situation. Optimisation of the prototypes is still in progress.

Primary treatment used in the vegetable oil sector generally includes:

- flow and load equalisation (see Section 4.5.2.3)
- sedimentation (see Section 4.5.2.5)
- fat trap (see Section 4.5.2.2)
- DAF (see Section 4.5.2.6)
- precipitation (see Section 4.5.2.9), to reduce phosphorus levels.

Further, secondary treatment is applied and aerobic processes are used (see Section 4.5.3.1). In general, the waste water is well suited to biological treatment. Activated sludge (see Section 4.5.3.1.1), trickling filters (see Section 4.5.3.1.5) and rotating biological contactors (see Section 4.5.3.1.7) can be used. Industry specific factors that can influence biological waste water treatment are the presence of low volatile lipophilic substances, sulphate, elevated phosphatide levels and a low pH.

4.5.7.4.2 Olive oil

See also Section 4.7.4.1, for information about in-process reduction of the amount of waste water and its pollutant load.

The olive mill waste water is considered as one of the most polluting waste waters from the FDM sector and causes great problems in the olive tree cultivation areas in Europe. It has a very high COD, i.e. 200000 mg/l, a low pH, i.e. 3 – 5.9, and a high content of solid matter, i.e. TSS 20000 mg/l. In addition, the high polyphenol content of olive oil waste water, up to 80000 mg/l, make bacterial degradation very difficult and give them phytotoxic characteristics.

Usually, small olive mills, very many of which are below the IPPC Directive threshold, use evaporation lagoons (see Section 4.5.3.1.4). Allowing their waste water to evaporate in open lagoons for months leads to stale odours and, in many cases, leakage causes groundwater contamination. The solid residue is then sent for landspreading (see Section 4.1.6). Direct deposition in olive groves can result in groundwater contamination. Connection to a MWWTP is not usually possible, as olive mills are normally in rural areas where MWWTPs either do not exist or are not designed to treat such waste water. Thermal concentration (not described in this document) can also be used to treat olive oil waste water.

Olive oil waste water can also be treated using an anaerobic WWTP, which can reduce COD levels by 65 – 95 %. This has a high investment cost, particularly because olive oil mills have seasonal harvesting, the campaigns are carried out between October and March and only last three months at each location. The seasonal characteristic of these mills does not affect the treatment as an anaerobic digester can be easily restarted after a dormant state, although it takes some time to re-establish treatment conditions.

The high polyphenol content of the waste water inhibits the growth of aerobic bacteria. In addition, the autoxidation of phenolic compounds during contact of olive oil waste water with air leads to the formation of macromolecular polyphenols which are even more difficult to degrade.

A further alternative treatment of waste water from olive mills can involve an effective primary treatment (see Section 4.5.2) to remove solids. Using precipitation (see Section 4.5.2.9), with the selection of an optimal flocculation agent, eliminates a very high percentage of the dissolved and particulate organic matter which will then be removed by filtration (see Section 4.5.4.5). The final step consists of applying membrane separation (see Section 4.5.4.6) to ensure 95 % reduction of the organic load. This is still under investigation but could be a solution for the future.

Table 4.69 shows a comparison of treatment alternatives for olive oil waste water.

Method	Advantages	Disadvantages
Landspreading	Improved fertility because of K, Mg and organic matter content	Groundwater contamination High salinity Legal limitations Negative effects on vegetation if certain levels are surpassed due to polyphenol content
Evaporation lagoon	Low cost No specialised workers required	Large land surfaces needed Putrid odours and insects Groundwater contamination if the insulation of the basin is not correct
Thermal concentration	Faster system	High power consumption and cost Crust formation in the evaporators
Anaerobic processes	Low energy consumption Methane production Stabilised sludge	Expensive installation

Table 4.69: Comparison of treatment alternatives for olive oil waste water [134, AWARENET, 2002]

4.5.7.4.3 Multistage waste water treatment for vegetable oil refining – a case study

Description

This treatment is a combination of treatment techniques implemented in an example edible oil refinery with special conditions. Its application at other installations may be tested first by, e.g. pilot trials.

The technology is used for on-site treatment of the waste water from the refining of crude oils and fats. Waste water from the segregated streams of soap splitting (acid water), storage and cleaning were combined.

The system comprises the following stages:

- segregation (see Section 4.1.7.8)
- fat trap (see Section 4.5.2.2) in segregated streams
- flow and load equalisation (see Section 4.5.2.3)
- DAF (see Sections 4.5.2.6), at low pH and without precipitation for FOG removal
- neutralisation (see Section 4.5.2.4) and coagulation for the removal of emulsified oils/fats
- DAF (see Sections 4.5.2.6), with precipitation for coagulated oils/fats
- activated sludge (see Section 4.5.3.1.1), in cascaded stages to treat plug-flow conditions
- DAF (see Section 4.5.2.6) to remove sludge
- sedimentation (see Section 4.5.2.5) of SS and flow and load equalisation (see Section 4.5.2.3) of the clear water tank.

Achieved environmental benefits

Reduction in waste water COD by more than 95 %. Some phosphorus reduction.

Cross-media effects

Increased use of chemicals such as caustic soda and coagulants for fat elimination. Increased use of energy for physical and biological process steps. Sludge is produced.

Operational data

Table 4.70 shows the waste water characteristics before and after treatment. Phosphorus is reduced by approximately 50 % and only through biological absorption by assimilation in the sludge biomass. Precipitation cannot be applied in the waste waters containing the phosphatides, i.e. those which are organic.

Parameter	Unit	Inlet	Outlet
Waste water volume	m ³ /h	<25	
COD	mg/l	2500	<150
BOD ₅	mg/l		<5
Lipophilic substances	mg/l	**100	–
Phosphorus* (P _{total})	mg/l	<140	<70
Sulphate up to	mg/l	12000	–
*Source of phosphorus: phospholipids as phosphatides and lecithins			
**Measured using the now cancelled method (DIN 38509, H 17)			

Table 4.70: Waste water characteristics before and after treatment

Table 4.71 shows energy consumption data.

Energy source	Consumption
Steam	12.5 kWh/t unrefined oil
	45 MJ/t unrefined oil
	16 kg/t unrefined oil
Electricity	11.5 MJ/t unrefined oil
	3.2 kWh/t unrefined oil

Table 4.71: Energy consumption data

Table 4.72 shows the operating data of a waste water treatment system at an oil and fat processing facility.

Stage 1: Cooling, neutralisation (NaOH), coagulant and urea addition	
DAF at low pH	Area = 25 m ²
DAF at neutral pH	Area = 25 m ²
Stages 2 – 3: Cascaded activated sludge system (aeration + DAF basins)	
Reactor 1 volume 630 m ³	
Reactor 2 volume 1270 m ³	
Residence time approximately 35 h	
DAF surface area	Area = 45 m ²
Stage 4: Clear water tank, clarified waste water storage tank for sedimentation of residual suspended matter, buffer for rinsing purposes, out feed pump station	
Clear water tank volume 279 m ³	
Stage 5: Sludge treatment	
Sludge storage tank with fine-bubble aeration for aerobic stabilisation of the surplus sludge. Sludge storage tank for fatty sludge from chemical/physical primary treatment, with coarse-bubble aeration for aerobic stabilisation of sludge	

Table 4.72: Description of waste water treatment system at an oil and fat processing facility

Applicability

Oil refineries without any requirement for enhanced phosphorus removal. Table 4.73 shows a summary of applicability data.

Restrictions	Low organic loads
	Good primary fat separation
	No preceding precipitation of phospholipids possible
	Simultaneous precipitation with high P concentrations harmful to biocenosis
	Subsequent precipitation to ensure reliable compliance with P levels only possible with substantial overdosing
Operating reliability	Limited owing to substantial unavoidable fluctuations in quality of untreated waste water
	System requires very high operator input

Table 4.73: Summary of applicability data

Economics

There is substantial investment required for the development and construction of the system. There are costs due to increased input of energy; maintenance and repair; operating personnel and increased waste production. In an example installation, the technique was implemented using external financial assistance.

Driving forces for implementation

More stringent official requirements regarding waste water volume and quality. Local receiving water conditions. Timing of decision on availability of other alternatives. Demonstration system assisted by public funds.

Example plants

One vegetable oil refinery in Germany.

Reference literature

[65, Germany, 2002, 182, Germany, 2003, 185, CIAA-FEDIOL, 2004]

4.5.7.5 Dairy products

4.5.7.5.1 Waste water characteristics

Some important characteristics of dairy waste water for the purposes of treatment are [13, Environment Agency of England and Wales, 2000, 65, Germany, 2002]:

- large daily variation in flowrate
- variable pH
- waste water may be nitrogen deficient, unless the raw water has a high nitrate content or nitric acid is used
- waste water may be high in phosphorus if phosphoric acid is used for clean-up. Milk also has a high phosphorus content, e.g. 93 mg P/100 g whole milk
- the treatment of dairy waste water results in lower surplus sludge than domestic waste water treatment, owing to, e.g. the lower content of suspended solids, the lower F/M ratio used and the higher waste water temperatures
- despite utilising preceding equalisation basins, it is still prudent to allow for peak loads when designing the oxygen supply.

4.5.7.5.2 Waste water treatment

In the dairy sector, solids from washing water from vehicle washing units are generally removed at source. This may be carried out by using sand or grit traps, or the rainwater from the sealed surfaces is generally passed into the on-site waste water treatment system. Next, segregation of waste water is generally applied (see Section 4.1.7.8), by high solids content, very high BOD and high salinity. After segregation, primary treatment is required and the following techniques can be used:

- screening (see Section 4.5.2.1)
- flow and load equalisation (see Section 4.5.2.3)
- neutralisation (see Section 4.5.2.4)
- sedimentation (see Section 4.5.2.5)
- DAF (see Section 4.5.2.6)
- centrifugation (see Section 4.5.2.8)
- precipitation (see Section 4.5.2.9).

Following primary treatment, secondary treatment may be required. For waste water with a BOD concentration greater than 1000 – 1500 mg/l, anaerobic treatment processes are used (see Section 4.5.3.2). Anaerobic techniques are widespread across Europe for dairy waste water when BOD is greater than 3000 mg/l. Following surface aeration, the resultant final waste water from the anaerobic process can be discharged directly to a MWWTP. Nevertheless, there may be a risk of phosphorus release in the final waste water if anaerobic processes are used. For lower strength waste water streams, aerobic treatment (see Section 4.5.3.1) is applied.

Figure 4.45 shows a typical waste water treatment flow sheet applied to dairy waste waters.

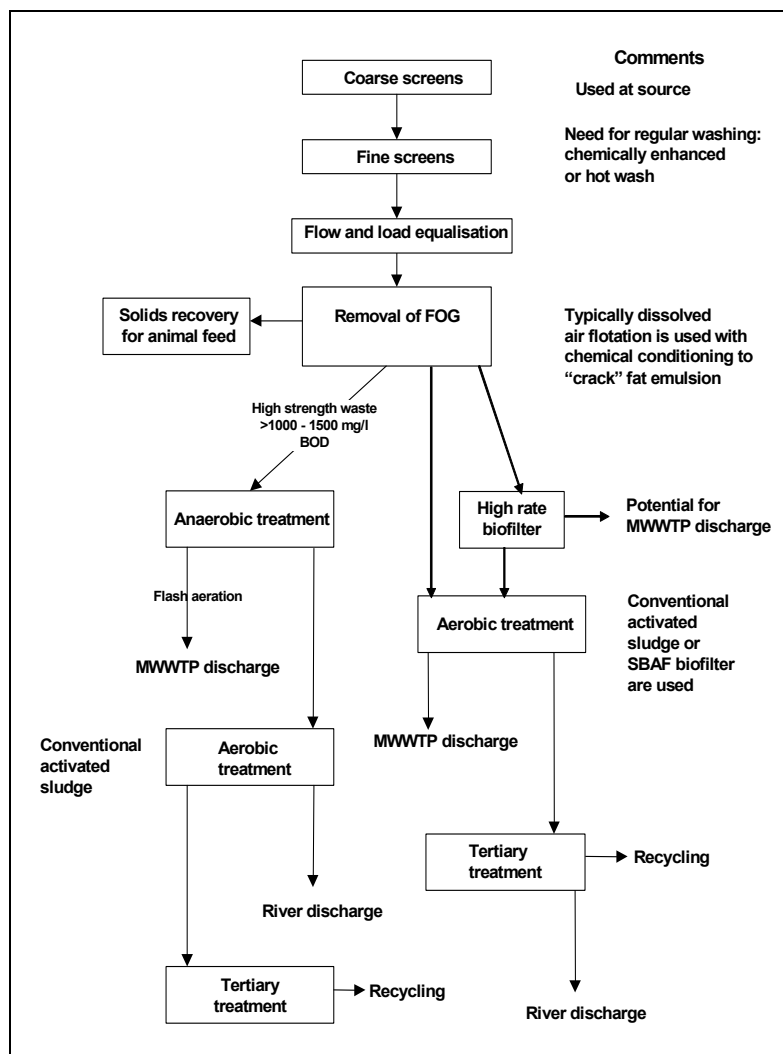

Figure 4.45: Typical waste water treatment applicable to a dairy [13, Environment Agency of England and Wales, 2000]

4.5.7.6 Starch

4.5.7.6.1 Waste water characteristics

Waste water from the starch sector contains high levels of organic matter which is readily biodegradable. COD and BOD levels arise due to the hydrolysis and fermentation of, e.g. reduced sugars, volatile acids and aldehydes. The SS content is not high.

Nitrogen is also present in the waste water. Its production is due to the compounds from the degradation of proteins, e.g. urea and ammonia. The nitrogen content appears to be higher for waste water from potato processing than for grain processing. Metals, e.g. Zn, Ni and Cr, can be found in very limited quantities. When found, they have arisen from the corrosion of metallic vessels and pipes, and from the raw material, e.g. corn, rice and potato.

4.5.7.6.2 Waste water treatment

Starch processing waste water primary treatment applies the following techniques:

- flow and load equalisation (see Section 4.5.2.3)
- sedimentation (see Section 4.5.2.5)
- DAF (see Section 4.5.2.6).

If further treatment is needed, secondary treatment techniques are applied. Anaerobic processes (see Section 4.5.3.2) are used when the load of organic matter is high and when the SS load is low, although reportedly long anaerobic treatments are sometimes used to treat waste waters with high SS levels. A reaction of methanisation occurs and produces biogas which contains 50 – 70 % methane by volume and which is generally recovered in a boiler. The advantage of this treatment is to remove a proportion of the COD load without producing sludge and to save energy. Nevertheless, the optimisation of such a reaction is difficult to obtain and its efficiency can be comprised of between 50 – 80 % in COD load. The choice of having an anaerobic treatment depends also in the loading ratios, e.g. COD:N, BOD:N and N:P. The COD:N ratio should be high enough to allow bacteria to grow both in anaerobic and aerobic reactors. However, as COD and BOD removal rates are low, further treatment is needed.

The next step is generally an aerobic treatment (see Section 4.5.3.1). An oxygen supply is made by either surface aerators or blowing air in at the bottom of the tank. When the waste water has a COD higher than 10000 mg/l, it is best not subjected to aerobic treatment alone. However, aerobic techniques are suitable for less polluted waste water, e.g. condensed vapours from concentration systems or washing and flume water from potato starch production. In particular, when treating condensed vapours, it is important to ensure a balanced nutrient ratio (N:P). In addition, waste water from starch modification can be expected to have extremely imbalanced, carbohydrate-based organic loads with possible problems due to rising and bulking sludge [65, Germany, 2002].

Finally, tertiary treatment includes biological nitrification/denitrification (see Section 4.5.4.1). It is reported that tertiary treatment is not always required.

The reported composition of waste water after treatment is given in Table 4.74.

Parameter	Concentration (mg/l)	
	Minimum	Maximum
BOD	5	20
COD	50	300
Suspended solids	10	60
Total nitrogen	2	50
Total phosphorus	1	5

Table 4.74: Characteristics of starch sector waste water after treatment [115, CIAA-AAC-UFE, 2002]

It is reported that waste water from starch installations is sometimes only subject to preliminary waste water treatment, such as sedimentation (see Section 4.5.2.5) and then it sent off-site for landspreading (see Section 4.1.6).

4.5.7.6.3 Re-use of process water in potato starch manufacturing

Description

Where starch and starch derivatives are manufactured from potatoes, large volumes of potato starch manufacturing waste water may be produced. A system for re-using the potato fruit water and process water is summarised in Figure 4.46.

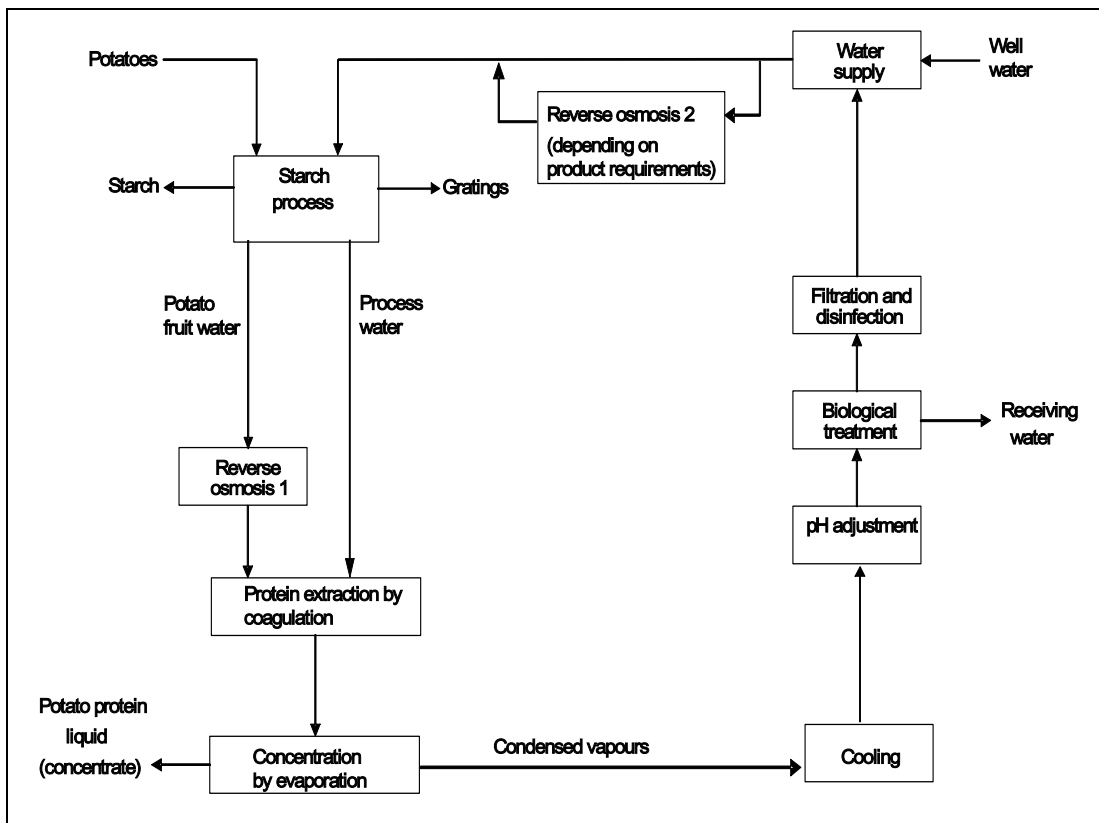

Figure 4.46: Water circuit in a potato starch installation

First the potato water is treated by RO. The treated potato fruit water is then sent, together with the process water, for protein extraction, by coagulation. The next process step is concentration by evaporation of the deproteinised potato fruit water and the process water. The condensed vapour obtained from this evaporation step is cooled and the pH is adjusted before being fed to the biological WWTP. Some of the purified water undergoes further treatment where it is first filtered through a sand filter and then disinfected. The water recovered is mixed with fresh water and returned to the production process. Optionally, depending on product requirements, a second RO step can be performed.

Achieved environmental benefits

Reduction in both fresh water consumption and waste water volume.

Cross-media effects

Increased energy consumption and surplus sludge production.

Operational data

In an example installation, the design characteristics of the evaporation step are shown in Table 4.75 and the biological waste water treatment characteristics are shown in Table 4.76.

Inlet	Total inlet flow	213 m ³ /h (on the basis of continuous feed)
	Process water from starch manufacturing	Flow volume 1 = 110 – 145 m ³ /h Dry matter content = 1.8 – 2 % Temperature Inlet protein unit = 38 – 40 °C After protein unit = 86 °C
	Coagulated potato fruit water from protein unit	Flow volume 2 = 100 – 115 m ³ /h Dry matter content = 5.5 – 6 % Temperature leaving protein unit = 86 °C ± 1 %
Output	Product	Potato protein liquid with at least 55 % dry matter
	Condensate	As cool and as pure as possible
Performance	Steam removal capacity	At least 230 t/h
	Pre-evaporator	At least 196 t/h
	Final evaporator	At least 34 t/h
	Concentration temperature	Maximum 87 °C
	Reserve capacity	At least 15 % in terms of steam removal capacity
	Operation cycle	Operating time at least 120 h Cleaning time maximum 9 h

Table 4.75: Concentration of potato starch process water by evaporation – design data

Waste water type	Condensed vapours from concentration unit	
Process	Activated sludge process Sand filter Disinfection	
Basic design data	Waste water volume	200 m ³ /h
	COD concentration	1500 ± 300 mg/l
	COD load	7200 ± 1440 kg/d
Waste water characteristics	COD	<25 mg/l
	BOD ₅	<10 mg/l
Characteristics of the activated sludge treatment 2 basins, each of 1375 m ³ (= 2750 m ³) aerobic volume including preceding selector	Hydraulic residence time	= 13.8 h
	Hydraulic load	= 1.75 m ³ /m ³ per day
	COD volume load	= 2.6 kg/m ³ per day
	Sludge concentration	= 5000 g/m ³
	COD sludge load	= 0.52 kg COD/kg dry matter per day
	Return sludge volume	= maximum 200 m ³ /h
Final sedimentation Secondary sedimentation 1 circular transverse-flow sedimentation basin	Diameter	=23 m
	Water depth	=5 m
	Volume	=2076 m ³
	Surface area	= 415 m ²
	Residence time	= 10.38 h
	Surface load	= 0.48 m/h
Sand filtration 3 units	In-feed flowrate	= (maximum) 3 x 70 m ³ /h
	Washing water flowrate	= (maximum) 3 x 70 m ³ /h
	Hydraulic load	= 8 m/h
Disinfection	UV disinfection and ClO ₂ metering	

Table 4.76: Biological waste water treatment characteristics in a potato starch installation

Applicability

Condensed vapours in the potato starch industry are highly degradable making the treatment by RO and evaporation stages dependent on the special properties of potato fruit water and process water.

Economics

The reduction in fresh water consumption reduces costs. It is reported that the cooling of treated condensed vapour may not necessarily be economical.

Driving forces for implementation

It is reported that the waste water had previously been disposed of by landspreading. This was not feasible because of the large volume produced, the high transport costs, and the high surface area requirement. The storage volume required using this method is small compared to landspreading, due to landspreading being limited to certain periods of time of the year. Unlike the landspreading option, this technique is independent of weather conditions.

Example plants

At least one installation manufacturing starch from potatoes in Germany.

Reference literature

[65, Germany, 2002]

4.5.7.7 Sugar

4.5.7.7.1 Waste water treatment

It is reported that depending on the configuration of the WWTP, waste water segregation (see Section 4.1.7.8) is sometimes carried out at sugar beet processing installations, before waste water treatment. The process water, i.e. the surplus condensate from the concentration, which is high in ammonia and the water from crystallisation; the fluming water and the wash-water are reportedly kept separate from the high strength fluming water. In some installations the condensate is used to wash beets.

Example 1

The soil is settled out from the transport water in sedimentation ponds (see Section 4.5.2.5). The decanted water is treated using both anaerobic and aerobic lagoons (see Section 4.5.3.1.4). The use of lagoons can make it possible to use the water to irrigate the land during dry weather, which also reduces the need for extracting water from the rivers or from the ground. For the treatment of process waters in southern Europe, it may be possible to use lagoons for natural water evaporation due to the high average temperatures.

Further treatment is needed if there is a risk of offensive odour or should the needs of the environment dictate a more stringent level of treatment. In this case, the previous treatment can be enhanced by surface aeration, possibly preceded by aerobic treatment (see Section 4.5.3.1).

Example 2

Should the environmental needs dictate that further levels of treatment are required, sedimentation (see Section 4.5.2.5), anaerobic treatment (see Section 4.5.3.2) followed by oxygenation and/or aerobic digestion (see Section 4.5.3.1) with a final sludge sedimentation process can be used.

The high strength supernatant passing from the sedimentation ponds is ideally suited for treatment using anaerobic techniques. Moreover, the betaines from the sugar beet, composed of organic nitrogen compounds, can only be degraded anaerobically. Consequently about half of the sugar factories in Germany are currently equipped with anaerobic systems [65, Germany, 2002].

The organic material in the fluming water breaks down into shorter chain organic acids. Historically, pH correction was made using additives such as lime in a neutralisation process (see Section 4.5.2.4). However, this “acidification” of the waste water stream is ideally suited for anaerobic treatment. “Acidogenesis” is an essential reaction that takes place in anaerobic conditions to break the longer chain organic material into more treatable organic acids. A number of anaerobic installations require an acidification tank upstream of the anaerobic reactor to initiate the acidogenesis stage. Hence pH correction of the fluming water is no longer required.

The biomethanation is undertaken at higher temperatures, e.g. 37 °C, although a lower rate of digestion can take place at 20 °C or less. Operating problems may occur as a result of changes in the composition of the organic constituents of the waste water and also its high calcium content.

In the methane reactor, the presence of calcium from the carbonation process which is present in the waste water in combination with the carbon dioxide formed in the reactor, leads to the precipitation of calcium carbonate. Experience shows that regardless of the concentration of the incoming waste water and regardless of the process used, the calcium content is reduced to around 0.3 – 0.7 kg/m³. This means annual calcium carbonate loads of 300 – 1000 tonnes remain in the reactor. This gives rise to problems with mixing in the system, and also to additional work and cost to keep the relevant pumps, heat-exchangers and pipes in good working order [65, Germany, 2002].

A portion of the anaerobically treated waste water can be recycled as fluming water. Furthermore, the methane produced as part of the anaerobic process can be used for drying beet pulp intended for use as animal feed. Low grade heat can be used to preheat the waste water entering the anaerobic reactor [13, Environment Agency of England and Wales, 2000].

Sugar processing excess condensate is considered to be high in ammonia content, yet low in COD. The recommended process for reducing the ammonia levels is to use aerobic techniques configured to allow for the nitrification of the ammonia (see Section 4.5.4.1). For this to take place, the waste water stream needs to be dosed with an external carbon source. For those installations using anaerobic techniques for treating the fluming water, combining the waste water from the anaerobic process with the excess process water is usually sufficient to provide a feed of adequate balance onto the aerobic treatment stage.

Some factories use hydrocyclones to remove lime-laden bacterial sludge from the system. In nearly all factories it is necessary, during the off-season period, to mechanically remove the lime that has formed in the reactors. This is carried out at regular intervals, every 2 – 5 years. The lime concentrations on removal are around 800 – 1000 kg/m³ of carrier material. Since such operations are seasonal, the aerobic system downstream of the anaerobic system must be activated accordingly at the start of the season. This is not necessarily the case with fluidised beds (see Section 4.5.3.2.7). Lime is precipitated almost entirely on the carrier material, which can then be drawn off during operation.

The final waste water from this stage may be of a high enough quality to be discharged to a watercourse. Alternatively, discharge would be to WWTP. For potential recycling of final waste water, tertiary treatment techniques (see Section 4.5.4) can be employed on some of the waste water.

Example 3

For those circumstances which demand additional control of nitrogen and its compounds, it is necessary to install suitably designed nitrification and denitrification systems. There are several biological and non-biological techniques, e.g. ammonia stripping (see Section 4.5.4.2) and biological nitrification/denitrification (see Section 4.5.4.1).

Example 4

First an anaerobic process is applied and the biogas produced is used as fuel. Later, an aerobic process is applied degrading nitrogen and phosphorus.

After waste water treatment, the water is either re-used in the factory or discharged into rivers or the open sea.

Example 5

Figure 4.47 shows a typical process flow diagram of the waste water treatment for a sugar beet processing installation.

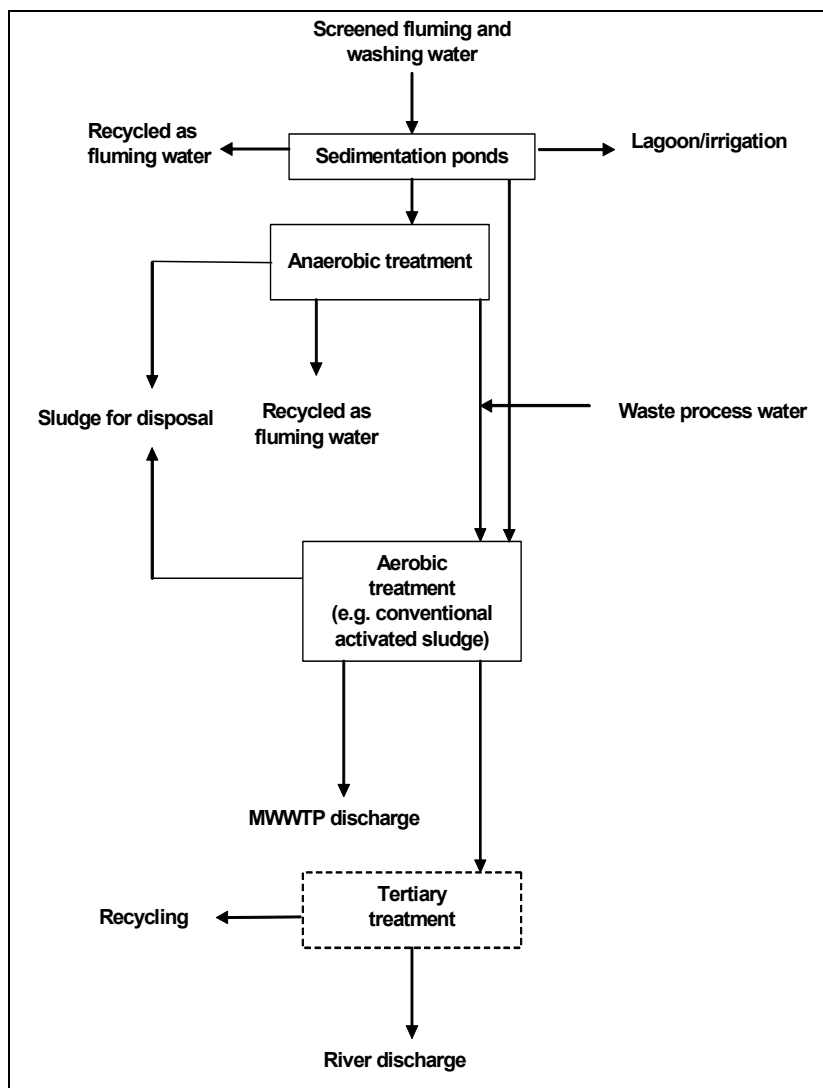

Figure 4.47: Typical options for treating sugar beet waste water
 [13, Environment Agency of England and Wales, 2000, 159, CIAA-CEFS, 2003]

Emission levels achieved

The performance of waste water treatment in a sugar industry of the Nordic countries is shown in Table 4.77.

Treatment	BOD (mg/l)	Total N (mg/l)	Total P (mg/l)
Before treatment	3300	120	10
After anaerobic treatment	100	80	8
After anaerobic and aerobic treatment	2	10	0.4

Table 4.77: Performance of waste water treatment in a sugar industry of the Nordic countries
 [1, CIAA, 2002]

Figures per tonne of sugar beet processed in Danish sugar installations are given in Table 4.78.

Parameter	Total Average (range)	No treatment Average (range)	After anaerobic/aerobic treatment
Waste water m ³ /t beets processed	0.79 (0.53 – 1.10)		
Waste water m ³ /t sugar produced	5.13 (3.73 – 6.98)	5.59 (3.76 – 6.98)	
BOD kg/t sugar produced	10.3 (0.01 – 24.4)	14.6 (10.7 – 24.4)	0.01
Suspended solids kg/t sugar produced	1.25 (0.76 – 1.62)	1.16 (0.76 – 1.42)	n/a
Nitrogen kg/t sugar produced	0.27 (0.01 – 0.56)	0.33 (0.19 – 0.56)	0.03
Phosphate g/t sugar produced	31.3 (0.81 – 83.2)	40.4 (27.5 – 83.2)	1.22

Table 4.78: Waste water production and main characteristics in Danish sugar installations [139, Nielsen E.H. Lehmann, 2002]

Specific loads for waste water contaminants after biological waste water treatment are shown in Table 4.79.

Parameter	Sugar produced (kg/t)
BOD ₅	0.24
COD	2.4
TOC	0.9
Nitrogen _{total}	0.35

Table 4.79: Waste water loads after biological treatment during a sugar beet processing campaign [152, Austria, 2002]

It is reported that waste water from sugar installations is sometimes not subject to waste water treatment, but is sent off-site for landspreading (see Section 4.1.6).

4.5.7.8 Drinks

4.5.7.8.1 Waste water characteristics

The soft and alcoholic drinks sector is a diverse sector. Its waste water can be divided into the categories low strength/high volume, high strength/low volume, continuous regular discharges and campaign/seasonal discharges. The waste water from this sector tends to be highly biodegradable and contain active micro-organisms.

4.5.7.8.2 Waste water treatment

Waste water segregation can be used prior to treatment (see Section 4.1.7.8). There may be potential for high volume/low strength streams to be either recycled (following suitable treatment), discharged directly to WWTP without treatment, or mixed with treated final waste water prior to discharge. The options available will depend on the receiving water and the consent to discharge [13, Environment Agency of England and Wales, 2000].

In general, when applying techniques for the treatment of waste waters from the soft and alcoholic drinks sector, the following primary processes can be used [13, Environment Agency of England and Wales, 2000]:

- screening (see Section 4.5.2.1)
- flow and load equalisation (see Section 4.5.2.3)
- DAF (see Section 4.5.2.6)
- diversion tank (see Section 4.5.2.7).

Biological treatment systems are used successfully in the soft drinks industry.

Depending on the product range and packaging system, e.g. returnable or non-returnable, constant or intermittent addition of nutrient salts may be necessary. Cleaning and disinfection may lead to temporary peaks in phosphorus concentrations, which may then cause problems for direct dischargers even after equalisation, which is reported to be advisable before biological treatment [65, Germany, 2002].

For waste water streams with a BOD concentration greater than 1000 – 1500 mg/l, anaerobic treatment processes can be used (see Section 4.5.3.2), followed by surface aeration. For lower strength waste water streams, aerobic treatment is used (see Section 4.5.3.1). A two-stage biological system (see Section 4.5.3.3.2), anaerobic followed by aerobic, may be used.

For discharges to watercourses, or to treat waste water to a quality suitable for re-use, further treatment stages are required.

If suspended solids discharge levels are low, or if the waste water is to be recycled, tertiary treatment (see Section 4.5.4) is required. Disinfection and sterilisation (see Section 4.5.4.8) is essential if the waste water is to be used in processing areas as drinking water.

Some installations operate all year round, but process seasonal produce. Such installations have general waste water generated all year round from the continuous production on-site and during the season or campaign, further waste water is generated from intensive processes. The nature of the general waste water and the campaign waste water, therefore, influence the waste water treatment techniques selected for the installation.

Typically, the campaign waste water is higher in strength than the general waste water and a number of factors will affect an operator's choice of techniques under these conditions, e.g. the proximity of the discharge points for the waste water streams and whether there is process benefit in combining the streams, or keeping them apart. The economics of constructing a waste water treatment plant capable of receiving significantly higher loads during a campaign may be considered.

Some waste water may require primary treatment only if treated separately, prior to discharge to a WWTP. The campaign/seasonal waste water is typically high in strength and comparatively low in volume and is treated using anaerobic processes. Final waste water from the anaerobic process may typically be discharged to a MWWTP, following surface aeration.

For treating the streams together, a WWTP must generally be of modular construction with two or more reactors working in parallel to allow for one reactor to be used out of season with the plant brought up to full capacity during the seasonal production. A technique considered for this is a conventional activated sludge process (see Section 4.5.3.1.1) with pure oxygen (see Section 4.5.3.1.2) supplementation during the high loads associated with the seasonal production. The plant may require artificial feeding in preparation for the increased flow and load.

4.5.7.8.3 Brewing

Usually, there are fluctuations in the generation of waste water. The peak flow can be in the order of 2.5 – 3.5 times the average flow, depending on how close to the production area the measurement is made. The period of peak flow is normally short. Peak flows occur in the brewhouse and beer processing area in connection with cleaning operations. In the packaging area, peak flows occur during closing down of the line as bottle washers and tunnel pasteurisers are emptied. A third area, where large peaks can occur, is in the waste water treatment area during backwash of filters.

The concentration of organic material will depend on the waste water to beer ratio and the discharge of organic material into the WWTP. The typical discharge of organic material from a brewery is normally in the range of 0.8 – 2.5 kg COD/hl beer. Larger discharges can occur and can be attributed to the discharge of surplus yeast, trub or other concentrated wastes into the WWTP that could be disposed of in better ways. Production of non-alcoholic beer may result in very high discharges if the condensed alcohol is discharged into the WWTP.

Normally, the process waste water has a low content of non-biodegradable components. Brewery waste water normally has a COD/BOD ratio of 1.5 – 1.7 indicating that the waste water is easily degradable.

During primary treatment, neutralisation (see Section 4.5.2.4) is essential. The dosing capacity of the neutralisation plant will depend on the operation of the brewery, especially the design and operation of the discharge of the caustic baths in the bottle washers and CIP tanks. Other alternatives are using flue-gases from the boiler plant or surplus CO₂ from the fermentation to neutralise caustic in CIP plants or overflow from bottle cleaning facilities. The equipment can be a scrubber or a simpler system with venting of the gas to a sump.

Secondary treatment can include aerobic (see Section 4.5.3.1) and/or anaerobic (see Section 4.5.3.2) processes. The most common aerobic method applied for brewery waste water treatment is the activated sludge process (see Section 4.5.3.1.1). Nevertheless, using an anaerobic process gives the advantage that less (or no) nutrient is needed for nutrient deficient brewery waste water. The most commonly used anaerobic techniques are the UASB (see Section 4.5.3.2.4) and the EGSB (see Section 4.5.3.2.8) reactors.

The excess sludge can be a significant part of the breweries' solid waste generation and must be disposed of. The use of sludge in land application has been reported (see Section 4.1.6).

If waste water requirements are more stringent than a BOD of 15 mg/l and an SS of 20 - 30 mg/l, tertiary treatment is necessary (see Section 4.5.4).

4.5.7.8.4 Water re-cycling in a brewery

Description

At the end of mash separation, the residual, very dilute worts, are allowed to freely drain until an acceptable level of brewers' grains moisture is achieved. After grains discharge, the fines deposited beneath the false floor are removed by a hot water underplate pressure cleaning and the false floor slots are kept unobstructed by an overhead hot water rinsing. These very dilute worts are high in SS, lipids and polyphenols and, traditionally, have been considered unacceptable for process re-use and are consequently sent to the WWTP. This loss is significant in terms of water, energy and extract.

Waste water from the lauter tun is a significant contributor to a brewery's total waste water. The strength of the lauter tun waste water depends on several factors. In terms of water balance, the lower the spent grain moisture content, the greater the waste water volume. It is advantageous to reduce further the volume of dilute wort drainings, but care is needed not to entrain air or extend the time of wort collection. It is also common practice to apply deep bed raking during the bed drain down to speed up the draining of the residual dilute worts after completion of the wort collection to the kettle. The more aggressively this technique is employed, the more fines pass through to the waste water. A higher level of retained spent grain after discharge, inevitably results in more fines/COD being entrapped in the false floor plate and removed by the underplate pressure cleaning and going to the waste water.

To enable the re-use of the waste water as process water for mashing, the removal of the very fine colloidal size particles from the weak worts is necessary. This can be achieved by centrifugation or two-stage filtration, i.e. coarse filtration followed by ultrafiltration. After the coarse filtration stage, the waste water is subject to a cross-flow membrane process.

Achieved environmental benefits

Reduced levels of SS and COD in the waste water.

Operational data

An example UK brewery developed a pilot plant to deal with a specific high strength waste water separately from the rest of the waste water. The lauter tun produced approximately 20 % of the total waste water load of the brewery, as shown in Table 4.80.

Parameter	Concentration		Contribution of the lauter tun to the total load (%)
	Total brewery waste water (mg/l)	Lauter tun waste water (mg/l)	
SS	800	6540	27
COD	2000	13100	22

Table 4.80: Waste water characteristics in a brewery

Before ultrafiltration can commence, it is necessary to remove coarse particles sized greater than 100 μ . 70 % of the suspended solids are easily settleable and likely to be removed by coarse filtration. Different in-line self-cleaning filters were trialled. Various screen sizes were used with this unit and 30 μ mesh was found to be optimal for solids removal with acceptable water content, i.e. 75 % moisture. These were versatile enough to cope with the variable solids loadings of the influent and also provided a discharge acceptable for disposal with the normal brewers' grains, rather than creating a new solid waste stream for disposal.

After the coarse filtration stage, the waste water is subject to a cross-flow membrane process. The resultant concentrate is still very liquid at less than 1 % dry solids. If this was added to the normal wet brewers' grains at 75 % moisture, the overall moisture content would increase to 78 %. For a worst case scenario, this was assumed to be unacceptable and therefore the concentrate would have to go to the WWTP. The cross-flow membrane filter retained 99 % of the SS and 53 % of the COD, allowing for a 5-fold concentration effect.

The permeate post UF has undergone a 99 % reduction in suspended solids, a 45 % reduction in polyphenols and a 99 % reduction in lipids. This can reportedly be used as a 1 to 3 substitute for hot mashing water in the process. This results in an increase by 13 mg/l in polyphenols and 1 mg/l in lipids. This is reported to be considered an acceptable process variation. The reduction in pollution load is summarised in Table 4.81.

	Lauter tun waste water	30 μ filter waste water	Ultrafiltration 100 nm	
			permeate	concentrate
Volume (m ³)	13	13	10.5	2.5
Total solids (mg/l)	6540	3110	38	16010
COD (mg/l)	13100	13100	7623	36104

Table 4.81: Summary of the pollution reduction results treating lauter tun waste water

Economics

It is reported that in the UK most breweries discharge their waste water into a MWWTP for treatment. A charge is made for this service by the MWWTP, which is usually a water company. The total cost of the treatment of the lauter tun has been estimated to be about GBP 97/brew. Assuming 3000 brews in a year this amounts to about GBP 291000/yr.

The reduced COD loading to the MWWTP reduces the waste water cost by about GBP 13 per brew. The permeate used as mashing water results in a saving in hot water, which is only actually achieved with an appropriate brewhouse hot liquor balance. In this instance, the recovered hot water still required water make up. The estimated total savings were about GBP 59/brew, or about GBP 176000/yr. Annual running costs were estimated to be about GBP 28000, therefore the net savings were estimated to be about GBP 50000. The installation costed about GBP 300000, and therefore the payback period is estimated to be 2 years. An additional annual saving of GBP 50000 would be realised if the UF concentrate was to be loaded with the normal brewers' grains instead of being sent to the MWWTP.

The cost of such an installation will vary significantly from brewery to brewery, depending upon the lauter tun size, flowrates, buffer tank requirement, solids disposal route and degree of automation. In the pilot, from which these economic data were derived, the technique was not integrated into the automated control system of the brewery, nor was it connected to the CIP system. Although these factors may alter the economic assessment, it is reported to be likely that implementation of the lauter tun waste water treatment system would have an attractive financial payback period of 1 – 2 years.

Reference literature

[102, UK, 2002]

4.5.7.8.5 Distilling

It has been reported that in a molasses distillery, a two-stage (see Section 4.5.3.3.2) waste water treatment system, anaerobic following aerobic, is used. The main treatment is an EGSB reactor (see Section 4.5.3.2.8) in which the organic load is largely degraded to methane gas, which may be used on-site and only small quantities of sludge are produced. The COD and nitrogen loads are then reduced further in an activated sludge reactor (see Section 4.5.3.1.1).

Figure 4.48 shows a flowchart and dimensions of the anaerobic/aerobic waste water treatment system at a distillery.

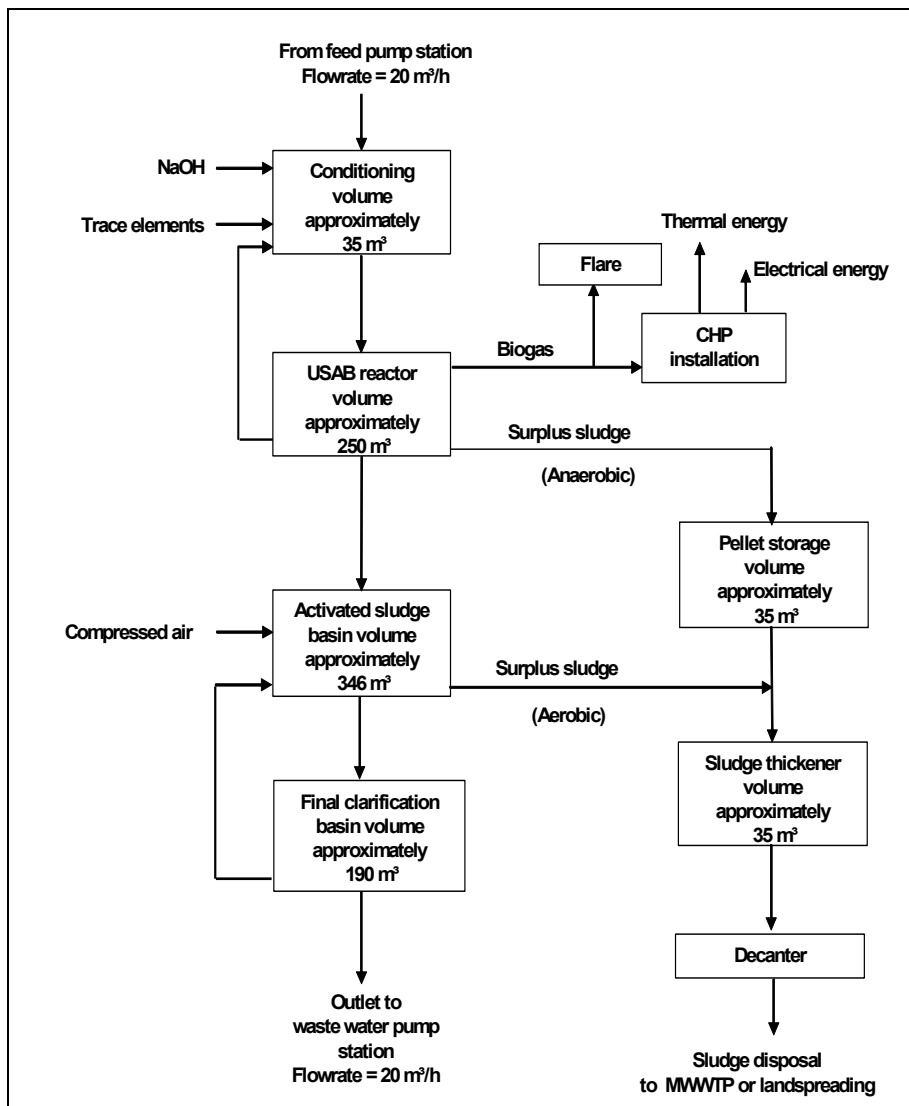

Figure 4.48: Anaerobic/aerobic waste water treatment system at a distillery [65, Germany, 2002]

4.5.7.8.6 Wine

Residual solids, e.g. grape or pomace residues, filter cakes and sediments which are not removed at source, can be removed by screening. The use of landspreading (see Section 4.1.6) and evaporation lagoons (see Section 4.5.3.1.4) have been reportedly used in vineyards.

Primary treatment is used to remove easily decanting SS. The following techniques can be used:

- screening (see Section 4.5.2.1)
- flow and load equalisation (see Section 4.5.2.3)
- neutralisation (see Section 4.5.2.4)
- sedimentation (see Section 4.5.2.5)
- centrifugation (see Section 4.5.2.8)
- precipitation (see Section 4.5.2.9).

After primary treatment, the waste water may be sent to the MWWTP if acceptable, or further treated on-site. During secondary treatment, the yeast can provoke severe problems; the activated sludge can die and be washed out. Therefore, the separation of yeast and other solids is a necessary primary treatment step.

Anaerobic processes (see Section 4.5.3.2) and particularly anaerobic lagoons (see Section 4.5.3.2.1) and anaerobic filters (see Section 4.5.3.2.3) are reported to be the most suitable treatments for winery waste water. Alternatively, aerobic processes (see Section 4.5.3.1) can be used, e.g. aerated storage for three months is used at small wineries with low waste water volumes. Activated sludge (see Section 4.5.3.1.1) or trickling filters (see Section 4.5.3.1.5) are used. Activated sludge systems tend to be over dimensioned, due to the seasonal variations and are, therefore, expensive to install and operate. Trickling filters are reported to be 70 % effective and, therefore, require further polishing.

Tertiary treatment (see Section 4.5.4) is used as a polishing stage for remaining pollution removal.

4.5.7.9 Citric acid

The waste water generated from citric acid manufacture has a high COD; compounds containing calcium and sulphur derived from precipitation and decomposition and a high concentration of $\text{NH}_4\text{-N}$ from the raw material (molasses) and fermentation. About 25 % of the crude waste water volume is highly polluted and represents about 90 % of the total COD load.

The highly polluted waste water is first pretreated using anaerobic digestion, which produces biogas with a high sulphur content. The waste water treated in the anaerobic reactor and the other waste waters are then mixed and treated further. Waste water emission levels, after treatment, per tonne of installed production capacity are shown in Table 4.82.

Parameter	Unit	Average value
Volume	m^3/t	40
COD	kg/t	20
BOD_5	kg/t	1
$\text{NH}_4\text{-N}$	kg/t	0.2
$\text{NO}_3\text{-N}$	kg/t	0.08
$\text{PO}_4\text{-P}$	kg/t	0.04

Table 4.82: Treated waste water emission levels per tonne of installed production capacity in citric acid fermentation
[151, Austrian contribution, 2002]

4.6 Prevention of accidents

One of the most significant potential environmental impacts associated with an FDM manufacturing site is an accident which could pollute the environment, this is usually characterised by an accidental release of material directly to air, water or land, although it may also be a failure that leads to the generation of otherwise avoidable waste. For example, the accidental release of the contents of a tank containing raw material, e.g. milk; or product, e.g. vegetable oil, or an auxiliary material such as, ammonia, can have a significant detrimental impact on a local watercourse or water supply. Such accidents may occur during routine or non-routine operations.

There are a number of stages in the management of accidental releases and they are described in Sections 4.6.1 – 4.6.6. In summary, these stages are:

- identify potential accidents that could pollute the environment
- conduct a risk assessment on the identified potential accidents to determine their probability of occurrence and potential specific type and severity of harm to the environment
- develop control measures to prevent, eliminate or reduce, to an acceptable level, the risks associated with identified potential accidents
- develop and implement an emergency plan
- investigate all accidents and near misses, to identify their causes and take action to prevent recurrence.

4.6.1 Identification of potential accidents

Description

Accidents may occur as the result of, e.g.

- loss of containment from bulk storage, e.g. leakage, spillage and vessel failure
- loss of containment from in-process control failures
- failure or malfunction of end-of-pipe abatement techniques
- failure of utilities supply, e.g. water or electricity.

Information about potential accidents identified can then be used to assess the risk (see Section 4.6.2).

Information that can be used includes, e.g.

- (a) Information about substances on site

The potential for accidents is significantly influenced by the raw materials, auxiliary materials, intermediate products, products and the waste on the site, so it is important to:

- maintain an inventory of substances. It may be a legal requirement to provide this to the emergency services
- assess their potential environmental (and safety) hazards. A good source of safety and environmental information is material safety data sheets, which are supplied by the substance supplier and product data sheets, which are normally developed internally within the company
- information on quantities stored on-site and their location.

- (b) Identification of the emissions from unit processes/emission inventory

It is important that all streams/emissions or potential streams/emissions which could give rise to an abnormal occurrence/accidental release are identified.

The most systematic way to do this is to work through each process and identify all the potential emissions. This will typically include:

- raw material delivery
- bulk raw material storage
- minor raw material storage, egg drums, sacks, intermediate bulk containers
- production
- packaging
- palletising
- warehousing.

As well as considering the processes, the ancillary equipment/processes on the site will also need to be considered. This will typically consist of:

- utilities, e.g. boiler house, compressed air, water treatment, ammonia systems
- internal transport on the site, e.g. forklift trucks.

Possible scenarios that may result in an accidental sudden increase in the noise levels at the site boundary are also considered.

(c) Installation/site plan

The installation/site plan is used to show the site drainage system and control/abatement mechanisms already in place; the location of bulk storage and drum storage facilities for materials stored in bulk and for materials that are particularly hazardous; transfer systems, such as pipelines for hazardous substances; major air emission points and sensitive boundaries and receptors. It is important that the plan is kept up to date.

(d) Location in relation to environmental receptors

Depending on the substance released due to an accident, the harm may be considered as a global issue or the pollution impact may only be significant within an area surrounding the installation. To understand the potential environmental impact an accidental release may have, it is important to have knowledge of the local environment situation. Although there are areas of similarity between sites, there will also be differences, e.g. installations located in rural areas, residential areas and industrial areas are likely to have different environmental issues. Accidental releases of air emissions, odour and sudden increases in noise levels are all likely to be key issues for installations located close to residential areas, whereas the impact on the local watercourses and wildlife may be more of a concern in rural areas. Public amenities will need to be considered, particularly where surface water or treated waste water is discharged into a local river or where there is potential for groundwater contamination.

In addition, it is useful to have a basic knowledge of the geology and hydrogeology of the area on which the installation is built. If it is located on clay soils, then a spillage will take a longer time to permeate through to groundwater beneath it than if it is on sandy or permeable soil.

A site survey can identify all the environmental receptors for the site and identify any which are particularly sensitive, e.g.

- a receiving watercourse collecting treated water and/or surface water
- housing on the site boundary
- a local tourist attraction adjacent to the site
- local schools/hospitals
- sensitive aquifers
- sites of specific scientific interest
- an area of outstanding natural beauty.

(e) Site history

The objective in documenting the site history is to demonstrate that a site is free from environmental problems which might arise from past activities. The information gathered can also provide a baseline from which to assess the impact of any accidental releases that may occur in the future.

The main issue is normally one of contaminated land or contaminated groundwater. This can arise from sources such as underground storage tanks, poor bunding and spill protection, on-site landfilling or leaking drains. By documenting the past land use, areas where contamination might have occurred can be identified and, if necessary, investigations involving soil/groundwater sampling and analysis can be undertaken. Investigations of this type are typically only carried out if it is believed that there is a reasonable risk that the land or groundwater is contaminated.

(f) Other information

Other factors which assist in the identification of potential sources of environmental incidents include:

- previous incidents including near misses
- technological and management/operational controls that are in place and the potential failure of these controls
- human behaviour; the interaction between operators and manufacturing operations and the potential of an environmental incident occurring due to human behaviour.

(g) Structured techniques

Structured techniques can be used to identify potential accidents. These techniques examine in detail flow diagrams of the manufacturing operation under study. HAZOPS (Hazard and Operability Studies), FMEA (Failure Mode and Effects Analysis) and SWIFT (Structured What-IF Technique) are examples of such methods. These techniques can be time consuming and resource intensive and are typically not used for installations where processes and unit operations are relatively simple.

Achieved environmental benefits

Reduced risk of accidents which may pollute the environment.

Applicability

Applicable in all FDM installations, however, if potential accidents are identified at the design stage of an installation, their prevention can be more easily and economically incorporated than if they are added later.

Driving force for implementation

Reduced risk of accidents which may pollute the environment.

Example plants

Widely applied.

4.6.2 Risk assessment

Description

A risk assessment is an important part of the management procedure, as it is the application of this technique which will determine whether managers consider whether there is a significant risk of an accident occurring.

The depth and type of risk assessment carried out will depend on the characteristics of the installation and its location. The scale and nature of the activities taking place at the installation under investigation and the risks to the environment, including to people, need to be taken into account.

A hazard is anything with the potential to cause harm. A risk is the likelihood that a hazard will cause a specified harm to someone or something, i.e. whether the chance is high or low, that harm will be caused by the hazard.

(a) Severity

Some examples of severity, using a 0 – 4 scale, where 4 is the highest level of severity, are:

- a spillage of solid on-site that is completely contained and can be used would not cause any environmental harm so would be scored 0
- if the spillage caused very short term and low severity contamination of part of the land on-site, this would score 1. However, if the spillage penetrated into groundwater, and could cause damage on a regional scale by polluted water supplies, the score would be between 2 and 4 depending on the pollutant, the quantities involved and the sensitivity of the groundwater, e.g. is it being used as a source of drinking water
- if the spillage entered the surface water drainage system, then there could be minor, moderate or major damage to the local environment. Depending on the scale and toxicity of this release it would score 2, 3 or 4.

(b) Probability

The probability of occurrence depends on whether all the precautions necessary, e.g. by law and accepted as, e.g. national, international or industry standards are already in place and maintained, for the installation-specific processes and operations. The probability can also be given a score, e.g. on a 1 – 5 scale, where 5 is the highest probability.

(c) Overall risk assessment

The overall level of risk is obtained by multiplying the severity by the probability.

Application of an assessment allows a systematic analysis of the potential accidents to be made and helps prioritise risk control measures, making sure that the most important risks are tackled first.

Achieved environmental benefits

Reduced risk of accidents which may pollute the environment.

Operational data

Risk assessments become out of date when technological or operational conditions change. To ensure they are effective, they need to be updated periodically and when significant changes occur at the installation, such as the introduction of new unit operations.

Public sensitivity does not necessarily correlate with environmental harm or legal compliance. It is more likely to be assessed based on the number of complaints from the public and the regulatory authorities, and the interest shown by these parties over the activities associated with the site.

Applicability

Applicable in all new and existing FDM installations.

Driving force for implementation

Reduced risk of accidents which may pollute the environment.

Example plants

Widely applied.

4.6.3 Identify potential accidents which need to be controlled

Description

Once the risk assessments have been completed, it is then necessary to identify accidents that may have a significant environmental impact and which are currently not adequately controlled. This is done using the results of the risk assessment. The scoring system can be used to identify priorities for action. These may change with time as part of a continuous environmental improvement programme.

Achieved environmental benefits

Reduced risk of accidents which may pollute the environment.

Applicability

Applicable in all new and exiting FDM installations, however, if potential accidents are identified at the design stage of an installation, their prevention can be more easily and economically incorporated than if they are added later.

Driving force for implementation

Reduced risk of accidents which may pollute the environment.

Example plants

Widely applied.

4.6.4 Identify and implement control measures needed

Description

An evaluation has to be undertaken on the identified sources of potential accidents to determine whether new control measures are required or existing control measures need to be improved.

Typical control measures that can be considered are:

- management procedures
- operational procedures
- preventative techniques
- containment
- process design/process control.

(a) Management procedures

Management system procedures can be put in place to assess new activities on the site and to ensure that environmental issues, including the possibility of accidental releases, have been taken into account. These procedures may include:

- procedures to assess the environmental risk associated with new raw materials
- ensuring adequate control measures are in place
- checking compatibility with other materials and feedstocks with which they may accidentally come into contact
- implementing procedures to assess new processes to ensure adequate control measures are incorporated at the design stage to prevent or minimise accidental releases.

(b) Operational procedures

Operational procedures need to be developed covering critical process plant items to ensure that the risk of accidents is minimised.

Operator instructions for the process plant include, e.g.

- carrying out routine checks on potential sources of accidental releases and any control measures that may be in place
- carrying out regular checks on pollution abatement equipment such as bag filters, cyclones and waste treatment facilities
- carrying out regular inspections of underground storage tanks and containment bunding.

(c) Preventative techniques

One example is:

- incorporating suitable barriers to prevent damage to equipment from the movement of vehicles.

(d) Containment

These measures may include:

- applying bunding for bulk storage of materials
- using spillage equipment to minimise impact of an accidental release
- isolating drains
- the containment or abatement of accidental releases from safety relief valves or bursting discs.

(e) Process design/process control

The process plant needs to be designed and controlled so that the risk of accidental releases of material are either eliminated or minimised to acceptable levels.

Process design/control measures may include:

- applying techniques to monitor the efficiency of abatement equipment, e.g. pressure drop across bag filters
- applying techniques to prevent the overfilling of storage tanks, e.g. level measurement, high level alarms and high level cut-off controls.

Achieved environmental benefits

Reduced risk of accidents which may pollute the environment.

Applicability

Applicable in all new and exiting FDM installations.

Driving force for implementation

Reduced risk of accidents which may pollute the environment.

Example plants

Widely applied.

4.6.5 Develop, implement and test an emergency plan

Description

Emergency procedures/plans need to be developed and put in place to ensure that, if an event does occur, the normal situation can be restored with a minimum effect on the environment. If the plan is not tested, it may not work properly if an accident occurs and it is needed. If conditions on the site or responsibilities are changed, then the emergency plan will need to be revised.

Normally, emergency plans need to be drawn up for the whole site and they cover safety and significant environmental risks. Emergency procedures covering the significant environmental risks identified can then be incorporated into the overall emergency plan.

A typical emergency plan covering environmental incidents includes the following components:

- roles and responsibilities of individuals need to be clearly defined including:
 - procedures for operators who remain to operate critical plant operations
 - escape procedures and routes
 - procedures to account for all employees
- assignment of rescue and medical duties
- procedures for reporting emergencies and informing relevant environmental authorities and emergency services need to be put in place/agreed
- action needs to be taken to minimise the impact of any environmental incident
- names of employees need to be listed.

For example, it is recommended that emergency procedures are in place to cover incidents which might involve the accidental release of the following:

- ammonia
- liquid raw materials or product stored in bulk, e.g. edible oil and milk
- dust from drying operations, such as spray drying
- potentially hazardous auxiliary materials, e.g. biocides and diesel oil.

The main aim of an emergency plan is to restore the normal conditions as quickly as possible with the minimum effect on the environment. Emergency situations vary greatly in scale and complexity and it is important that emergency plans are flexible enough to deal with the minor as well as major events and that they are also simple enough to be quickly implemented.

The effects of potentially catastrophic incidents can be substantially reduced by systematically preparing, and regularly thoroughly testing, plans with informed and trained people. There is not enough time during an emergency to decide who is in charge, to survey outside agencies to identify sources of help, or to train people for emergency response. These must be provided for before an emergency situation occurs.

Some other reasons for preparing emergency plans are:

- reducing the thinking time once an accident has occurred can significantly reduce its consequences, in terms of, e.g. injuries to people, damage to property, environmental effects and loss of business
- to ensure that the situation is orderly, rather than chaotic
- to reduce bad publicity, since serious accidents can have a bad impact on an organisation's image and subsequently on sales and public relations
- to fulfil legal requirements. Emergency plans are required in many countries
- to enable provisions to be in place for informing external agencies, the general public, the media and company senior management.

The emergency plan can also ensure that appropriate control techniques are put in place to limit consequences of any accident, such as oil spillage equipment, isolation of drains, alerting of relevant authorities, evacuation procedures, etc.

Achieved environmental benefits

Minimising the pollution resulting from accidents.

Applicability

Applicable where there is a significant risk of pollution occurring from an accident.

Driving force for implementation

Minimising the pollution resulting from accidents, limiting the damage to a company's image after an accident and limiting the various costs associated with restoring the site and legal fines and liabilities.

Example plants

Widely applied.

4.6.6 Investigate all accidents and near missesDescription

Lessons can be learned from investigating all accidents and near misses. The reasons for the accidents and near misses occurring can be identified and action can be taken to prevent them from happening again. If near misses are not investigated, the opportunity to prevent an accident may be missed. Keeping records can help to ensure actions are taken and preventive controls are maintained.

Achieved environmental benefits

Reduced risk of accidents which may pollute the environment.

Operational data

An example of a near miss is someone noticing that an empty storage tank valve has been left open, but with sufficient time to close it before the tank is refilled. Introducing and using a technical or operational solution to prevent this may prevent a future accident involving liquids being pumped into an open tank and directly to the WWTP or spilling into a yard and then to surface and/or groundwater. Waste generation and accidental releases are both then prevented.

Applicability

Applicable in all new and exiting FDM installations.

Driving force for implementation

Reduced risk of accidents which may pollute the environment.

Example plants

Widely applied.

4.7 Techniques applicable in some individual sectors**4.7.1 Meat and poultry****4.7.1.1 Segregation of outputs, to optimise use, re-use, recovery, recycling and disposal (and minimise water use and waste water contamination)**

This technique is described in Section 4.1.7.6.

Reported examples of where the technique is applied

There are likely to be many other opportunities to apply this technique within the sector.

- apply dry collection of all solid wastes by means of trays or baskets to prevent them from falling on the floor and entering the WWTP
- many raw materials are received or transported/stored in open vats or trolleys. A quantity of meat juice collects in the bottom of such containers. Rather than emptying this juice into the WWTP and therefore, increasing the pollution of the waste water, it is used in the manufacturing of processed meat products
- cutting and deboning operations usually take place after chilling. After chilling, the carcasses are more easily handled, cut and deboned. The bones are separated from the meat and together with meat scraps and fats, not intended for human consumption, are collected in trays fixed to the equipment and sent for treatment or disposal at animal by-products installations.

Applicability

Applicable to meat manufacturing installations.

Reference literature

[41, Nordic Council of Ministers, 2001]

4.7.1.2 Dry cleaning

This technique is described in Section 4.3.1.

Reported examples of where the technique is applied

There are likely to be many other opportunities to apply this technique within the sector.

- when ground meat residues, particularly meat mix for salami production or from sausage making, from equipment such as bowl choppers, sausage fillers and from floors, is left standing, it sticks to the surfaces and makes subsequent cleaning difficult. Cleaning such equipment immediately after the end of production minimises the cleaning efforts and the need for water and detergents. The ground meat residues are manually removed to the maximum practical extent, prior to cleaning and sending for rendering
- applying dry cleaning of meat scraps during trimming and cutting operations to reduce the waste water pollution load
- fit covers for the drains with adequate hole diameters to stop meat scraps entering the WWTP.

Applicability

Applicable to meat manufacturing installations.

Reference literature

[41, Nordic Council of Ministers, 2001]

4.7.1.3 Minimise the production and use of flake ice

Description

When processing ground meat, flake ice is often used to cool the meat mixture. By using a suitable mixture of chilled and frozen raw materials, it is possible to avoid the use, and therefore the production, of flake ice. Sometimes flake ice is added when processes such as chopping make the temperature of the meat rise, so causing a risk to the hygiene or the quality of the product or if only a small amount of water needs to be added to the product.

Achieved environmental benefits

Reduced water and energy consumption.

Applicability

Applicable in ground meat processing installations.

Reference literature

[41, Nordic Council of Ministers, 2001]

4.7.2 Fish and shellfish

4.7.2.1 Segregation of outputs, to optimise use, re-use, recovery, recycling and disposal (and minimise water use and waste water contamination)

This technique is described in Section 4.1.7.6.

Reported example of where the technique is applied

There are likely to be many other opportunities to apply this technique within the sector.

- apply dry collection of all solid wastes by means of trays or baskets to prevent them from falling on the floor and entering the WWTP.

Applicability

Applicable to all fish and seafood processing installations.

Reference literature

[134, AWARENET, 2002]

4.7.2.2 Dry cleaning

This technique is described in Section 4.3.1.

Reported example of where the technique is applied

There are likely to be many other opportunities to apply this technique within the sector.

- dry systems for collecting solid waste from crustaceans and molluscs, such as screens and efficient recovery systems prevents it from entering the WWTP and can reportedly lead to BOD₅ level reductions of up to 35 %.

Applicability

Applicable to all fish and seafood processing installations.

Reference literature

[134, AWARENET, 2002]

4.7.2.3 Use only high quality fishDescription

When the fish quality is poor, soft fillets can get caught in the skinning knife. This decreases the yield of the process and increases the generation of by-products and waste production. Skinning of fatty fish releases large quantities of oil to the waste water, amounting to about 1/3 of the overall COD load. Water is used to clean and lubricate the machinery. Maintaining the sharpness of skinning knives also makes a significant contribution to efficient skinning and waste minimisation.

Fish can deteriorate under the anaerobic conditions present during storage on the fishing vessel, so ensuring rapid delivery and processing, as well as providing storage conditions which maintain quality, contributes to maintaining high quality. The fish are stored in ice, while at sea. On land, they may be stored on ice and sometimes in refrigerated storage. The method of storage may depend on the time interval between the fish being caught and subsequent processing (see also Section 4.1.7.3). High quality fish can be selected for fillets and lower quality fish can be used, e.g. in fish-meal and fish-oil production. Broken fish may be used for food which does not require the appearance of whole fillets, such as moulded products and soups.

The successful application of this technique depends on collaboration with the operators of the fishing vessels and intermediary holders of the fish, such as wholesalers and hauliers.

Achieved environmental benefits

Reduced waste generation.

Cross-media effects

Energy may be required for storage.

Applicability

Applicable in fish processing.

Driving force for implementation

Reduced waste generation.

Reference literature

[28, Nordic Council of Ministers, 1997, 134, AWARENET, 2002]

4.7.2.4 Transport of skin and fat from the skinner drum by vacuum

Description

This technique consists of a suction device which sucks the skinner drum clean of skin and fat. Water is only used to moisten the drum to maintain the sucking effect.

Achieved environmental benefits

Reduced water consumption. Reduced waste water pollution.

Cross-media effects

Energy consumption.

Operational data

Both COD load and water consumption are reduced by 95 – 98 %. The need for water for both transport and routine rinsing is removed.

Applicability

Applicable in the fish sector, e.g. during skinning.

Economics

Savings in waste water treatment.

Example plants

Used in the Danish herring industry (see Section 4.7.2.9.1).

Reference literature

[Nordic Council of Ministers, 1997 #28; Ministry for the Environment, 2001]

4.7.2.5 Removal and transport of fat and viscera by vacuum

Description

In skinning and cutting, enclosed systems are applied for transporting fat and viscera to collection facilities. The fat and viscera are removed from the fish by vacuum and not with water. The sucking equipment consists of a vacuum ending in a specially designed sucking nozzle placed immediately after the head cut.

Achieved environmental benefits

Reduced water consumption. Reduced waste water pollution. Waste minimisation, e.g. by-products can be sold for fish-meal production.

Cross-media effects

Energy consumption and noise pollution.

Operational data

Reductions of 30 to 50 % of the pollution load are achieved. The energy consumed is higher than for the traditional removal of the head by cutting and washing out the viscera.

Applicability

Applicable in the fish sector, e.g. during cutting, eviscerating and filleting. The technique was applied in herring filleting, but abandoned due to the energy consumption and noise.

Economics

Savings in waste water treatment. As the by-product has a lower water content, it can be sold at a higher price.

Example plants

Used in mackerel processing in the Nordic countries.

Reference literature

[28, Nordic Council of Ministers, 1997, 134, AWARENET, 2002]

4.7.2.6 Dry transport of fat, viscera, skin and fillets, incorporating mesh conveyors

Description

Instead of using transport water in filleting, skinning and fat and viscera removal, a conveyor can either be set up under each line or a single filtering conveyor can serve all the machines. The dry transport is carried out by a chute with a 20 % slope mounted under the gutting wheel. Here viscera, fatty belly strips and the water from the wheel are caught. The method used on a filleting machine is shown in Figure 4.49. From the chute, viscera strips and water slide on to a fine meshed synthetic cloth conveyor belt, through which the water is drained. The viscera are transported to a container.

In filleting of white fish, dry transport is carried out by a filter conveyor with a mesh size of 0.25 mm. The water from the machines and small particles pass through the filter, while solids, e.g. fat and viscera, are retained. To keep the equipment clean and preserve filter capacity, it may be necessary to mount a water spray system. The filtrate can be used as spray water.

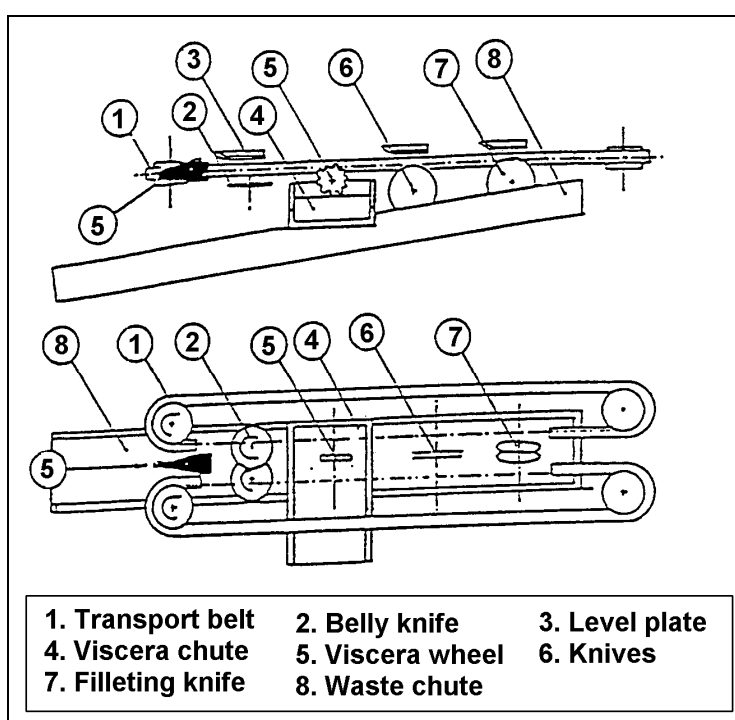

Figure 4.49: Equipment used for the dry removal of viscera

Achieved environmental benefits

Reduced waste water pollution load. Waste minimisation, e.g. a large amount of saleable by-product is collected, which can be sold for fish-meal production.

Cross-media effects

Water consumption, e.g. for cooling the equipment's knives and wheels, for cleaning the filter belt, and for cleaning the belly cavity. Energy is consumed.

Operational data

The pollution load of the waste water is reduced by 29 – 52 %, as shown in Table 4.83.

Parameter	Wet (kg/t raw herring)	Dry (kg/t raw herring)	Reduction (%)
Total nitrogen	1.4	0.99	30
Total phosphorus	0.17	0.12	29
COD	26.3	15.0	43
Dry material	17.8	10.9	39
Oil	7.3	3.5	52

Table 4.83: Discharge data before and after introduction of dry removal and transport of viscera

Filter conveyors under filleting machines are estimated to decrease the total COD discharge by about 5 – 15 % if the installation has a central filter conveyor or about 15 – 25 % if it has a drum sieve.

Applicability

Applicable in the fish sector, e.g. during skinning, evisceration, filleting and cutting.

Economics

Savings in waste water treatment. As the by-product has a lower water content, it can be sold at a higher price.

Example plants

Used in the Danish herring industry (see Section 4.7.2.9.1), in whitefish processing in the Nordic countries and in the fish processing industry in the UK (see Section 4.7.2.9.2).

Reference literature

[28, Nordic Council of Ministers, 1997, 58, Envirowise (UK), 1999]

4.7.2.7 Avoiding scaling if the fish is subsequently skinned

Description

Scaling equipment consists of a perforated rotating drum onto which water is applied to flush scales away. If the fish is subsequently skinned, scaling is not carried out.

Achieved environmental benefits

Reduced water consumption. Reduced energy consumption.

Operational data

Water savings of 10 – 15 m³/t are achieved.

Applicability

Applicable in the fish sector.

Reference literature

[134, AWARENET, 2002]

4.7.2.8 Using the filtered recirculated scaling waste water for preliminary fish rinsing

Description

Scaling equipment consists of a perforated rotating drum onto which water is applied to flush scales away. Using the filtered recirculated scaling waste water for preliminary fish rinsing minimises overall water consumption. Proper adjusting of the scaler operation, by weighing the amount of scales for a specific water flow, is also carried out.

Achieved environmental benefits

Reduced water consumption.

Operational data

Water savings of up to 70 % are reported.

Applicability

Applicable in the fish sector.

Reference literature

[134, AWARENET, 2002]

4.7.2.9 Case studies**4.7.2.9.1 Herring processing in Denmark**Description

Before early 1990, the Danish fishing industry was characterised by a large consumption of water and a large discharge of organic material to the waste water. From early 1990 until 1997, the industry applied cleaner technology techniques, as shown in Table 4.84, and achieved a water consumption and organic discharge reduction of up to 20 – 30 % of the original load.

Process	Measure	Target
Sorting	Exchange of water nozzles (see Section 4.1.8.8)	Water consumption
Eviscerating	Dry process for removal and transport of fat and viscera (see Section 4.7.2.6)	Energy, organic and nutrient pollution of waste water, re-use of waste
Filleting	Better use, removal and/or replacement of water nozzles (see Section 4.1.8.8)	Water consumption
Skinning	Transport of skin and fat from skinner drum by vacuum (see Section 4.7.2.4)	Water consumption, organic pollution of waste water

Table 4.84: Techniques applied in the herring filleting industry to reduce water consumption and waste water pollution

Furthermore, in the period from 1997 to 2000, the installations involved in the study increased their product refinement and shifted from discharging waste water directly to receiving waters to being connected to a MWWTP. In 2000, only three of the companies in the study still operated a separate discharge to receiving waters.

The results from earlier projects on introducing cleaner technologies in this sector have been sustained and, in most cases, further increased through the introduction of environmental management programmes (see Section 4.1.1). Some installations have been certified according to ISO 14001, while others have applied non-certified environmental management schemes. In addition, all the installations have employed specialist environmental staff and, in some cases, also a manager.

Achieved environmental benefits

Reduced water consumption. Reduced energy consumption. Reduced pollution of waste water. Waste minimisation, e.g. waste is used as a by-product.

Operational data

In 1989, the water consumption was about 2.5 – 9 m³/t of raw material and the pollution load was about 20 – 120 kg COD/t of raw material. By the year 2000, both water consumption and COD loads had been reduced to about 1.3 – 3.1 m³ water/t raw material and 10 – 24 kg COD/t raw material, respectively. Earlier environmental performance variations among the companies have also been reduced significantly. The remaining difference in environmental performance is mainly due to various levels of product refinement, the different application of abatement technologies and the practising of different types of production planning.

Though the results achieved from implementing the above measures in herring processing are positive and to the benefit of the general environment, it is evident that end-of-pipe treatment still needs to be applied. The pollution level, e.g. measured as COD or nutrients, is still high in the untreated waste water, i.e. between 2000 and 10000 mg COD/l, 200 – 600 mg N/l, and 40 - 100 mg P/l.

Example plants

Five fish processing installations in Denmark.

Reference literature

[147, Lehman N. and Nielsen E.H, 2002]

4.7.2.9.2 Fish processing in the UK

Description

A fish food company produces 12000 t/yr of frozen and chilled fish products at its two sites in Hull, in the UK. Their major products are hot smoked mackerel and herring, cold smoked haddock, white fish fillets, and battered and breaded frozen fish.

In 1996, the company implemented a waste minimisation project which initially focused on water and waste water issues, but soon expanded to cover raw materials, packaging and energy. A waste minimisation team analysed their water use and waste water generation for different processes and prepared water balances for the company's two sites.

Achieved environmental benefits

Reduced water consumption. Improved energy efficiency and hygiene standards.

Operational data

Overall water consumption was reduced by 58 % per tonne of product. The measures to improve performance included:

- using new thawing equipment to eliminate water losses from leakages
- improving the cleaning procedures, e.g. reducing the number of hose pipes and encouraging employees to use plastic shovels and rubber blades to sweep up fish waste (see Section 4.3.1)
- applying dry filleting (see Section 4.7.2.6)
- repairing any leaks (see Section 4.1.5)
- training and raising employees awareness (see Section 4.1.2).

Economics

The benefits of the water consumption and waste water minimisation project included:

- cost savings of over EUR 150000/yr
- payback period of 36 weeks for the new thawing equipment.

Driving force for implementation

In November 1996, the company learnt that its waste water charges would increase significantly in January 2001.

Example plants

A fish processing industry in Hull, UK.

Reference literature

[58, Envirowise (UK), 1999]

4.7.3 Fruit and vegetables

4.7.3.1 Segregation of outputs, to optimise use, re-use, recovery, recycling and disposal (and minimise water use and waste water contamination)

This technique is described in Section 4.1.7.6.

Reported examples of where the technique is applied

There are likely to be many other opportunities to apply this technique within the sector.

- remove fine organic material when, e.g. potatoes are brought into the installation
- restrict sorting, spillage and splash losses by fitting collecting trays, flaps and screens
- use dry separation and collection of solids, semi-solid residues and rejected raw material, e.g. in sorting, trimming, extraction and filtration
- separate solid organic material from the waste water of the peeling process using, e.g. sieves, filters and centrifuges, to restrict leaching
- fit flaps and screens on conveyor belts.

Applicability

Applicable to all fruit and vegetable processing installations.

Reference literature

[31, VITO, et al., 2001]

4.7.3.2 Dry cleaning

This technique is described in Section 4.3.1.

Reported example of where the technique is applied

There are likely to be many other opportunities to apply this technique within the sector.

- clear up spilt vegetables manually as far as possible and avoid rinsing away with water.

Applicability

Applicable to all fruit and vegetable processing installations.

Reference literature

[31, VITO, et al., 2001]

4.7.3.3 Protected outdoor storage of fruit and vegetables

Description

Waste is minimised if fruit and vegetables and organic waste, such as peel and cutting waste are stored in a clear courtyard in the shade and sheltered from rain, or totally enclosed in containers. This minimises contamination and protects the food materials from harm from wet weather conditions.

Achieved environmental benefits

Reduced waste.

Cross-media effects

Storage outside can attract insects, birds and rodents.

Operational data

Some fruit and vegetables may be susceptible to harm from ambient high or low temperatures.

Applicability

Applicable in all installations where raw materials and outputs need to be stored.

Driving force for implementation

Full use of the product and reduced waste.

Reference literature

[31, VITO, et al., 2001]

4.7.3.4 Peeling of fruit and vegetables

Peeling is described in Sections 2.1.1.3 – 2.1.1.3.3. The objective of peeling is to remove the skin/peel from raw fruit and vegetables, by removing as little of the underlying food as possible but still achieving a clean peeled surface. Peeling is applied on an industrial scale to fruit and vegetables. Various methods for peeling exist and are described in the following sections (4.7.3.4.1 – 4.7.3.4.7). The removal of unwanted or inedible material from raw fruit and vegetables, e.g. from leeks and artichokes, is considered to be trimming (see Section 2.1.1.2). Reportedly, the cleaning water from cans and jars can be re-used in peeling.

4.7.3.4.1 Steam peeling – continuous process

Description

The continuous steam peeler is a drum with a screw inside. The steam is fed directly into the drum, generally at a lower pressure than the batch process (see Section 4.7.3.4.2), and the product is heated during an adjustable residence time. Most of the peeled material is discharged with the steam. Any remaining traces are sprayed off with water. This water may be filtered and used to wash raw fruit and vegetables.

If dry brushing is used to remove peel using a brush conveyor instead of water, it is reported that serious bacterial contamination of the brushes and the damage of the fruit or vegetable tissue will inevitably occur.

Achieved environmental benefits

Reduced waste production compared to other peeling techniques, and the peel is often recovered and used as animal feed. Uses less water than a combination of abrasion and knife peeling.

Cross-media effects

Increased steam use compared to both wet and dry caustic peeling. High water consumption and waste water contamination. Odour can also be a problem.

Operational data

Steam peeling uses approximately five times more steam, e.g. for energy, than caustic peeling.

Table 4.85 shows energy carriers and consumption for steam peeling, prior to freezing vegetables.

Energy carrier	Approximate consumption
Hot water (kWh/t frozen vegetables)	0
Steam (t/t frozen vegetables)	0.9
Steam pressure (bar)	7 – 15
Electricity (kWh/t frozen vegetables)	3.5

Table 4.85: Energy carrier and consumption for steam peeling, prior to freezing vegetables

Steam peeling uses large quantities of water, up to five times more than the amount required for caustic peeling, but half of that for a combination of abrasion and knife peeling. It also produces waste water with high levels of product residue. At potato processing installations, the peels can contribute up to 80 % of the total BOD. In fruit processing, peeling waste water can account for as much as 10 % of the total waste water flow and 60 % of the BOD. When steam peeling is applied, cold water may be used to condense the steam. If water cooling is not used then less water is used, less waste is produced and there are lower organic loads in the waste water. Product loss in the peeling process is 8 – 15 %.

The waste consists of the solid peel residues as well as dissolved substances such as starch or tissue fluids. The solid material is generally separated by sedimentation, dried and composted. This fraction contains minerals and bioactive phenolic substances, but also, in the case of potatoes, glycoalkaloids which limit the direct nutritional use.

The steam peeling process in an example installation is shown in Figure 4.50. This can be compared with the outputs if abrasion peeling followed by knife peeling is used, as shown in Figure 4.51.

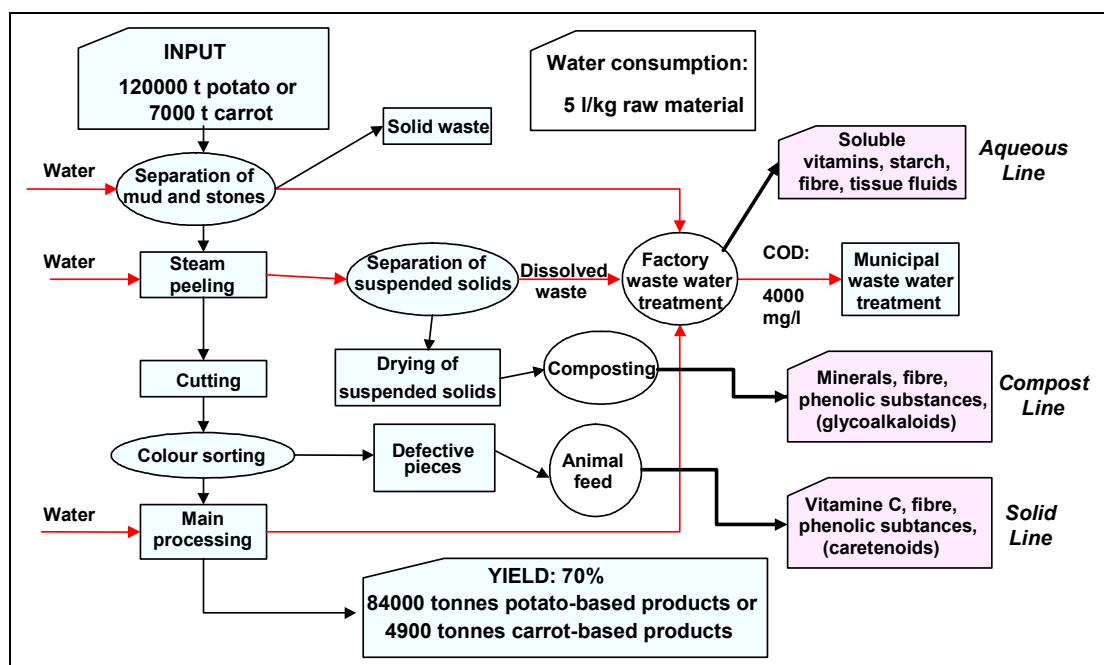

Figure 4.50: Steam peeling process in an example installation in Finland

Applicability

Applicable for all fruit and vegetables which are peeled, except where the peel is relatively hard compared with the fruit flesh, unless it is further processed to make stewed fruit or juice.

Economics

Steam peeling is reported to be more economical than abrasion, knife and caustic peeling.

Example plants

Widely used to peel large quantities of potatoes, sweet potatoes, salsifies, beets, carrots, other tubers and tomatoes.

Reference literature

[31, VITO, et al., 2001, 32, Van Bael J., 1998, 134, AWARENET, 2002, 182, Germany, 2003]

4.7.3.4.2 Steam peeling – batch process

Description

Batch steam peeling is also called “flash steam peeling”. The raw materials such as roots and tubers are exposed to high pressure steam, 1500 to 2000 kPa in a rotating pressure vessel. The high temperature causes a rapid heating and cooking of the surface layer within 15 to 30 seconds. The pressure is then instantly released, which causes the cooked skin to flash off. Most of the peeled material is discharged with the steam and results in a concentrated waste stream. Most of the peeled material is discharged with the steam, and water is only needed to remove any remaining traces.

If dry brushing is used to remove peel using a brush conveyor instead of water, it is reported that serious bacterial contamination of the brushes and the damage of the fruit or vegetable tissue will inevitably occur.

Achieved environmental benefits

Reduced water consumption and waste water production, when compared to continuous steam peeling, but with increased levels of product residue. Reduced waste production compared to other peeling techniques and the peel is often recovered and used as animal feed. A lower waste water pollution load compared to the use of abrasion peeling followed by knife peeling.

Cross-media effects

Higher energy consumption than caustic peeling. Odour can also be a problem.

Operational data

Table 4.85 shows energy carriers and consumption for steam peeling.

The process has lower water consumption and waste water production than continuous steam peeling. With tomatoes, the pressure used ranges from 200 to 350 kPa. This type of peeler is reportedly gaining in popularity due to the lower water consumption, minimum product loss, good appearance of the peeled surfaces and the possible high throughput of up to 4500 kg/h, with automatic control of the peeling cycle.

The waste consists of the solid peel residues as well as dissolved substances such as starch or tissue fluids. The solid material is generally separated by sedimentation, dried and composted. This fraction contains minerals and bioactive phenolic substances, but also, in the case of potatoes, glycoalkaloids which limit the direct nutritional use.

Applicability

Applicable for all fruits and vegetables which are peeled, except where the peel is relatively hard compared with the fruit flesh, unless it is further processed to make stewed fruit or juice.

Economics

Steam peeling is reported to be more economical than abrasion, knife and caustic peeling.

Example plants

Widely used to peel large quantities of potatoes, sweet potatoes, salsifies, beets, carrots, other tubers and tomatoes.

Reference literature

[31, VITO, et al., 2001, 32, Van Bael J., 1998, 134, AWARENET, 2002, 182, Germany, 2003]

4.7.3.4.3 Abrasion peeling

Description

In abrasion peeling, the material to be peeled is fed onto carborundum rollers or fed into a rotating bowl, which is lined with carborundum. The abrasive carborundum surface removes the skin, which is then washed away with a copious supply of water. The process is normally carried out at ambient temperature.

Achieved environmental benefits

The peel can be recovered and used as animal feed. Reduced energy consumption.

Cross-media effects

Large quantities of water are consumed. There is high product loss and high production of waste water. Odour emissions can be a problem. A combination of abrasion peeling and knife peeling produces a higher waste water pollution load than steam peeling.

Operational data

This technique has significantly higher product loss than steam peeling, i.e. a 25 % loss compared to 8 – 15 % loss. If the vegetables are sorted and peeled in uniform sizes, the proportion of flesh removed as peeling waste may be reduced. There is also considerably more waste water produced than from steam peeling. This dilute waste water contains the high product loss and it is expensive and difficult to treat.

Energy is not required for heating water or producing steam, but is needed for the operation of the rollers or rotating bowl.

The relatively low throughputs are due to all of the pieces of food needing to contact the abrasive surfaces. The hygiene quality is sometimes a problem because, as no peeling water is added, the cooling function of water is not fulfilled, and there can be localised high temperatures. Nevertheless, the quality of potatoes can reportedly be maintained during peeling using carborundum.

Applicability

This technique is used for peeling onions, potatoes, carrots and beets, as the skin is easily removed and the quality of the product can be maintained. Sometimes abrasion peeling is used as a pre-peeling step before knife peeling (see Table 4.86).

Economics

The capital and energy costs are low. Steam peeling is reported to be more economical.

Example plants

Widely applied for peeling potatoes and onions.

Reference literature

[1, CIAA, 2002, 31, VITO, et al., 2001, 182, Germany, 2003, 200, CIAA, 2003, 208, CIAA-AAC-UFE, 2003, 232, Fellows P J,]

4.7.3.4.4 Knife peelingDescription

In knife peeling, the material to be peeled is pressed to against rotating blades, or is itself rotated against stationary blades. Although water is not used during the actual peeling operation, it is used for the continuous cleaning of rollers and blades, so contaminated waste water is produced.

Achieved environmental benefits

The peel can be recovered and used directly as animal feed or for recovery of its components. Less energy consumption than steam peeling.

Cross-media effects

Odour emissions and noise pollution. A combination of abrasion peeling and knife peeling produces a higher waste water pollution load than steam peeling and uses twice as much water.

Operational data

The product loss after knife peeling is 16 – 17 %. Maintaining the knife sharp reduces damage to the product and consequent waste. After cutting, defective pieces, e.g. which are too dark or too small, can be separated and used as animal feed. In carrot processing, several valuable substances such as vitamin C, fibre, phenolic compounds and carotenoids, can be recovered as by-products.

Table 4.86 shows the effect of a combination of abrasion pre-peeling and knife peeling on water pollution in the production of half pears in syrup.

	BOD (kg/t)	COD (kg/t)	SS (kg/t)
Abrasion pre-peeling plus knife peeling	21.6	36.5	21.5
Water consumption if the water is not re-used for cooling cans after sterilisation	29.6 m ³ /t		
Water consumption if the water is re-used for cooling cans after sterilisation	6.2 m ³ /t		

Table 4.86: The effect of a combination of abrasion pre-peeling and knife peeling on water pollution loads in the production of half pears in syrup

Figure 4.51 shows a flow diagram of potato and carrot processing showing the outputs if abrasion peeling followed by knife peeling is used. This can be compared to the outputs if steam peeling is used, as shown in Figure 4.50.

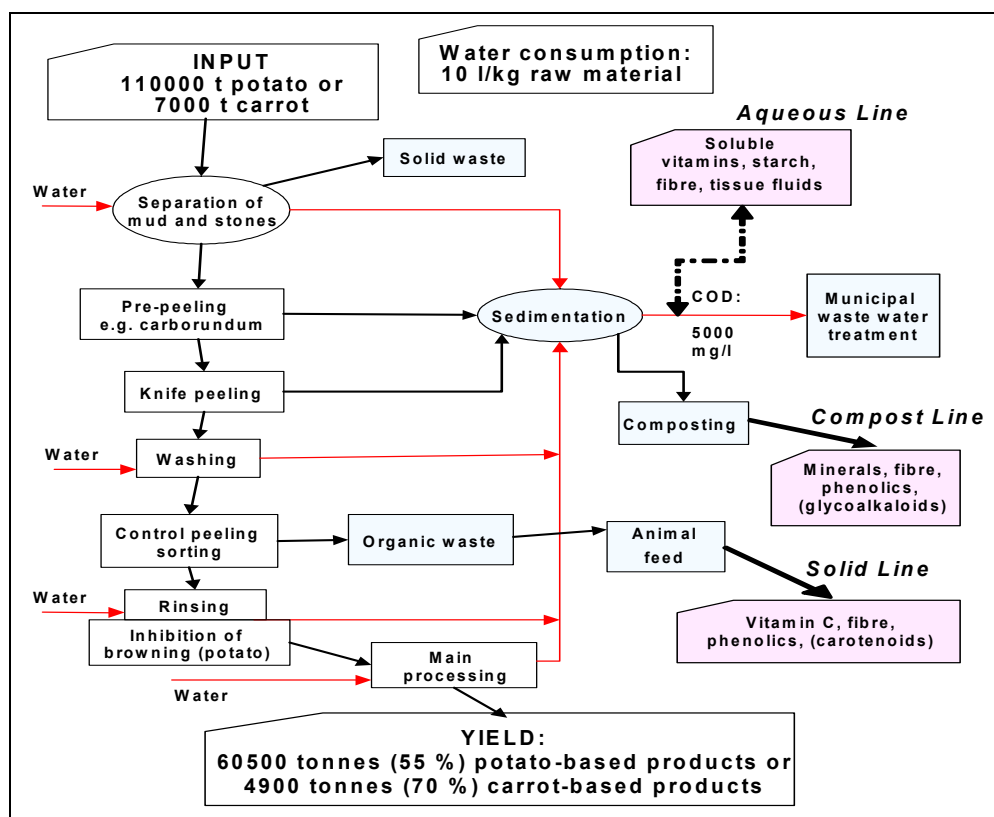

Figure 4.51: Flow diagram of potato and carrot processing in a Finnish installation

Applicability

Knife peeling is particularly used for citrus fruits where the skin is easily removed and little damage is caused to the fruits and for small quantities of, e.g. potatoes, carrots, beets and apples, or when vegetables are used for catering or in institutional kitchens. Peaches and pears can be peeled using very small blades mounted on rollers.

Economics

Knife peeling is reportedly more expensive than steam peeling.

Reference literature

[1, CIAA, 2002, 31, VITO, et al., 2001, 124, Italy, 2002, 134, AWARENET, 2002, 182, Germany, 2003, 200, CIAA, 2003, 208, CIAA-AAC-UFE, 2003]

4.7.3.4.5 Wet caustic peeling

Description

The material to be peeled is either placed in or passed through a dilute solution, e.g. 1 to 2 %, but as high as 20 %, of caustic, heated to 80 – 120 °C. This softens the skin which can then be sprayed off by high pressure water sprays. The caustic concentration and the temperature depend on the type of fruit or vegetable and the degree of peeling required. Although water is not used during the actual peeling operation, it is used for the continuous cleaning of rollers and blades, so contaminated waste water is produced.

Achieved environmental benefits

Reduced water and energy consumption compared to steam peeling.

Cross-media effects

Waste water with high pH and organic load produced. Highly alkaline or salty solid waste is produced, which is difficult to dispose of. The use of chemicals may limit the use of the nutrients the peel contains. If the peel is used for nutrition, separate waste water treatment is needed. Odour is emitted and there is noise pollution. The product can become decolourised.

Operational data

The use of caustic peeling may cause pH fluctuations in the waste water. Furthermore, caustic peeling causes higher solubilisation of material and consequently high COD, BOD and SS loads. The BOD and COD levels are higher than for abrasion peeling followed by knife peeling, but the SS load is lower. Caustic peeling needs less energy, both in terms of electricity consumption and steam consumption, than steam peeling, but creates a greater load for the WWTP. Wet caustic peeling uses four times less water than steam peeling. Some products, e.g. tomatoes, require strong caustic solutions and the addition of wetting agents. In the case of gherkins, the concentration of the caustic is approximately 2 %, in the case of carrots approximately 10 % and in the case of pumpkins up to 20 %. Product loss is around 17 %.

Table 4.87 shows the effect of caustic peeling on water pollution in the production of half pears in syrup. This can be compared with the same operation using abrasion peeling followed by knife peeling in Table 4.86. Table 4.88 shows energy carriers and consumption data for caustic peeling, prior to freezing vegetables.

	BOD (kg/t)	COD (kg/t)	SS (kg/t)
Caustic peeling	39.7	66.3	11.4
Water consumption if the water is not re-used for cooling cans after sterilisation	29.6 m ³ /t		
Water consumption if the water is re-used for cooling cans after sterilisation	6.2 m ³ /t		

Table 4.87: The effect of caustic peeling on water pollution in the production of half pears in syrup

Energy carrier	Approximate consumption
Hot water (kWh/t frozen vegetables)	0
Steam (t/t frozen vegetables)	0.16
Steam pressure (bar)	7
Electricity (kWh/t frozen vegetables)	2

Table 4.88: Energy carriers and consumption for caustic peeling, prior to freezing vegetables

At an example installation, water use and the resulting waste water were compared for wet and dry caustic peeling (see Section 4.7.3.4.6) at a site processing 72 t/d of table beet. For the same quantity of product processed, dry caustic peeling reduced water use by 75 % and solid waste by 90 % compared to wet caustic peeling. In addition, the waste water generated during dry caustic peeling contained 88 % less SS, 94 % less COD and 93 % less BOD than that from wet caustic peeling. Nevertheless, it is reported that the peel contaminated with caustic is, at least in some cases, disposed of to the WWTP in small amounts, after buffering. Dry caustic peeling tends to have a lower caustic consumption than wet methods.

Applicability

Applicable for all fruit and vegetables which are peeled. It can be used where the peel is relatively hard compared with the fruit flesh and where steam peeling cannot be applied.

Economics

Wet caustic peeling produces waste with a very high pH and organic loading, which then adds to the water treatment costs. Caustic peeling is reportedly more expensive than steam peeling.

Example plants

Used for peeling potatoes, carrots, beets, salsifies, peaches, apricots, apples, pears, tomatoes, peppers, pumpkins, gherkins and citrus fruits. It is reportedly used for peeling apples because steam peeling (see Section 4.7.3.4.1) damages the fruit's flesh.

Reference literature

[1, CIAA, 2002, 13, Environment Agency of England and Wales, 2000, 31, VITO, et al., 2001, 32, Van Bael J., 1998, 45, Envirowise (UK) and Ashact, 2001, 124, Italy, 2002, 182, Germany, 2003, 200, CIAA, 2003, 208, CIAA-AAC-UFE, 2003]

4.7.3.4.6 Dry caustic peeling

Description

In dry caustic peeling, the material is dipped in a 10 % caustic solution heated to 80 – 120 °C, to soften the skin, which is then removed by rubber discs or rollers. This reduces water consumption and produces a concentrated caustic paste for disposal. Peeling is followed by washing to remove the peel and any residual caustic.

In the case of peeling peaches and apricots, the skin is very fine and soft and not as easily distinguishable from the fruit flesh as that of e.g. tomatoes, peppers and potatoes, so it “clings” to the flesh. The skin clings to the flesh of less ripe fruit more strongly than it clings to ripe fruit. Peaches and apricots are immersed into the caustic solution and the skin is decomposed. The residue is then removed by spraying the fruit with water. In practice, fruits of varying ripeness are peeled together and the process is prolonged to ensure that the least ripe fruit are peeled. In the case of e.g. peeling peaches and apricots for subsequent preservation either whole or in halves, the mechanical removal of the softened skin would cause unacceptable damage to the surface of the fruit.

Achieved environmental benefits

Reduced water consumption compared to steam peeling and wet caustic peeling. Reduced solid waste and waste water production compared to wet caustic peeling. Lower caustic consumption than wet caustic peeling. Reduced energy consumption compared to steam peeling.

Cross-media effects

Highly alkaline or salty solid waste is produced. The use of chemicals may restrict the nutritional exploitation of the separated peel mass. Odour is emitted. Noise pollution can also be a problem. The product can become decolourised.

Operational data

Dry caustic peeling methods can greatly reduce the volume and strength of the waste water compared to steam peeling and wet caustic peeling. The peel can be collected as a pumpable slurry, which needs to be disposed of. It is reported that the peel contaminated with caustic is, at least in some cases, disposed of to the WWTP in small amounts, after buffering. Dry caustic peeling tends to have a lower caustic consumption than wet caustic peeling (see Section 4.7.3.4.5).

At an example installation, water use and the resulting waste water were compared for wet and dry caustic peeling at a site processing 72 t/d of table beet. For the same quantity of product processed, dry caustic peeling reduced water use by 75 % and solid waste by 90 % compared to wet caustic peeling. In addition, the waste water generated during dry caustic peeling contained 88 % less SS, 94 % less COD and 93 % less BOD than that from wet caustic peeling.

Applicability

Applicable for all fruits and vegetables which are peeled. It can be used where the peel is relatively hard compared with the fruit flesh and steam peeling cannot be applied.

Economics

Dry caustic peeling produces waste with a very high pH, which adds to the water treatment costs. Dry caustic peeling is reportedly more expensive than steam peeling.

Example plants

Used for the peeling of potatoes, carrots, salsifies, apples, peaches and apricots.

Reference literature

[1, CIAA, 2002, 31, VITO, et al., 2001, 32, Van Bael J., 1998, 45, Envirowise (UK) and Ashact, 2001, 124, Italy, 2002, 182, Germany, 2003, 208, CIAA-AAC-UFE, 2003, 258, Federación Nacional de Asociaciones de la Industria de Conservas Vegetales, 2005]

4.7.3.4.7 Flame peelingDescription

This technique was developed for onions. A flame peeler consists of a conveyer belt which transports and rotates the material through a furnace heated to temperatures above 1000 °C. The skin or root hairs are burned off and then removed by high pressure water sprays.

Achieved environmental benefits

Flame peeling requires heat, in contrast to other peeling operations which require electrical energy.

Cross-media effects

When flame peeling is applied, some dust and odour emissions occur.

Operational data

Average product losses are 9 %. It is reported that red peppers used for the Spanish recipe “piquillo peppers” can only be peeled using flame peeling.

Applicability

Flame peeling is used for peeling onions and peppers.

Reference literature

[134, AWARENET, 2002]

4.7.3.5 Blanching of fruit and vegetables

Blanching is described in Section 2.1.5.2. It generally comprises three steps, i.e. preheating, blanching and cooling and is followed by further processing such as the manufacture of preserves or freezing. Table 4.89 shows a qualitative comparison of energy and water consumption levels within the different blanching techniques.

Blanching technique	Energy	Water
Steam blanching with air cooling	3	1
Belt blanching with water cooling	1	3
Belt blanching with air cooling	4	2
Drum blanching with countercurrent water cooling	2	4
1: Lowest consumption 4: Highest consumption		

Table 4.89: Comparison of the energy and water consumption levels within the different blanching techniques

4.7.3.5.1 Steam blanching with air cooling

Description

Steam blanching is a continuous process where the food is moved on one long perforated conveyor belt. During preheating, the food is sprinkled with water from above and sprayed by water from below. The preheating water is maintained at 60 °C using steam.

During the blanching step, the food is further heated by direct steam injection from below. To minimise water and energy consumption, the steam is recycled and the process takes place in sealed equipment, designed to minimise steam consumption.

Finally, the food is cooled with air using heavy duty fans. The air is cooled further, to a lower temperature, by spraying water into the airflow. This water prevents the food from drying. If necessary, the food can be further cooled down with water in the last cooling compartment. Re-using this cooling water in the preheating section is not useful, as the water does not hold much energy. Air cooling is less energy efficient than water cooling as the heat cannot be re-used and the fans for blowing the air across the food have high energy consumption.

Achieved environmental benefits

Lowest water consumption and waste water volume, compared to the other blanching techniques. Reduced energy consumption compared to belt blanching with air cooling.

Cross-media effects

Higher energy consumption than the belt blancher with water cooling and the drum blancher with countercurrent water cooling. High BOD load in the waste water.

Operational data

The optimal temperature and time of blanching depend on the type of food and the size of the pieces being blanched. Typical blanching conditions are 65 to 95 °C, for one minute or more. Steam blanching produces waste water with high BOD levels.

The energy efficiency can depend on the method of retaining the steam pressure. Food can enter and leave the blancher through rotary valves and seals to reduce steam losses and increase energy efficiency, or steam can be re-used by passing it through venturi valves. Using a combination of hydrostatic and venturi valves can improve the efficiency further.

Steam blanchers reportedly lead to smaller losses of water soluble components and nutrients, but blanching can be uneven if the food is piled too high on the conveyor or if spots of the product have touched each other they may not be blanched.

Applicability

Applicable for blanching fruit and vegetables.

Reference literature

[1, CIAA, 2002, 31, VITO, et al., 2001, 87, Ullmann, 2001]

4.7.3.5.2 Belt blanching with water cooling

Description

This is a continuous process where the food is moved on one long perforated conveyor belt. The food is preheated with water sprinkled from above and sprayed from below, flowing countercurrently with the food. The temperature of the preheating water is maintained at 60 °C using steam. The cooled preheating water can be re-used in other processes, e.g. washing and cutting and pre-rinsing of, e.g. freezing tunnels.

In the blanching section, the food is also sprinkled with water from above and sprayed by water from below. For this step the water temperature is maintained at, e.g. 80 – 95 °C, by steam injection.

Finally, the food is cooled with water. Cooling is undertaken in a series of different compartments. In each compartment, water is sprayed over and under the food. Fresh cooling water at, e.g. 2 – 15 °C, enters the last compartment of the cooling section and is re-used in the preceding compartments. The water from the first compartment of the cooling section, i.e. immediately after blanching, which is warm, is re-used in the preheating section, leading to heat recovery and a reduction in water consumption. If the coldest water available is used for cooling, this also reduces the energy consumption, for both the cooling step after blanching and if the food is destined for low temperature storage or processing, e.g. freezing.

Achieved environmental benefits

Lowest energy consumption compared to all the other blanching techniques. Reduced water consumption compared to the drum blancher with countercurrent water cooling.

Cross-media effects

Higher water consumption compared to steam blanching with air cooling and belt blanching with air cooling. High BOD load in the waste water.

Operational data

The optimal temperature and time of blanching depend on the kind and size of food. Hot water blanching produces waste water with high BOD levels.

If a belt blancher is combined with water cooling, 2 – 8 kWh_c/t frozen product are consumed. Belt blanching with water cooling is the most energy efficient blanching technique. The reason is that the heat released by the cooling of the food in the cooling zone is used to preheat the vegetables before blanching. Also, the water consumption is minimised by re-using it within the cooling compartments and for preheating.

Table 4.90 shows the energy carriers and consumption for the belt blancher with water cooling expressed in terms of the amount of frozen product, i.e. assuming the product will be frozen after blanching.

Energy carrier	Approximate consumption
Hot water (kWh/t frozen vegetables)	0*
Steam (t/t frozen vegetables)	0.09
Steam pressure (bar)	7
Electricity (kWh _c /t frozen vegetables)	2 – 9
*Hot water is 0 because water is heated by steam injection	

Table 4.90: Energy carriers and consumption for a belt blancher with water cooling

Applicability

Applicable for blanching fruit and vegetables.

Reference literature

[31, VITO, et al., 2001, 32, Van Bael J., 1998]

4.7.3.5.3 Belt blanching with air cooling

Description

This is a continuous process where the food is moved along on one long perforated conveyor belt. The food is preheated with water sprinkled from above and sprayed from below, flowing countercurrently with the food. The preheating water is maintained at 60 °C using steam. The cooled preheating water can be re-used in other processes, e.g. washing and cutting processes and pre-rinsing of, e.g. freezing tunnels.

In the blanching section, the food is sprinkled with water from above and sprayed by water from below. The water temperature is maintained at, e.g. 80 – 95 °C, by steam injection.

The blanched food is cooled with air using heavy duty fans. The air is cooled further, to a lower temperature, by spraying water into the airflow. This water prevents the food from drying. If necessary, the food can be further cooled down with water in the last cooling compartment. Re-using this cooling water in the preheating section is not useful, as the water does not hold much energy. This technique is less energy efficient, because with air cooling the heat cannot be re-used and the fans for blowing the air across the food have high energy consumption.

Achieved environmental benefits

Reduced water consumption compared to belt blanching with water cooling and drum blanching with countercurrent water cooling.

Cross-media effects

Highest energy consumption compared to the other blanching techniques. Higher water consumption than steam blanching with air cooling. High BOD load in the waste water.

Operational data

The optimal temperature and time of blanching depend on the kind and size of food. Hot water blanching produces waste water with high BOD levels.

When a belt blancher is used combined with air cooling, 7 – 28 kWh_e/t frozen product are consumed. Heavy duty fans consume 60 kWh_e. Table 4.91 shows the energy carriers and consumption for the belt blancher with air cooling, expressed in terms of the amount of frozen product.

Energy carrier	Order of magnitude indicators
Hot water (kWh/t frozen vegetables)	0*
Steam (t/t frozen vegetables)	0.16
Steam pressure (bar)	7
Electricity (kWh _e /t frozen vegetables)	7 – 30
*Hot water is 0 because water is heated by steam injection	

Table 4.91: Energy carriers and consumption for a belt blancher with air cooling

When processing preserves, cooling of the food to about 40 °C is sufficient, because it is subject to further processing involving heat which prevents the development of bacteriological problems. Preserves undergo heat treatment at a later stage, e.g. during sterilisation and pasteurisation. This means that less energy is used when applying this technique for preserves, compared to other uses of the fruit and vegetables sector which would need to be cooled further, e.g. prior to freezing.

Applicability

Applicable for blanching fruit and vegetables.

Reference literature

[31, VITO, et al., 2001, 32, Van Bael J., 1998]

4.7.3.5.4 Drum blancher with countercurrent water cooling

Description

This is a batch process where the food enters the system via a trough and a rotating screw. The water for the blancher is heated by steam injection. The food leaves the system via a perforated paddle. Next, the product is cooled using water running countercurrently to the food. The heated cooling water can be re-used in other processes, e.g. to simultaneously preheat the fresh food and transport it to the drum blancher.

Achieved environmental benefits

Lower energy consumption compared to belt blanching with air cooling and steam blanching with air cooling.

Cross-media effects

Highest water consumption compared to the other blanching techniques. High BOD load in the waste water. Higher energy consumption than belt blanching with water cooling.

Operational data

The optimal temperature and time of blanching depend on the kind and size of the food. The drum blancher with countercurrent water cooling consumes 1 – 2.6 kWh_e/t frozen product. The countercurrent drum cooler consumes 2 – 4 litres of water per kilogram of food.

Table 4.92 shows the energy carriers and consumption for drum blanching, expressed in terms of the amount of frozen product, assuming that the food will be frozen.

Energy carrier	Approximate consumption
Hot water (kWh/t frozen vegetables)	0*
Steam (t/t frozen vegetables)	0.16
Steam pressure (bar)	7
Electricity (kWh _e /t frozen vegetables)	0.5 – 1.3
*Hot water is 0 because water is heated by steam injection	

Table 4.92: Energy carriers and order of magnitude indicators of the drum blancher

Table 4.93 shows the energy carriers and consumption for countercurrent drum water cooling, expressed in terms of the amount of frozen product, assuming that the food will be frozen.

Energy carrier	Approximate consumption
Hot water (kWh/t frozen vegetables)	0
Steam (t/t frozen vegetables)	0
Steam pressure (bar)	0
Electricity (kWh _e /t frozen vegetables)	0.5 – 1.3

Table 4.93: Energy carriers and consumption for countercurrent drum water cooling

Applicability

Applicable for blanching fruit and vegetables.

Reference literature

[31, VITO, et al., 2001, 32, Van Bael J., 1998, 232, Fellows P J,]

4.7.3.6 Cooling fruit and vegetables before freezing

Description

The temperature of fruit and vegetables as they enter the freezing tunnel is an important factor that also determines the energy consumption of the system. The lower the temperature, the lower the cooling load and the lower the energy consumption. The temperature of the fruit and vegetables can be lowered by bringing them into contact with sufficiently cold water for a sufficient time. This is generally the cooling step after blanching. If the ambient temperature of the water is above 4 °C, an ice-water trough can be used to cool the fruit and/or vegetables to 4 °C. Additionally, the circulating water in the ice-water trough can be continually cooled by fitting an additional water cooler in the ice-water trough (see Figure 4.52) or by placing an evaporator plate under the ice-water trough (see Figure 4.53). This evaporator plate is connected into the freezer system in a similar way as the heat-exchanger for ice-water production. If the water is carried into the freezing tunnel it becomes frozen and adds an additional energy burden. This can be prevented by passing the food over a vibrating mesh or perforated belt which enables the water to be removed from the food and then collected for re-use in the cooling process.

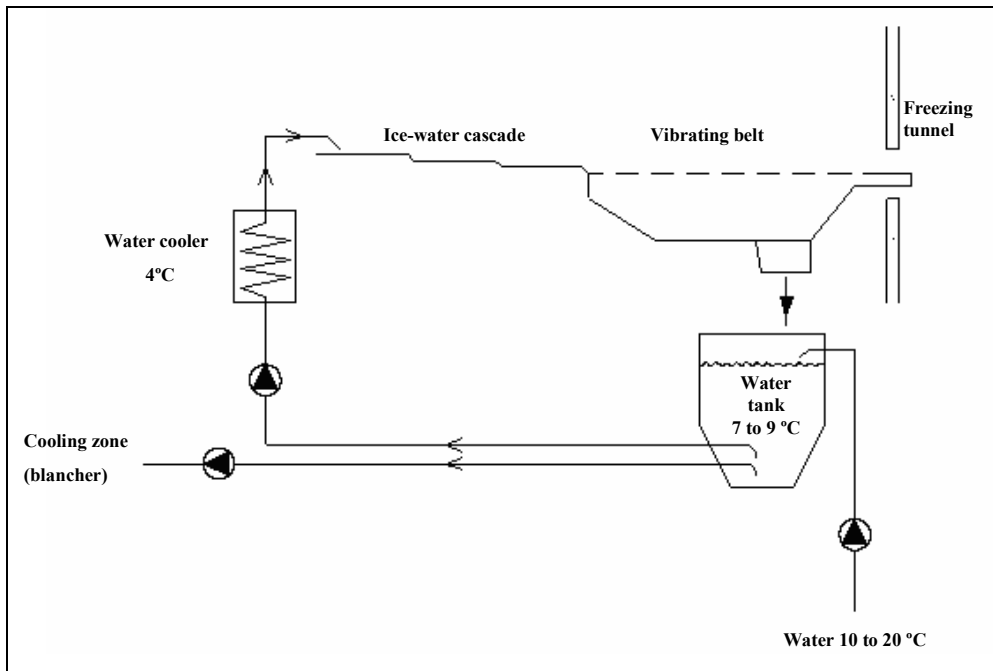

Figure 4.52: Installation of a water cooler in the ice-water trough

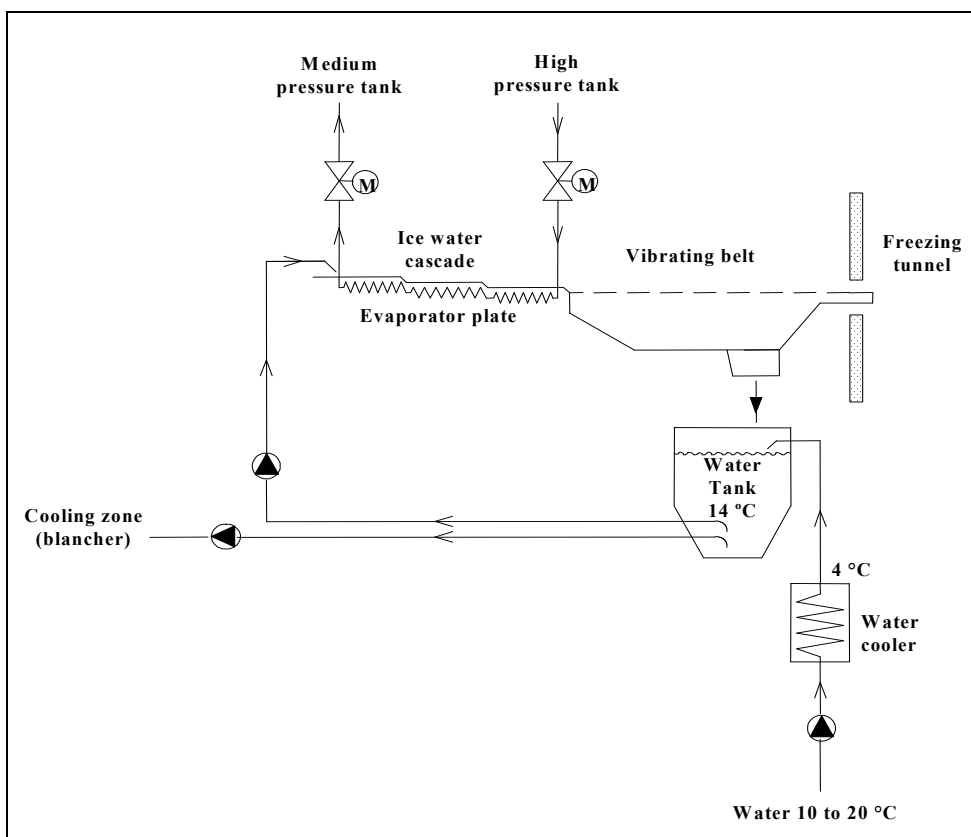

Figure 4.53: Installation of an evaporator plate under the ice-water trough

Achieved environmental benefits

Reduced energy consumption in the freezing process.

Cross-media effects

Energy consumption in the cooling process before freezing.

Operational data

It is reported that a reduction of the product temperature by 10 °C results in:

- a reduction of the compressor load for cooling at -30 to -40 °C, which reduces electricity consumption by 5 to 7 kWh_e/t
- an increase in the compressor load for cooling at 0 °C, which reduces electricity consumption by 1.5 to 2 kWh_e/t
- a total reduction of the electrical load by 3 to 5.5 kWh_e/t.

It is also reported that, when a freezing tunnel is operating at a product flowrate of 10 t/h, then the electrical load will fall by 30 to 55 kW if the fruit or vegetable temperature is reduced from 30 to 20 °C before entering the freezing tunnel. Furthermore, the heat transfer when the cooling is carried out with water is an order of magnitude higher than when the cooling is carried out with air. In addition, fruit and vegetables are best transported as cold and dry as possible in the freezing tunnel, in order to reduce the freezing load, and this is facilitated by draining the fruit or vegetables after immersion in the cold water.

Applicability

Applied in the deep freezing of fruit and vegetables.

Reference literature

[31, VITO, et al., 2001, 32, Van Bael J., 1998]

4.7.3.7 Re-use of water in fruit and vegetable processing

Description

In new and existing installations opportunities may exist for the re-use of water, either directly in a unit operation or indirectly as a source, e.g. either heat or cold. In existing installations in particular, such opportunities vary depending, e.g. on the unit operations undertaken, the waste water treatment facilities available on the site and the hygiene requirements for the water used on the site. It may be possible to re-use water in the same unit operation either without any treatment, or after a simple filtration.

A systematic analysis, like that described in Section 4.1.6.4.1, taking into account all water uses and the quality required for each use and re-use can be undertaken. An example of a table for recording such opportunities is shown in Table 4.94.

EXAMPLES						
			A	B	C	D
E X A M P L E S		Water re-use applications	Process techniques which do not require full WWT (specify any treatment which may be necessary first, e.g. screening or disinfection)		Cleaning (possibly differentiate between different cleaning stages)	All unit operations which require drinking water quality water.
		Water use				
	1					
	2					
	3					
	4				After filtering to remove pieces of vegetables	
	5					
	6	Indirect cooling (no contact with the product)				
	7					
8						

Table 4.94: Examples of water re-use in the fruit and vegetable sector

Achieved environmental benefits

Reduced water consumption and, where heated water is re-used, reduced energy consumption.

Cross-media effects

If treatment is required before re-use, energy is consumed and chemicals may also be consumed.

Operational data

In the fruit and vegetable sector, the segregation of rainwater, wash-water, e.g. water that arises from washing raw materials and from cleaning operations, and process water, e.g. water that arises from peeling, sorting and canning, has been reported. Furthermore, water that has only been used for washing incoming products and has low levels of BOD can be just screened rather than undergoing full treatment. The same applies to freezer defrost water.

For example, in belt blanching with water cooling the water from the first compartment of the cooling section, i.e. immediately after blanching, which is warm, is re-used in the preheating section before blanching. In this example, heat is recovered and less water is used due to the recirculation. It is also reported that for some fruit and vegetables blanching water can be used for preliminary cleaning of freezing tunnels.

Water used for blanching and water used for cooling after blanching can be used for washing raw materials, without treatment.

Water used for boiling fruit and vegetables can also be used for washing raw materials, without treatment.

It is reported that water from cooling cans and jars in fruit and vegetable preservation can be re-used for cooling water after sterilisation of the cans and jars, for washing raw materials, for washing peeled fruit and vegetables, to heat cold water for use in blanching or as cleaning water.

It is also reported that water from sterilisation processes can be used to prewash raw materials. If this water is heated it may affect the shelf-life of the food, by encouraging bacterial growth. Re-use of heated water for washing may depend on whether the fruit and vegetables are subjected to heat treatment later.

After biological waste water treatment and chlorination, water can be re-used for cleaning floors.

After biological treatment, RO and UV disinfection water can be used for uses which require drinking water standards. A reported example describes water being re-used to wash salads (see Section 4.5.7.3.4).

Applicability

Applicable in new and existing installations. Improving water re-use in existing installations, using equipment that will later be replaced with BAT, may be able to re-use water to minimise the environmental impact of the existing equipment.

Driving force for implementation

Reduced water consumption and, in some cases, reduced energy consumption.

Reference literature

[31, VITO, et al., 2001, 200, CIAA, 2003]

4.7.4 Vegetable oils and fats

4.7.4.1 Two-phase extraction of olive oil

Description

Olive oil production has traditionally been one of the major sources of industrial pollution in the regions where it is carried out, e.g. in Andalusia, Spain. In traditional olive processing, i.e. the three-phase production, the extraction of the olive seeds has resulted in three streams, i.e. oily, aqueous and solid.

The oily stream is the virgin oil. It is produced at a rate of about 200 kg/t of olives if obtained using continuous separation by decanter centrifuges, or 150 kg/t using olive presses.

The aqueous waste, i.e. waste water, is sometimes called “vegetable water” and is highly polluted. Its volume depends on the technique applied but, in general, 1 m³ of waste water is produced per tonne of olives processed. The specific pollution is estimated to be about 65 kg BOD₅/t olives processed. In the beginning of the 1990s, the resultant waste water during a 100 days campaign represented about the same amount of water as Andalusia’s total population for the whole year. At that time, only the classical presses and the three-phase continuous separation by decanter centrifuges were used.

The solid waste consists of two major parts, i.e. the stones or kernels and the crude oil cake/pomace. The stones accumulate in installations where destoned or stuffed table olives are produced. They can be used as fuel for heating, building materials or for activated charcoal. There is still a small amount of oil in the olive cake from the first pressing of the olives and this can be extracted. Its water content and composition depend on the extraction technique applied. If not going on for further processing, i.e. extraction, this cake is often used as fuel for heating, for animal feed supplement or returned to the olive grove as a mulch to condition the soil.

In a new technique implemented first in 1991 – 1992, the decanter centrifuges are modified so that the crushed (mixed) olives are separated into two-phases, i.e. the oil phase and a solid phase. This technique does not require the addition of water to the olive mixture. By 2000, virtually all of the Andalusian olive oil mills had converted to the two-phase process.

The degree of application of the two-phase and three-phase olive oil processes, in Andalusia, are compared in Figure 4.54.

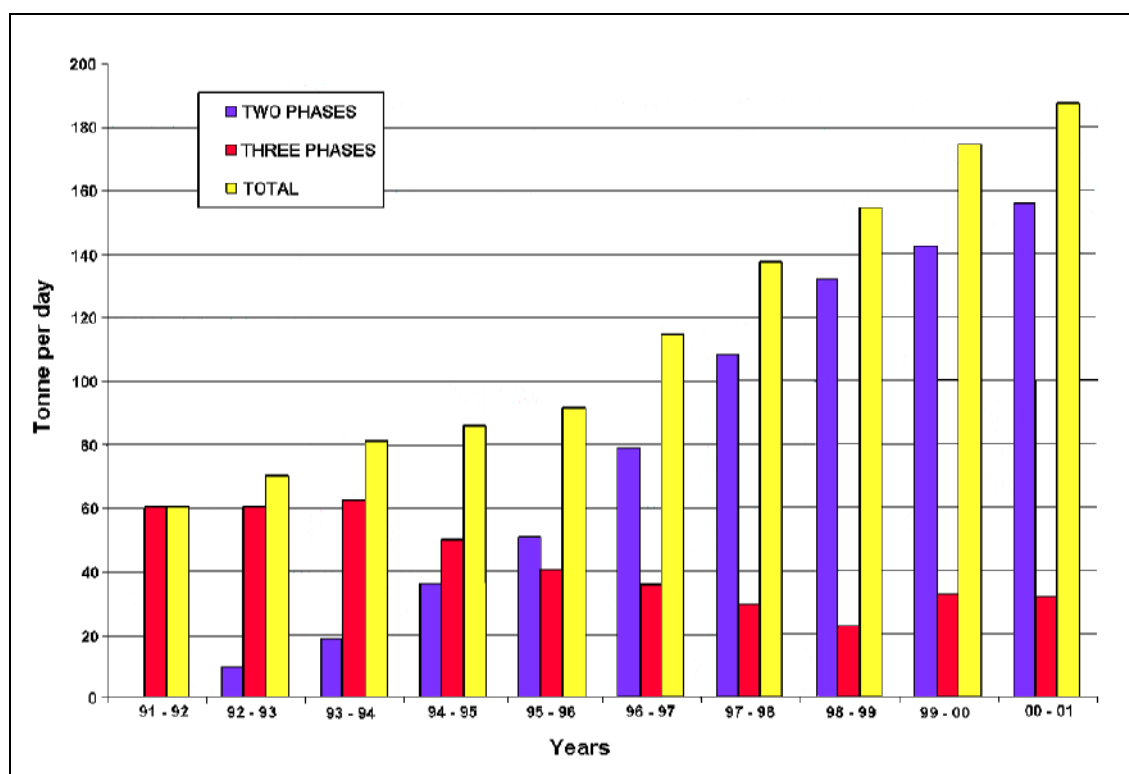

Figure 4.54: The two-phase and three-phase olive oil extraction processes [86, Junta de Andalucia and Agencia de Medio Ambiente, 1994]

Achieved environmental benefits

Water is saved in the extraction part of the two-phase process. The amount of waste water and its contaminant load are also reduced. The water savings are particularly significant because olives are grown and processed in areas of very low rainfall. The rural settings of a significant proportion of the industry also means that there is little access to MWWTPs. The wetter solid output is considered less of a problem than the waste water produced from the three-phase process.

Cross-media effects

The solid output, i.e. cake or pomace (in Spanish “alpeorujo”) is produced in greater amounts than from the three-phase process and contains 7–21 % more water. After further hexane extraction, the so-called exhausted olive cake is generated. This is often used as fuel for heating, for animal feed supplement or returned to the olive grove as a mulch. The exhausted olive cake is normally dried before disposal. The energy requirement and the cost of the drying is higher and the drying is more difficult due to the higher water, polysaccharides, and polyphenols content of the “alpeorujo”.

Operational data

No water is used in the extraction part of the two-phase process and, in consequence, there is no need to treat it. The energy savings are about 20 %. The amount and the pollution load of the waste water is less. In the traditional process, the processing of 1 tonne of olives resulted in the production of about 1 m³ of waste water with an average BOD₅ level of 60000 mg/l. The amount of waste water produced using the two-phase technique is about 0.3 m³/tonne olives, with an average BOD₅ of 20000 mg/l, i.e. the pollution load is about 1/10. As no water is used in the extraction, there are also savings in water consumption.

There are difficulties associated with the handling of the olive cake, which has a higher moisture content than the traditional cake and is not accepted by traditional extraction installations. It is also reportedly less profitable to extract the oil from it, due to its lower oil content, compared to the traditional or three-phase systems. Composting is reported to be an option in all cases. Use as biomass fuel is reported to be an option if a critical mass of olive cake is available, so not in cases of individual dispersed and isolated installations.

The throughputs of the two-phase and three-phase olive oil processes are compared in Table 4.95.

		Two-phase process		Three-phase process	
		IMPEL project data	Spanish data	IMPEL project data	Spanish data
Input	Olives (t)	1	1	1	1
	Water (t or m ³)	0	0	0.5	0.7 – 1
Output	Oil (t)	0.18	0.2	0.18	0.2
	Waste water (t or m ³)	0	0	0.72	1 – 1.2
	Pomace (t)	0.82	0.8	0.60	0.5 – 0.6
	Organic pollutants (per tonne of olive oil produced)	1.5 (as pomace)	27 (as waste water and pomace)	1.5 (as waste water and pomace)	27 (as pomace)

Table 4.95: Comparison of throughputs for the three-phase and two-phase olive oil processes

In two-phase extraction of olive oil it is not necessary to add hot water. The energy consumption for both systems is reported to be <90 – 117 kWh/t. Also, both systems use the same volume of washing water, i.e. 0.08 – 0.3 m³/t olives. This water consumption is independent of the extraction process, although, in some cases, it gets mixed with the waste water or wet pomace from the extraction process. Some mills do not use washing water as they collect the olives directly from the trees.

In Spain, the overall reported yields for two-phase and three-phase extraction of olive oil, for the 2004 – 2005 campaign, are 20.68 and 20.29 % respectively.

Applicability

Existing three-phase decanter centrifuges can be modified to two-phase operation. Pomace driers originally used after three-phase extraction are unsuitable for drying the pomace produced using the two-phase technique. Compare to the pomace produced by the three-phase extraction technique, the pomace produced using the two-phase technique contains both much more moisture and organic pollutants. If the two-phase pomace is not dried under suitable conditions, the oil produced from it can contain PAH levels which exceed those allowed under food safety legislation (COMMISSION REGULATION (EC) No 208/2005 of 4 February 2005 amending Regulation (EC) No 466/2001 as regards polycyclic aromatic hydrocarbons (text with EEA relevance)).

Economics

Savings in water, energy and waste water treatment costs are achieved. The decanter centrifuges for the two-phase separation are about the same price as the decanter centrifuges for three-phase separation. The cake/pomace drier can cost more than the decanter centrifuge, but the cost can be shared between neighbouring small mills. The cost of replacing “three-phase driers” with “two-phase driers” may be prohibitive for small isolated installations, due to the economy of scale and/or the lack of opportunity to share the cost between a number of neighbouring installations.

Operational costs at an example extraction installation were reduced by EUR 12 – 24/t olive oil produced. In Andalusia, 30 % of the olives were processed using the new technique within the first two years. It was estimated that during the 1992/93 and the 1993/94 campaigns, ESP 1150 million (about EUR 6.9 million), and ESP 7200 million (about EUR 43.3 million) were invested respectively.

Driving forces for implementation

Complying with the requirements for waste water discharges for a growing sector. State support for the management of the solid waste produced.

The advantages and disadvantages of the two-phase system compared to the traditional systems are summarised in Table 4.96.

Advantages	Disadvantages
Less liquid waste is produced	There is still some waste water production with high contamination (BOD approximately 20000 mg/l), thus waste water treatment is needed
Water savings	The water content of the solid waste is significantly higher
Production costs reduced	Higher costs for storage and transport of the solid waste
More olive oil is produced (higher yield and less by-products)	Higher costs of drying the solid waste
Costs of retrofitting the existing system are low and it is easy	Higher sugar content in the solid waste may cause problems in drying due to caramelisation

Table 4.96: Advantages and disadvantages of two-phase separation compared to the three-phase system in olive oil production

Example plants

Virtually all of the olive oil installations in Spain and over half of those in Croatia. About 25 % of the of olive oil extraction companies in Europe.

Reference literature

[86, Junta de Andalucía and Agencia de Medio Ambiente, 1994, 142, IMPEL, 2002, 211, IMPEL, 2003, 212, The olive oil source, 2004, 251, EC, 2005, 252, Greece, 2005, 253, Spain, 2005]

4.7.4.2 Countercurrent flow desolventiser-toaster (DT) in vegetable oil extraction

Description

After oil extraction, the meal contains 25 – 40 % solvent. The solvent is removed by evaporation in the desolventiser-toaster (DT) by means of direct and indirect steam. The DT vessel has several predesolventising and desolventising/stripping decks. The meal from the extractor enters the DT via the top and arrives at the first predesolventising deck. The predesolventising decks have only indirect steam heating to flash off the surface solvent. This configuration reduces the amount of water condensed on the meal at the stripping sections thereby reducing the energy input needed for the meal drying step following afterwards.

Direct steam is introduced in the system via a sparge steam deck at the bottom of the DT. The steam migrates through the layers of meal on each deck. Herewith a large proportion of the hexane is removed from the meal due to condensation of steam on the meal. The DT demonstrates a true countercurrent flow of live sparge steam and meal. The steam consumption is minimised by the countercurrent flow and the application of predesolventising decks. Vapours from the stripping decks and predesolventising decks are combined inside the boundaries of the DT vessel and re-used elsewhere in the extraction process as a heating medium in the miscella distillation after scrubbing (see Section 4.7.4.3). Due to the contact of steam with the meal, toasting takes place as well. The toasting process inactivates the enzymes, so ensuring optimum protein quality of the meal for use as animal feed and improving its digestibility.

Figure 4.55 shows a flow diagram of a countercurrent flow DT.

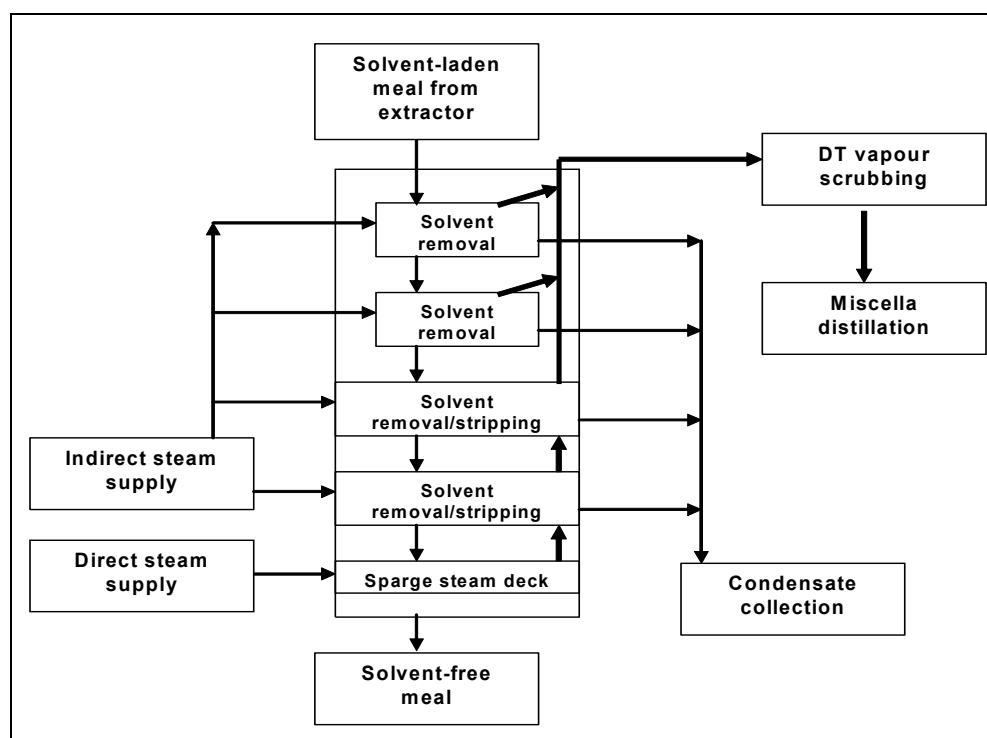

Figure 4.55: Basic flow diagram of a countercurrent flow DT

Achieved environmental benefits

Reduction of solvent loss into the meal and the environment. Reduction in steam consumption for the desolventising and meal drying process. Reduced volumes of waste water. More balanced heat integration with miscella distillation system, so reducing the need for hot and cold utilities.

Operational data

Energy consumption is normally given for the DT and downstream drying operation as a whole. For example, by predesolventising via indirect steam in the top decks the amount of water condensed on the meal at the stripping sections is reduced in comparison with the case when direct steam is applied. Subsequently, the energy input needed for the meal drying step following afterwards is reduced. Table 4.97 shows energy consumption data for the DT and downstream drying operation in oilseed extraction.

Heating steam	15.55 – 31.11	kWh/t
	56 – 112	MJ/t
	20 – 40	kg/t
Stripping steam	54.44 – 116.66	kWh/t
	196 – 420	MJ/t
	70 – 150	kg/t
Electricity for DT drive	2 – 5	kWh/t
	7 – 18	MJ/t

Table 4.97: Energy consumption data for the DT and downstream drying operation in oilseed extraction

It is reported that the countercurrent flow enables the operator to maintain acceptable residual solvent levels in the meal exiting the DT to minimise the hexane loss of the extraction process and also to minimise the temperature of the vapour mixture leaving the DT at the same time. At higher vapour temperatures, the consumption of indirect steam increases.

The DT vapours are re-used in the first evaporator of the miscella distillation system (see Section 4.7.4.3). The final evaporation and stripping is completed with steam. The condensate mixture of water and hexane is separated in a solvent water separator. Hexane is re-used and the waste water is discharged to the WWTP. The waste water contains only COD and Kjeldahl nitrogen.

Applicability

Suitable for new and existing installations. The technique is easily available and has a good operating reliability.

Economics

High initial investment costs. Reduction in energy costs for the extraction installation.

Driving force for implementation

Potential lower residual solvent levels in the meal. Reduction of plant operational costs. Increased plant safety. Ensured operational safety of the downstream process. Compliance with legislation controlling VOCs.

Reference literature

[141, FEDIOL, 2002]

4.7.4.3 Re-use of the vapours from the DT in the miscella distillation in vegetable oil extraction

Description

The DT removes the hexane from the meal (see Section 4.7.4.2). The vapours from the DT stage (steam/hexane mixture) are fed to the first stage of the miscella distillation pre-evaporator to provide a heating source, so recovering energy. A basic flow diagram of the vapour heat integration in the DT is shown in Figure 4.56.

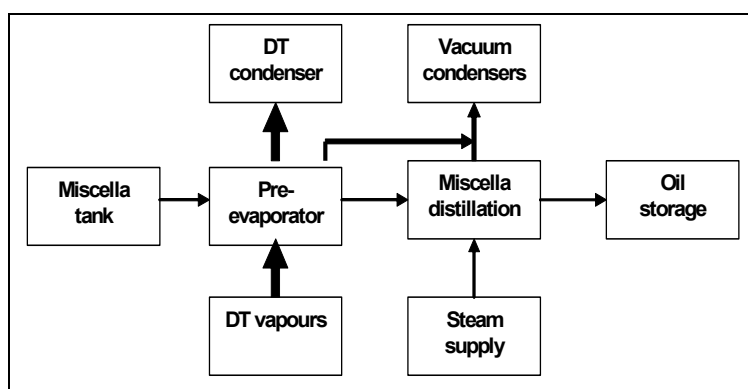

Figure 4.56: Basic flow diagram of the vapour heat integration in the DT

Achieved environmental benefits

Reduced energy and solvent consumption.

Operational data

The reported energy savings in the extraction process amount to approximately 37.5 kWh/t (135 MJ/t) (60 kg steam/t) seed. Energy is also saved by reducing the heat load to the cooling water system of the installation.

In the pre-evaporator, the miscella concentration (% oil in hexane/oil mixture) increases from approximately 20 – 30 % to 60 – 75 %. For example, when processing soya, the pre-evaporator arrangement results in an evaporation of about 0.4 tonnes of hexane per tonne of seed based on the DT vapour waste heat availability. This represents a significant amount of the fresh solvent input to the extraction. The re-use of the energy value reduces the heat load to the DT condenser. Also the steam demand for the downstream miscella distillation is minimised.

Applicability

Widely applicable in oilseed extraction. The technique is easily available and has a good operating reliability.

Economics

High initial investment. Reduction of plant operational costs due to energy recovery.

Driving force for implementation

Optimisation of the miscella distillation energy balance. Improved plant safety. Compliance with governmental energy saving schemes.

Reference literature

[141, FEDIOL, 2002]

4.7.4.4 Re-use of heat in the hardening of vegetable oilsDescription

The hydrogenation reaction that occurs during the hardening of oils to produce fats for cooking, eating and soap making, is an exothermic process. The reaction produces heat of 41.67 - 152.78 kWh/t (150 – 550 MJ/t) of feedstock. The heat generated depends on the feedstock and product specification and range, e.g. if fewer hydrogenated products are made, then less steam is generated. This heat is used to heat the product to the desired reaction temperature and to generate steam later in the reaction.

Achieved environmental benefits

Reduced energy consumption, e.g. improvement in the process efficiency through heat recovery. Reduction in emissions due to energy generation.

Operational data

In an example edible oil refinery, the steam generated is fed into the existing 350000 Pa (3.5 bar) steam main pipe of the installation, thereby reducing the primary steam consumption of the installation as a whole. The reported energy (steam) generation amounts to 25 – 125 kWh/t (90 – 450 MJ/t) (40 – 200 kg/t) unrefined oil. In addition, by using the exothermic energy from hydrogenation, a 5 to 10 % reduction in consumption of primary energy at the selected site is achievable.

Applicability

Widely applicable and good operating reliability. The following issues can restrict its applicability:

- proportion of the entire product specification and range which involves hydrogenation
- the existing energy supply strategy of the installation as a whole, e.g. external supply
- the existing energy mix of the installation as a whole, e.g. ratio of electricity to steam
- type of energy agreements with external suppliers/consumers.

Economics

Additional investment costs are needed. Lower operational costs due to the reduced input of steam generation.

Driving force for implementation

Precautionary energy management.

Reference literature

[65, Germany, 2002, 185, CIAA-FEDIOL, 2004]

4.7.4.5 Mineral oil scrubber to recover hexane

Description

Hexane and steam vapours coming from meal desolventising-toasting, miscella distillation, reboiler and from the stripping column of the mineral oil system, all pass through a condenser. The components that cannot be condensed by the condenser, e.g. very low volume exhaust air with traces of hexane, are absorbed by a mineral oil scrubber.

The mineral oil scrubber consists of an absorption column, where the hexane is absorbed by cold, food grade mineral oil. The hexane-laden mineral oil is then passed through a steam stripping column to recover the hexane. The mineral oil is cooled and re-used in the absorption column.

The hexane and steam vapour from the steam stripping column are condensed in the condenser. The hexane-water condensate then goes to the hexane-water separator. The waste water is decanted in the hexane-water separator and the hexane is recirculated to the extraction process. The process is shown in Figure 4.57.

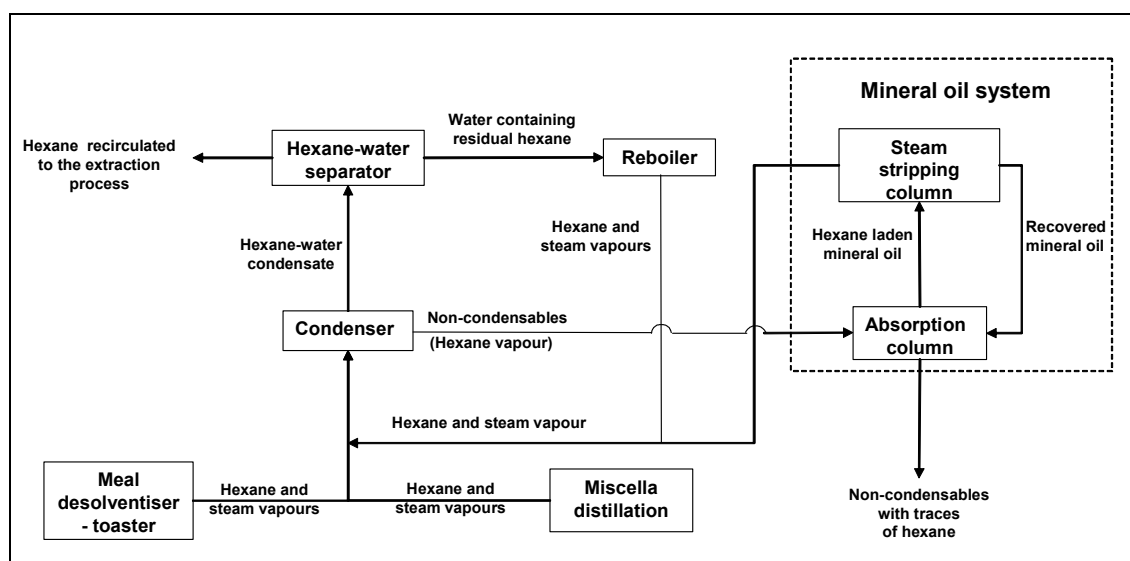

Figure 4.57: Mineral oil system and related process steps [141, FEDIOL, 2002]

Achieved environmental benefits

Recovery of hexane for re-use and consequently lower VOC emission levels.

Cross-media effects

Extra energy consumption, mainly due to heating the mineral oil, using stripping steam and from using electrical power for pumping the oil.

Operational data

Hexane emission concentrations below the lower explosive limit, e.g. approximately 40 g/m^3 , can be achieved. The energy consumption is approximately 25 kg steam/tonne seed and 0.5 kWh/tonne seed.

Applicability

Suitable for existing and new installations, good operating reliability and readily available.

Economics

Investment costs are high and there are extra operating costs due to extra energy consumption. Costs are saved due to hexane recovery.

Driving force for implementation

Higher plant safety, recovery and re-use of hexane, legislation controlling VOC emissions and lack of a better alternative for food grade mineral oil as an absorption liquid.

Reference literature

[141, FEDIOL, 2002]

4.7.4.6 Hexane recovery using a reboiler and gravity separatorDescription

The oil extraction process uses hexane as a solvent. As a consequence, hexane-rich vapour condenses to form process water containing hexane at temperatures of around 50 °C. The undissolved hexane is largely separated by means of a gravitational phase separator, i.e. hexane-water separator.

Any residual solvent content in the aqueous phase of the hexane-water separator is distilled off by heating the aqueous phase to approximately 80 – 95 °C in the reboiler. The resulting hexane-water vapours from the reboiler are condensed together with the vapours from the miscella distillation stage. The uncondensable gaseous matter of the vapours is treated in the mineral oil scrubber after the condenser where residual hexane is absorbed (see Section 4.7.4.5).

All recovered hexane is re-used in the extraction process. After boiling, the almost hexane-free water is fed to the waste water system. This technique also eliminates possible risks of explosion from solvent rich wastes in the downstream waste water treatment system. The process is shown in Figure 4.58.

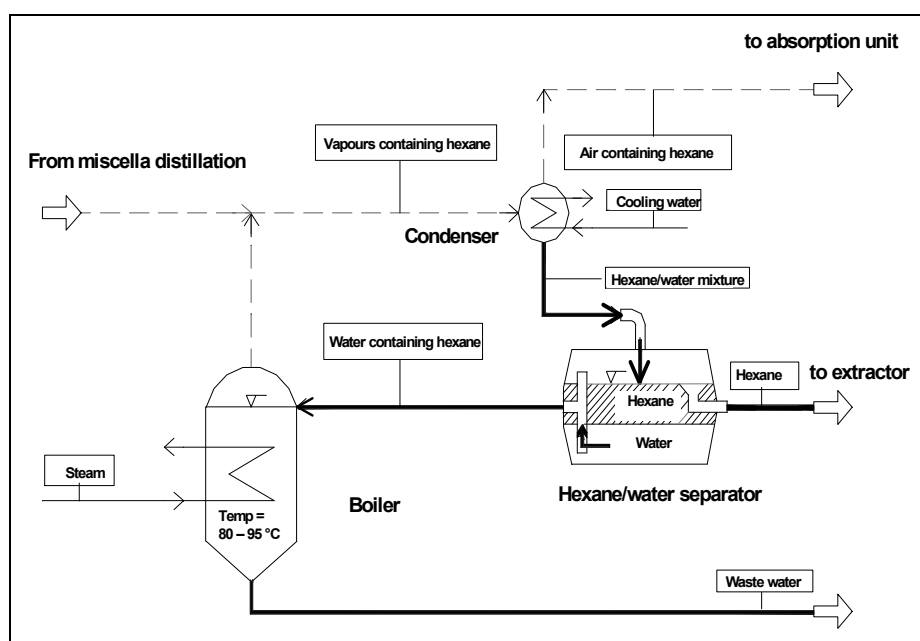

Figure 4.58: Process flow diagram for hexane recovery from process water in the extraction of unrefined vegetable oils

Achieved environmental benefits

Reduced consumption and emission of hexane. The safety of a waste water system is ensured by preventing explosive hexane-air mixtures. Minimisation of solvent losses and COD/BOD load in the waste water.

Cross-media effects

Increased input of heat energy. Increased waste water temperature.

Operational data

Steam is consumed at a rate of 0.778 kWh/m³ water (1 kg/m³). The hexane content in the waste water is less than 3 mg/l. The recovery of hexane is approximately 5 kg/t seed.

Applicability

Universally applicable and readily available, without any restrictions. The operating reliability is very good, due to the multistage design, temperature control and monitoring.

Economics

Reduced costs due to smaller hexane losses and increased costs due to increased energy input.

Driving force for implementation

To ensure plant safety, to meet local waste water limit values for hydrocarbons and to comply with statutory solvent retention requirements, including legislation controlling VOCs, i.e. EC/99/13 and related national legislation.

Reference literature

[65, Germany, 2002, 141, FEDIOL, 2002, 189, Bockisch M, 1993]

4.7.4.7 Refining of vegetable oils

Crude edible oils contain different types of undesirable substances, e.g. 0.5 to 7.0 % ffa, gums (also named phosphatides or phospholipids or lecithin), traces of metals, colouring components and volatile components. The removal of ffa (<0.1 % ffa in refined oil) can be achieved either by chemical or physical refining.

4.7.4.7.1 Chemical refiningDescription

Chemical neutralisation involves the addition of caustic soda at 75 – 110 °C to saponify the ffa, precipitation of soaps in the heavy aqueous phase and removal of the heavy phase, called soap-stock, by using sedimentation or centrifugation. Removal of non-hydratable gums and phosphatide acids can be integrated in this process using a preceding acidification step, i.e. using phosphoric acid or citric acid (see description of degumming in Section 2.2.4.2).

Then, the soap-stock can be further processed into acid oils by splitting or can be sold to a third party and for an integrated installation, there is also an option to recycle it back into the process. In soap-stock splitting, the fatty acid soaps are reacted with sulphuric acid to reform fatty acids. The process can either be continuous or discontinuous. The reaction medium is heated up to 70 – 100 °C to increase the speed of the reaction and to improve the separation of the upper oil phase from the lower aqueous phase. Depending on the amount of phosphatides still present in the crude oil between the aqueous phase and the fatty acids, an intermediate layer of phosphatides can be formed. The chemical refining of vegetable oils is shown in Figure 4.59.

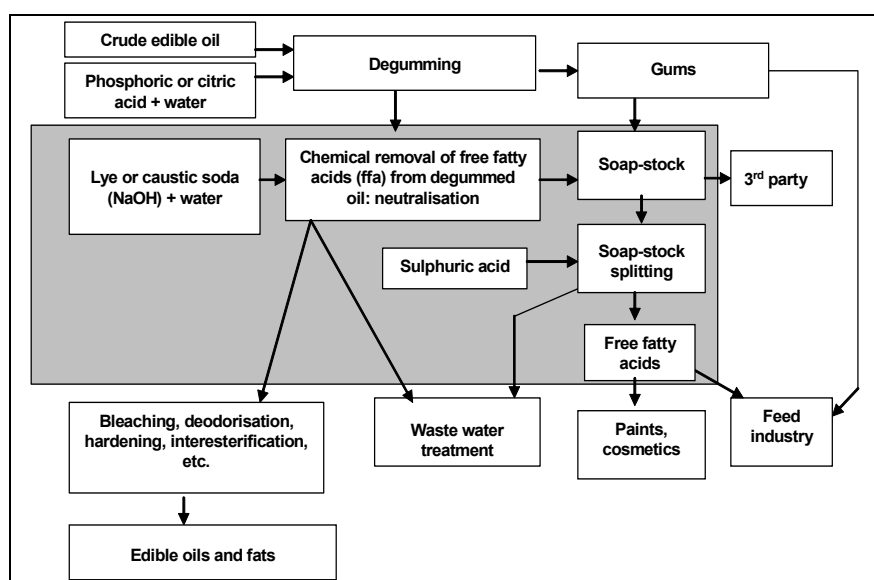

Figure 4.59: Basic flow diagram for the chemical refining of vegetable oils

Achieved environmental benefits

Removal and recovery of ffa. High potential for recovery and upgrade of by-products for animal feed or technical applications in other industries. Reduced input of bleaching earth.

Cross-media effects

The complexity of waste water treatment is increased due to the increased P-load for soap-stock splitting if phosphoric acid is used for degumming; the increased COD/BOD load for soap-stock splitting; the use of citric acid for degumming and the increased sulphate load.

Operational data

It is reported that the consumption of chemicals depends on the composition of the raw material and that its dosing can be reduced by mechanical mixing of chemicals and oils/fats. For example, most of the crude oils have an ffa content of 0.5 to 3.0 %, but others, e.g. crude palm and palm kernel oil, olive oil and coconut oil, have an ffa content of up to 7 % and their consumption data are higher.

Table 4.98 shows consumption and emission levels for the chemical refining of vegetable oils.

Parameter	General data	German example
Caustic soda (100 %) for neutralisation. Amount dependent on the ffa content (maximum 3 %)	1 – 6 kg/t oil	
Steam for neutralisation and soap splitting. Amount dependent on the phosphatide and water content	117 kWh/t soap (150 kg/t) ffa removal	117 kWh/t unrefined oil (150 kg/t)
	156 – 778 kWh/t soap (200 – 1000 kg/t soap) soap-stock splitting	
Phosphoric acid (75 %) for degumming*. Amount dependent on the phosphatide content	0.8 – 5 kg H ₃ PO ₄ /t oil	
Sulphuric acid (96 %) for soap-stock splitting**. Amount dependent on the caustic soda content	100 – 250 kg/t soap	50 – 250 kg/t soap
Water for washing of oil	50 – 300 l/t soap	200 kg/t unrefined oil
Electricity	5 – 15 kWh/t of oil (18 – 54 MJ/t)	
Waste water		
Volume		up to 0.3 m ³ /t unrefined oil
COD		up to 15000 mg/l
Sulphate		up to 15000 mg/l
Organic phosphorus		up to 2000 mg/l
*If instead of phosphoric acid, citric acid is used, there is a potential risk of hydrogenation catalyst (Ni) poisoning by traces of citric acid, thus decreasing the throughput rate of the downstream processes		
**To reduce the sulphate content in the waste water, optimal dosing of sulphuric acid during the soap-stock splitting process is needed		

Table 4.98: Consumption and emission levels for the chemical refining of vegetable oils

Applicability

Suitable for new and existing installations. This technique is suitable for crude oils with low ffa contents, i.e. <3 %. The technique is easily available and has a good operating reliability for an extensive spectrum of raw materials and products.

Economics

The high potential of by-product recovery saves money and there are costs associated with the provision of equipment for acid water handling, treatment and operation.

Driving force for implementation

Better product quality, i.e. lower ffa, a longer shelf-life and a more reliable process. The technique is suitable for an extensive spectrum of raw material and products.

Reference literature

[65, Germany, 2002, 141, FEDIOL, 2002]

4.7.4.7.2 Physical refining

Description

It is possible to remove all the ffa present in the oil in a deodoriser by distillation. A physical pretreatment can be made to achieve a low phospholipid content by degumming and using bleaching earth. Ffa can then be stripped from the physically pretreated oil, by using steam under vacuum at temperatures of around 250 °C. Previous neutralisation processes can be skipped as neutralisation and deodorisation are combined and are performed in continuously operating single or multistage equipment with integrated heat-exchangers and injected stripping steam. This is directly followed by using a scrubber to condense the greater part of the fat from the vapours as a water-free product. This is generally carried out, but depends on the raw material and products and on the incoming oil being rich in ffa and low in phospholipids. The scrubber system located after the deodoriser has to remove a much higher amount of ffa than in the case of normal deodorisation.

Achieved environmental benefits

Recovery of highly concentrated ffa. Reduced chemicals consumption due to the absence of the chemical neutralisation step, i.e. no caustic soda or sulphuric acid is needed. No soap splitting is needed (for a standalone refinery). Physical refining gives a higher oil yield, uses less water and has a reduced production of waste water. Reduced fat, sulphate and phosphate loads in the waste water.

Cross-media effects

The consumption of bleaching earth is up to 4 times higher compared with that for oil that is chemically refined. Increased stripping steam consumption compared to chemical refining.

Operational data

Highly concentrated ffa (up to 85 %) can be recovered. The reported steam consumption is 116.7 – 311 kWh/t of oil (150 – 400 kg/t) and the electricity consumption 15 – 40 kWh/t of oil (54 – 144MJ/t).

Applicability

Suitable for new installations. This technique is suitable for crude oils with high ffa contents, i.e. >2 %, and low phospholipid contents before deodorisation, i.e. approximately 10 ppm or less. The technique is easily available and has a good operating reliability.

Economics

Compared to chemical refining, as there is no chemical neutralisation step, the associated costs are avoided; there are reduced labour costs due to the lack of soap splitting; lower costs for waste water treatment as there is less water pollution and increased costs due to higher bleaching earth consumption. Higher refinery yield compared to chemical refining.

Driving force for implementation

Higher yields, lower environmental load and no acid water.

Reference literature

[65, Germany, 2002, 141, FEDIOL, 2002]

4.7.4.8 Using citric acid instead of phosphoric acid for acid degumming

Description

Citric acid may be used instead of phosphoric acid for degumming, i.e. the removal of phosphatides/phospholipids/lecithins.

Degumming can be carried out separately or integrated with chemical refining, i.e. during neutralisation (see Section 4.7.4.7.1). Degummed oil, i.e. <30 ppm P in the oil, can also be used for further processing in physical refining processes (see Section 4.7.4.7.2).

There are two types of ffa gums; hydratable and non-hydratable. The hydratable gums can be separated from the oil after mixing with water with a centrifuge and added to the meal of an integrated oilseed extraction installation, and then further processed to obtain food grade lecithin or sold as a feedstock raw material.

If the non-hydratable gums and phosphatide acids are first acidified they can then be separated from the crude oil by adding water followed by centrifugation. This process is also called acid degumming. The market demands a phosphorus content lower than 5 ppm in the refined oil. Phosphorus will unavoidably be present in the waste water due to the residues of phosphoric acid and due to the occurrence of organically bound phosphorus in the form of phosphatides. The phosphatides are reportedly not removable by pretreatment. If the acidification is done using citric acid instead of phosphoric acid, the P-load of the waste water can be reduced. The P-load produced by the phosphatide content in the crude oil will not be reduced by the use of citric acid. Citric acid will, however, increase the COD and BOD loads of the waste water. Figure 4.60 shows the process flow for acid degumming.

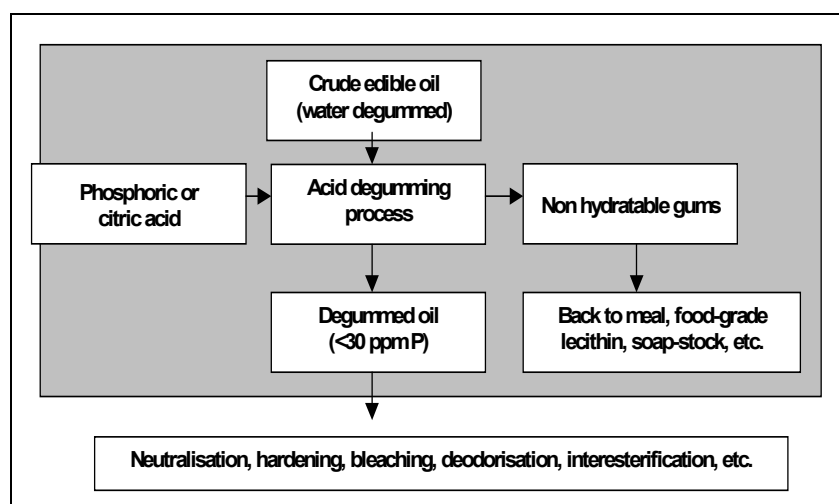

Figure 4.60: Basic flow diagram for the acid degumming of vegetable oil

Achieved environmental benefits

Phosphatides can be further refined to give food grade lecithin as a co-product or added to the meal of an integrated installation, i.e. by-product re-use. Reduced phosphorus load in the waste water. Slight reduction in the amount of sludge.

Cross-media effects

Increased COD and BOD loads of the waste water.

Operational data

A reduction of more than 50 % in the phosphorus load of the waste water is reported, depending on product portfolio. It is also reported that using 1 kg citric acid results in a COD output of 0.75 kg into the waste water. The consumption of citric acid is significantly higher than the consumption of phosphoric acid. The use of citric acid might give problems for the degumming of some types of crude oils with high phosphatide contents.

It is reported that the removal of hydratable phospholipids is done at a temperature of 60 - 70 °C. Whereas the removal of non-hydratable phospholipids requires higher temperatures, e.g. 75 – 110 °C.

Applicability

The technique is universally applicable and suitable for new and existing installations. The use of citric acid instead of phosphoric acid might reduce the throughput rate of the downstream processes. Furthermore, residual citric acid can poison the Ni-catalyst during the hardening process, if the oil is used for margarine production, so this may influence the choice of acid used for degumming. The technique is easily available and has a good operating reliability.

Economics

Reduction in waste water treatment costs. Increase in costs of chemicals. To obtain a good degumming of the crude oil, up to five times more citric acid than phosphoric acid is required. Citric acid has a higher molecular weight and is a weaker acid. The by-products have a saleable value.

Driving force for implementation

Stricter regulation of waste water quality. The value of the by-products, e.g. phospholipids, can influence the choice between separate degumming or integrated degumming ffa removal.

Reference literature

[65, Germany, 2002, 141, FEDIOL, 2002, 189, Bockisch M, 1993]

4.7.4.9 Enzymatic degumming

Description

Physical refining (see Section 4.7.4.7.2) offers lower costs, higher yields and less chemical use for refining crude vegetable oils. A prerequisite for physical refining is a low phosphatide content in the oil entering the final deodorisation stage. The content of phosphatides is reduced in the degumming step. Degumming can be made by enzymatic hydrolysis of phosphatides. The enzyme phospholipase-A₂ catalyses the splitting of the fatty acid ester under mild conditions. The liquid enzyme is dispersed into the oil at 60 °C and at pH 5, with citric acid and caustic soda as a sodium citrate buffer. To increase the low reaction rate of the enzymatic reaction, a battery of continuous stirred reactors is applied. The resulting lysolecithin molecule is water soluble and can be separated by centrifugation.

Achieved environmental benefits

Reduced consumption of caustic soda; phosphoric and sulphuric acids; water and energy.

Operational data

In an example installation, operational problems were observed after the start of production. Emission limit values were achieved within 3 months and costs were reduced significantly by improving the characteristics of the phospholipase.

In the example installation, the conventional method produces a waste water stream of about 3200 kg/h, which also contains sulphate and phosphate, compared to about 400 kg/h for the enzymatic process. In addition, the amount of sludge is reduced by a factor of about 8. Consumption figures for conventional and enzymatic degumming are compared in Table 4.99.

Resource	Unit	Consumption (units/t of crude oil)	
		Conventional method	Enzymatic degumming
Caustic soda (100 %)	kg	5.3	0.43
Phosphoric acid (75 %)	kg	2.0	
Sulphuric acid (96 %)	kg	5.3	
Citric acid	kg		1.0
Soft water	kg	127.8	10.76
Cooling water	m ³	1.5	
Electric power	kWh	7.7	7
	MJ	28	25
Steam	kWh	75	22
	MJ	270	80
	kg	95.5	28
Enzyme solution	kg		0.014

Table 4.99: Consumption figures for conventional and enzymatic degumming of vegetable oil [35, OECD, 2001, 182, Germany, 2003]

Applicability

Can be applied to all types of rape and soya bean oil.

Economics

Costs for conventional and enzymatic degumming are compared in Table 4.100.

Resource	Specific cost (USD/unit)	Total cost	
		Conventional (USD/t oil)	Enzymatic degumming (USD/t oil)
Caustic soda (100 %)	0.6/kg	3.18	0.26
Phosphoric acid (75 %)	0.672/kg	1.34	
Sulphuric acid (96 %)	0.075/kg	0.39	
Soft water	0.013/kg	1.66	0.14
Steam	0.01 – 0.09/kg ³ *	1.24	0.36
Cooling water	0.09/m ³	0.69	
Electric power	0.09/kWh	0.69	0.63
Citric acid	1.87/kg		1.87
Enzyme solution	143.75/kg		2.01
Total	147.173	9.19	5.27
*Difference due to different steam pressure			

Table 4.100: Costs of conventional and enzymatic degumming of vegetable oil [35, OECD, 2001]

Driving forces for implementation

Reduced costs.

Example plants

The technique is used in at least one oilseed crushing, oil refining, oil bottling and packaging installation in Germany.

Reference literature

[35, OECD, 2001]

4.7.4.10 The use of cyclones to reduce wet dust emissions in vegetable oil extraction

Description

The desolventised and toasted flakes from oil processing are passed to a drier, where excess moisture is removed by heated ambient air, and then finally to a cooler, where ambient air is used to reduce the temperature of the dried meal. The exhaust air from the drying and cooling contains dust. Due to the relatively high humidity of the exhaust air from the drying stage, the dust is moist and sticky and presents an especially difficult collection situation. The dust is removed using cyclones and is then returned to the dried meal which can be used, e.g. for animal feed. Figure 4.61 shows a basic flow diagram of a wet dust emission separation by cyclones.

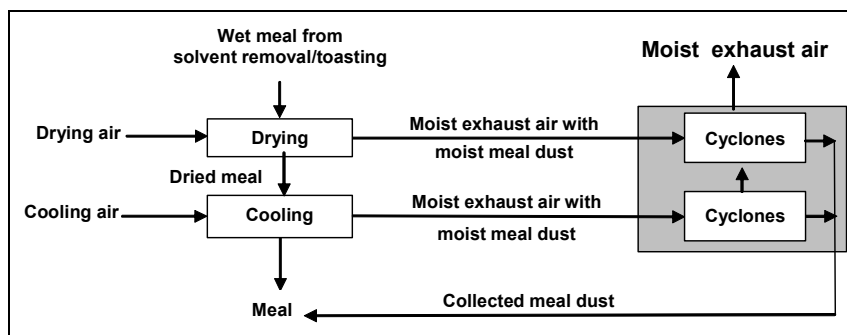

Figure 4.61: Basic flow diagram of wet dust emission separation by cyclones

Achieved environmental benefits

Reduced dust emissions, recovered product and reduced fire risk.

Cross-media effects

Electrical energy is used to overcome the pressure drop in the cyclones.

Operational data

Cyclones are used for practical and safety reasons.

The use of fabric filter systems would lead to the condensation of the moisture, causing a deposition of dust and blockage of ducts. The combination of hot drying air and deposited meal dust can eventually result in the self-ignition of the dust, which could start a fire. Such fires present an especially hazardous situation because of the proximity of the hexane-wet flakes in the preceding desolventising-toasting section.

Electrostatic precipitators also create a fire and explosion risk due to sparking in combination with incidental high hexane concentrations in the exhaust air. The fine moist and sticky meal particles tend to agglomerate, causing the fraction of fine particles in the exhaust gases to be relatively low. In this sense, these separators, normally designed for removal of fine particles, are not suitable. Furthermore, the dried meal particles would become wet in the scrubber and the collected meal would then have to be dried again.

The use of cyclones is reported to have good operating reliability and availability. Wet dust emission concentrations of $<50 \text{ mg/Nm}^3$ are achieved.

Applicability

Applicable in new and existing installations.

Economics

There is an investment cost for the cyclones and transport systems for the recovered meal. Operating costs are high, e.g. due to extra energy consumption.

Driving force for implementation

Reduced product losses and prevention of fires. Also, the technique is reported to be technically and operationally good.

Reference literature

[141, FEDIOL, 2002]

4.7.4.11 Water ring pumps for generating an auxiliary vacuum of 40 to 120 mbar

Description

Water ring pumps generate a low stable vacuum which can be used for degassing and drying of oils and fats of animal and vegetable origin. When degassing the oil, the vacuum is used during hydrogenation, where H₂ is used, and after interesterification, where water is used to inactivate the catalyst. When drying the oil, vacuum is used after degumming, after neutralisation, before and after interesterification and before hydrogenation. Vacuum is also used to ensure an oxygen free atmosphere in the reactor/evacuating reactor during hydrogenation and interesterification.

Achieved environmental benefits

Reduced energy requirements. Low pollution of the waste water. Reduced emissions from energy generation.

Cross-media effects

Generation of waste water.

Operational data

Waste water results from the water used to drive the pumps. This is generally characterised by a low specific volume per unit. Owing to the applications, such water is only slightly polluted at the point of origin, even if it contains condensates from the drying processes. The load can be described in terms of its COD level, because nitrogen or phosphorus compounds cannot be carried into such water in significant quantities under the prevailing process conditions, e.g. temperatures ≤100 °C. The reported volume of waste water is of up to 1.7 m³/t unrefined oil and the COD level is of up to 75 mg/l.

Applicability

Applicable when a vacuum range of 40 to 120 mbar is required. It is readily available and its operating reliability is very good, allowing series production. The technique results in a low throughput.

Economics

Reduced costs due to appropriate vacuum conditions.

Driving force for implementation

Diversity of systems concerned. Completely different vacuum conditions than for distillative neutralisation/deodorisation.

Reference literature

[65, Germany, 2002, 189, Bockisch M, 1993]

4.7.4.12 Deodorisation

Deodorisation is the final treatment step in the refining process that converts crude oil to finished oil. The pretreated oil is heated up to the deodorising temperature, i.e. 180 – 270 °C, using a heat-exchanger and indirect steam. To prevent oxidation of the oil, the atmosphere in the deodorising equipment is at almost absolute vacuum, i.e. 0.5 – 8 mbar. At the given vacuum and temperature conditions, stripping steam provides the driving force and the carrier for removing volatile components from the feedstock.

The vapours from the deodoriser vessel contain air, water vapour, fatty acids and other volatiles. Prior to entering the vacuum equipment, the vapours pass a scrubber. A scrubbing liquid is sprayed in the vapour stream. Fatty acids and volatiles partly condense on the scrubbing droplets or alternatively on the packing material. Since the scrubber is at the same vacuum as the deodoriser, water vapour will not condense.

The pre-cleaned vapour stream now enters the booster steam ejector of the multistage vacuum system. The steam jet is a thermo compressor and hence the vapour pressure increases up to 30 – 50 mbar. In a classical designed vacuum system, the vapours are then condensed in an open barometric condenser. The water vapour coming from stripping steam and pressurised steam are condensed and a tremendous reduction in volume is achieved. This contributes to maintaining the vacuum at the specified levels. Non-condensable components from the barometric main condenser are removed by a de-aerating system comprising one or more small intermediate condensers and one or more small steam ejectors. The condensers also use cooling water, i.e. 10 – 15 % of the cooling water flows through the main condenser. The water from the barometric condensers may be polluted. The function of 1 or 2 steam jets may be replaced by the application of a water ring vacuum pump (see Section 4.7.4.11).

Sections 4.7.4.12.1 – 4.7.4.12.3 describe some techniques used for deodorisation. Table 4.101 shows a comparison of the cooling systems used for vacuum generation in vegetable oil deodorisation based on generating a moderate vacuum of approximately 4 mbar.

Cooling systems for vacuum generation	Steam	Electricity	Total primary energy input	Waste water	Investment costs	System complexity
Once-through system	–	++	++	--	++	++
Alkaline loop	--	+	-/+	–	+	+
Alkaline loop with chiller	+	–	–	+	–	–
Dry condensing	++	--	–	++	--	--
+ (++) = (most) favourable – (--) = (most) unfavourable Note: The total primary energy input for the specified vacuum system is the sum of the amount of energy needed in the plant for generating steam and the energy input in the external power plant to produce the electricity needed.						

Table 4.101: Comparison of cooling systems for vacuum generation in vegetable oil deodorisation [141, FEDIOL, 2002]

4.7.4.12.1 Double scrubber in combination with a once-through cooling system in vegetable oil deodorisation

Description

Deodorising vapours are treated in a scrubber. The pre-cleaned vapour stream is mixed with the driving steam from the booster steam jet. Installing a second scrubber between a booster steam jet and the main condenser allows a further condensation of the volatiles, replacing the stripping and driving steam prior to the mixing with cooling water in a once-through cooling system. The second scrubber may have fixed packing material or may be equipped with a dedicated scrubbing loop, a heat-exchanger to remove the heat of condensation and a demister pad. The second scrubber operates at a higher pressure and due to the addition of steam, via the booster steam jet, the partial pressure of the volatiles is reduced. These two factors provide the basis for further condensation.

The double scrubber arrangement results in an improved scrubbing efficiency of the deodorising vapours. The additional condensation of volatile components in the second scrubber reduces the mass flow through the system. At the same time, the second scrubber contributes to an additional heat loss, however, the total energy requirements for the system are low.

The cooling water is surface water that is returned into the environment after passing a fat trap. The presence of fatty material in the cooling water is very limited. In addition, the use of the second scrubber reduces the pollution load of the cooling water and improves the environmental profile of the cooling system.

Figure 4.62 shows a basic flow diagram of the process.

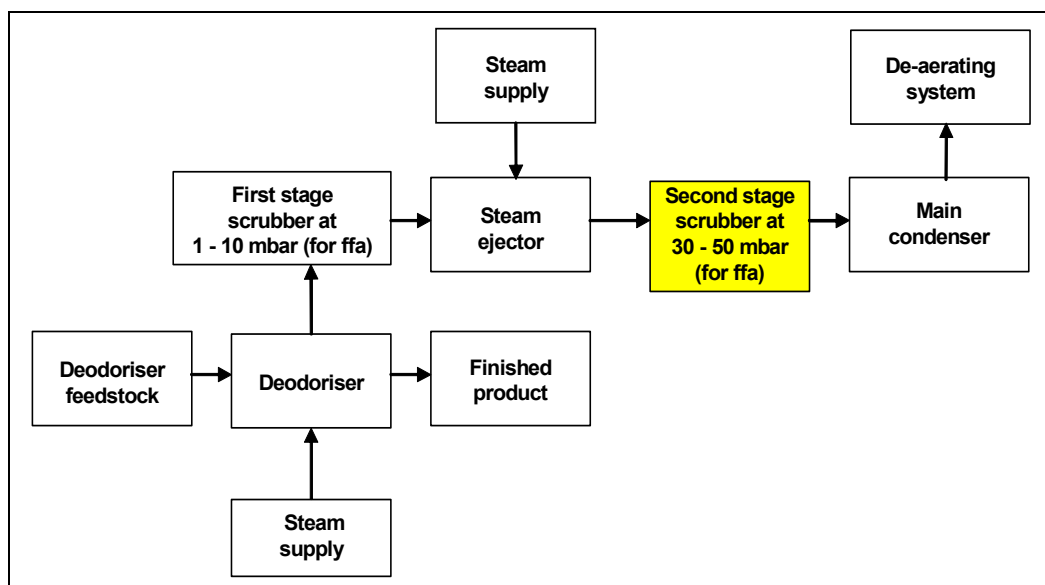

Figure 4.62: Basic flow diagram of the double scrubber arrangement in deodorisation

Achieved environmental benefits

Low energy requirements for the vacuum system. Reduction of the COD pollution. Higher by-product recovery compared to the single scrubber once-through cooling system.

Cross-media effects

Electricity consumption for the second scrubber loop.

Operational data

The scrubbing efficiency of the first scrubber is well above 90 % when the feedstock is chemically refined. This treatment step achieves the initial removal of the bulk of the fatty acids. The second scrubber adds another 2 – 5 % to the overall scrubbing efficiency. The scrubber efficiency is related to the input of fatty acids with the deodoriser feedstock.

It is reported that the double scrubber arrangement combined with a once-through cooling system has no heat-exchangers. Hence there are no problems with either heat-exchanger fouling, or related to poor heat transfer issues. Process stability is high due to the simplicity of the system layout.

As the cooling system design is based on steam ejectors and open condensers with direct cooling water, it has the lowest energy requirement for generating the desired vacuum based on the consumption of electricity and steam. However, this system produces a cooling water flow with increased COD levels. The increase in COD levels may vary from 50 – 150 mg/l depending on the cooling water flow and the quality of the deodoriser feedstock. The double scrubber arrangement results in a lower increase of COD levels, i.e. 40 – 100 mg/l. The reported waste water volume is 1 – 10 m³/t unrefined oil. Table 4.102 shows energy data of a double scrubber combined with a once-through cooling system.

Energy consumption	Specific values
Electricity (depends on the content of ffa in the unrefined oil)	2 – 5 kWh/t unrefined oil
Steam	39 – 50 kWh/t (50 – 100 kg/t unrefined oil)

Table 4.102: Energy data of a double scrubber combined with a once-through cooling system

Applicability

Suitable for existing and new installations, good operating reliability and readily available. The deodoriser feedstock quality should not contain high concentrations of short-chain fatty acids, e.g. coconut oil. Space availability is needed for the second scrubber.

Economics

Investment costs are needed for the second scrubber. Reduced plant operational costs.

Driving force for implementation

Ensures operating stability of the deodoriser vacuum system. Compliance with water pollution legislation and government energy saving schemes.

Reference literature

[141, FEDIOL, 2002]

4.7.4.12.2 Single scrubber in combination with an alkaline closed-circuit system in vegetable oil deodorisation

Description

Deodorising vapours are treated in a fatty acid scrubber. The pre-cleaned vapour stream is mixed with the driving steam from a booster steam jet. When the deodoriser feedstock contains higher concentrations of short-chain fatty acids, e.g. coconut oil, the installation of a second scrubber between the booster steam ejector and the main barometric condenser will not reduce the COD pollution load from the once-through system to an acceptable level. In such cases, the overall assessment of the technique may conclude that the pollution load of the cooling water return is not acceptable despite the low energy requirements of the once-through cooling system. In this case or in similar situations, alkaline closed-circuit systems can be applied. The installation of a closed-circuit system makes the investment in a second scrubber obsolete.

In this cooling system, the cooling water is circulated in a closed-circuit and the volatile components of the deodoriser vapour stream are mostly trapped in the main condenser. The main and intermediate condensers of the vacuum system may be part of the internal cooling water circuit, with a bleed to the waste water treatment system of the installation via the soap splitting plant. Two heat-exchangers need to be installed to allow for cleaning. Caustic needs to be added to avoid rapid fouling by fatty material. The pH is raised to approximately 9 in the primary barometric condenser circuit. The condensate from the oil stripping steam and the ejector steam provides the water needed in the alkaline circuit. Excess water is withdrawn from the alkaline circuit as a soap solution. Soap splitting is carried out in a separate department. The aqueous phase is part of the acid waste water. The introduction of a closed-circuit system increases the steam consumption needed for generating the same vacuum.

The inlet temperature to the main condenser is 5 °C higher than with the open condenser system, which incurs a higher steam consumption on the steam ejectors and hence higher cooling water demands. This can make this process impossible under the given physical conditions necessary for product quality. Also, the internal closed-circuit may be chilled resulting in increased consumption of electricity and a lower driving steam consumption. In this case, the cooling water circuit operates at a lower temperature level because it is cooled by a chiller. This system is generally used during higher ambient temperatures, e.g. in summer.

Figure 4.63 shows a basic flow diagram of an alkaline closed-circuit cooling water system as part of a deodoriser vacuum system.

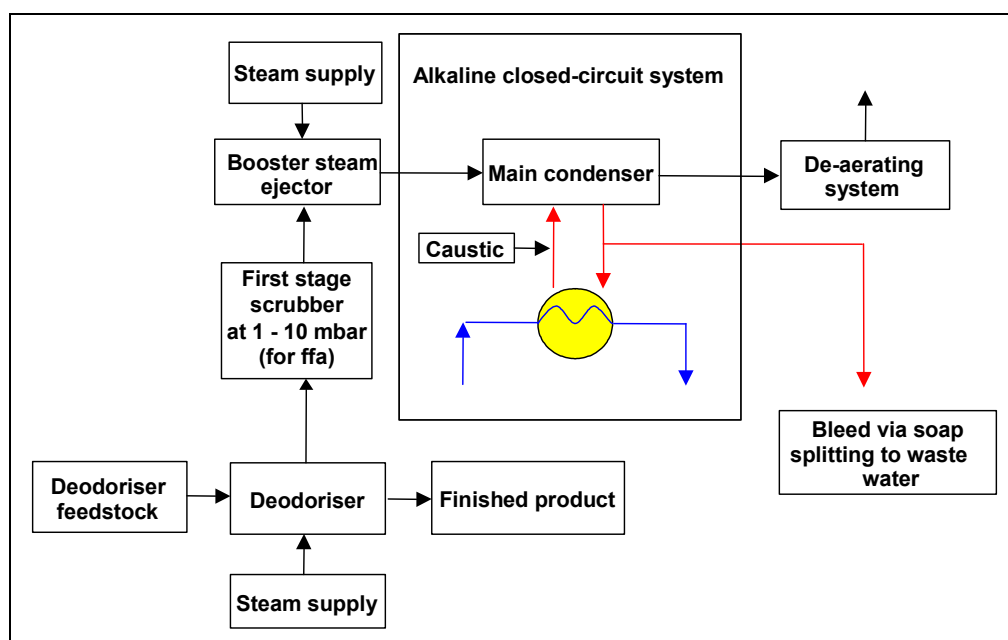

Figure 4.63: Basic flow diagram of an alkaline closed-circuit cooling water system as a part of a deodoriser vacuum system

Achieved environmental benefits

Chilled alkaline closed-circuit systems eliminate the COD pollution load of the waste water and reduce the waste water load. The closed-circuit reduces the fresh water requirements.

Cross-media effects

Increased input of caustic soda for the alkali circuit. Increased use of sulphuric acid for soap splitting. Increased volume of acid water. Increased load to the WWTP. Increased consumption of electricity and steam. Increased safety and environmental risks related to the use of refrigerants, e.g. ammonia.

Operational data

A 99 % waste water volume reduction has been reported in comparison to once-through cooling (see Section 4.7.4.12.1). The volume of waste water generated is 0.06 – 0.15 m³/t unrefined oil. It is reported that when using a closed-circuit system, the complexity increases and the reliability decreases. Closed-circuit systems involve internal heat-exchangers, extra pump capacity and chiller installation. The energy requirements for the deodorising step in a refinery involve more than 50 % of the refinery's total energy consumption. Closed-circuit alternatives, therefore, result in 10 – 20 % higher specific energy consumption values. Table 4.103 shows energy data of an alkaline closed-circuit system.

Energy consumption	Specific values	
	German example installation data	Reported data
Electricity (depends on content of ffa in the unrefined oil)	8 – 10 kWh/t unrefined oil	8 – 20 kWh/t unrefined oil
Steam	47 – 117 kWh/t unrefined oil (60 – 150 kg/t)	39 – 117 kWh/t unrefined oil (50 – 150 kg/t)

Table 4.103: Energy data of an alkaline closed-circuit system

Applicability

Applicable when the deodoriser feedstock contains higher concentrations of short-chain fatty acids, e.g. coconut oil. Suitable for new and existing installations, and readily available. The space availability may restrict its application.

Under hot climate conditions, where there is a higher risk of process instability, e.g. vacuum fluctuations, the operating reliability is acceptable, in combination with adequate process controls. Under moderate climate conditions and after treatment for the removal of fats from the deodoriser vapours, if the technique is correctly operated its reliability can be very good, mainly due to the robust steam-jet vacuum pumps.

Economics

Closed-circuit systems have higher investment costs, operational costs and energy consumption compared to once-through systems. In addition, higher investment costs are reported for chilled closed-circuit systems.

Reference literature

[65, Germany, 2002, 141, FEDIOL, 2002, 189, Bockisch M, 1993]

4.7.4.12.3 Single scrubber in combination with a dry condensing system in vegetable oil deodorisation

Description

Dry condensing (DC) systems, also called ice condensing systems, are placed between the scrubber and the de-aerating system. The scrubber removes the major part of the ffa. The DC system takes out the remaining part of the ffa and the stripping steam that was used to drive out the ffa. The steam and ffa are condensed on the coils (heat-exchanger) of the DC system at temperatures as low as -30 °C. The low temperature is generated by the mechanical compression of ammonia and evaporates it in the coils afterwards. The chiller unit requires extra electricity and cooling water. Only the non-condensable vapours will pass the scrubber and the DC system to the vacuum system. Figure 4.64 shows a basic flow diagram of a single scrubber in combination with a DC system.

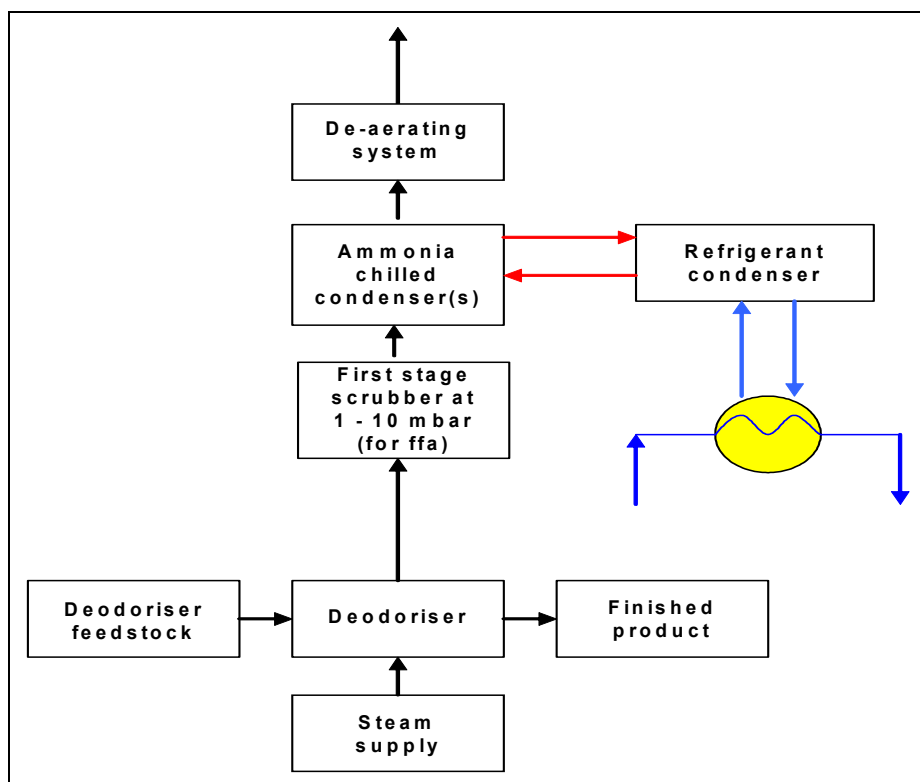

Figure 4.64: Basic flow diagram of a single scrubber in combination with a DC system

Achieved environmental benefits

Recovery of highly concentrated fatty acids. Reduced water consumption. Reduced waste water volume and load. Reduced steam consumption.

Cross-media effects

Increased input of electricity due to the refrigeration system. The use of ammonia for refrigeration results in an occupational health hazard and safety issue due to potential ammonia releases.

Operational data

It is reported that more than 95 % of all the condensable vapours are removed by the DC system, so the vacuum system can be much smaller. Table 4.104 shows performance data from a case study of a DC system.

Consumption level	Specific values
Water for water ring pumps and for cooling the refrigeration plant for ice condensation	300 kg/t unrefined oil
Electricity (depends on the content of ffa in the unrefined oil)	10.5 – 21.5 kWh/t unrefined oil
Steam	5.5 – 15.5 kWh/t (20 – 150 kg/t) unrefined oil
Waste water	Up to 0.350 m ³ /t unrefined oil. No phosphate or sulphate

Table 4.104: Performance data of an example DC system

Applicability

Applicable when applying distillative neutralisation/deodorisation (physical refining). Suitable for new and existing installations. The space, low vapour fat contents, installation capacity and external safety requirements, e.g. due to the application of ammonia in the refrigeration system, can restrict its applicability. The operating reliability is good, thanks to control technology. The vacuum system is better as it is independent of weather conditions.

Economics

High investment costs. Increased electricity costs. High maintenance costs. Reduced need for steam. Increased costs for electrical energy. Reduced costs due to lower steam and cooling water consumption.

Driving force for implementation

Possibility to create deeper vacuums to meet stricter product requirements. Water savings. Compliance with water pollution legislation.

Reference literature

[65, Germany, 2002, 141, FEDIOL, 2002, 189, Bockisch M, 1993]

4.7.5 Dairy products

4.7.5.1 Segregation of outputs, to optimise use, re-use, recovery, recycling and disposal (and minimise water use and waste water contamination)

This technique is described in Section 4.1.7.6.

Reported examples of where the technique is applied

There are likely to be many other opportunities to apply this technique within the sector.

- collect leaked and spilt ingredients and partly and fully processed materials
- collect whey which is not intended for making mitzithra cheese, baby food or other products
- collect milky waste water generated at the start-up of pasteurisers
- keep the solid waste obtained after centrifugation from entering the waste water
- collect and recover product/product mixtures from product change-overs
- separate and collect buttermilk, first rinses and residual fat in butter churning operations, to use it in other processes, e.g. as a base for low fat spreads
- collect rinsings from yoghurt vats
- collect the drainings of yoghurt and fruit throughout the dairy
- collect and empty the products from wrongly filled containers for use as animal feed, e.g. by maceration of packaging.

Applicability

Applicable to all dairies.

Reference literature

[13, Environment Agency of England and Wales, 2000, 39, Verband der Deutschen Milchwirtschaft (German Dairy Association), 2001, 42, Nordic Council of Ministers, et al., 2001, 74, Greek Ministry for the Environment, 2001, 134, AWARENET, 2002]

4.7.5.2 Dry cleaning

This technique is described in Section 4.3.1.

Reported examples of where the technique is applied

There are likely to be many other opportunities to apply this technique within the sector.

- adopt dry cleaning methods to collect the solid residues from cheese production
- sweep curd losses instead of washing them to the drain
- treat spills of curd, yoghurt or ice-cream mix as waste rather than just washing them to the drain
- use dry processes to collect excess salt rather than just washing it to the drain
- fit drains with screens and/or traps to prevent any solid material from entering the waste water.

Applicability

Applicable to all dairies.

Reference literature

[13, Environment Agency of England and Wales, 2000, 39, Verband der Deutschen Milchwirtschaft (German Dairy Association), 2001, 42, Nordic Council of Ministers, et al., 2001, 74, Greek Ministry for the Environment, 2001, 134, AWARENET, 2002]

4.7.5.3 Partial homogenisation of market milk

Description

The cream is homogenised together with a small proportion of skimmed milk. The optimum fat content of the mixture is 12 %. The rest of the skimmed milk flows directly from the centrifugal separator to the pasteurisation section of the pasteuriser. The homogenised cream is remixed into the skimmed milk stream before it enters the final heating section. Using this technique, the size of the homogeniser can be significantly reduced, leading to energy savings.

Achieved environmental benefits

Reduced energy consumption.

Operational data

In an example dairy, the introduction of partial homogenisation into a pasteurisation line with a nominal capacity of 25000 l/h led to a reduction in the homogenisation capacity to 8500 l/h. The total electrical power was reduced by about 65 % by installing a smaller homogeniser of 55 kW.

Applicability

Applicable in dairies.

Economics

Smaller homogenisers are cheaper in terms of investment costs and operational costs. The price of the smaller homogeniser is about 55 % of the price of a piece of equipment with the capacity to treat the nominal capacity of the line.

Driving force for implementation

Lower investment and energy costs.

Example plants

It is widely used in modern dairies.

Reference literature

[42, Nordic Council of Ministers, et al., 2001]

4.7.5.4 Use of computer controlled milk transfer, pasteurisation, homogenisation and CIP equipment

Description

An example dairy installation (also described in Section 4.7.5.9) receives 450000 litres of milk, at a quality complying with the Directive 92/46/EEC. The installation requires its suppliers to use mechanical milking, have proper refrigeration capacity and to apply HACCP. The flow sheet for the processing in the installation is illustrated in Figure 4.65.

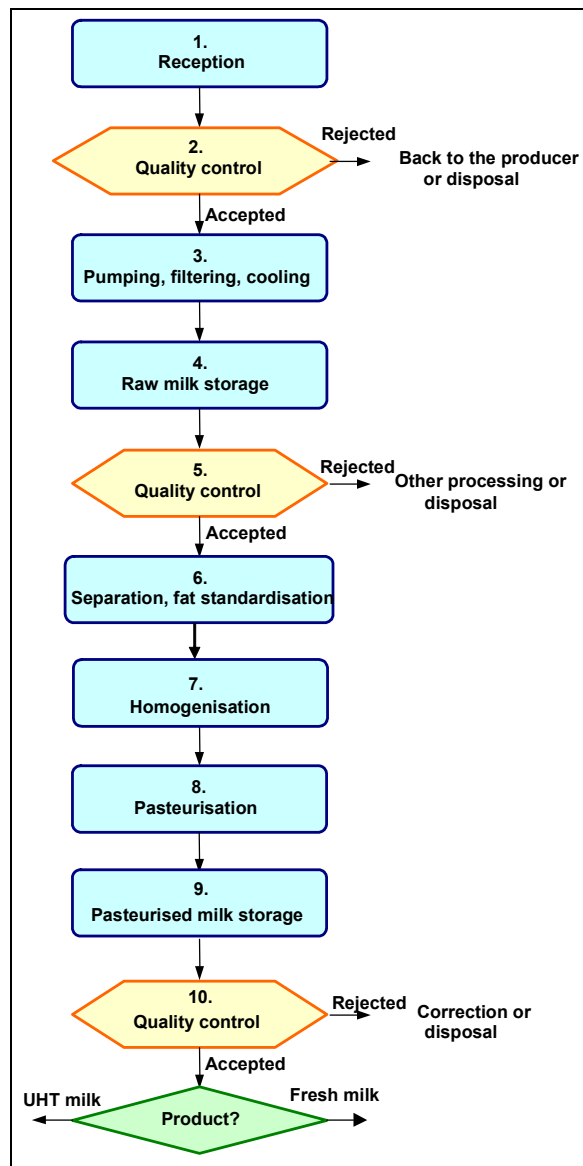

Figure 4.65: Processing flow sheet for a dairy producing milk

The milk reception is via two parallel PLC-controlled closed systems. The introduction of a technique using special valves, has significantly reduced the milk losses. It is reported that where the valves have been introduced, milk losses during transfer between pipes, when filling tanks and human errors have been totally eliminated, thus waste water pollution from that source, has decreased.

The milk is also pasteurised by computer controlled plate heat-exchangers, which have a greater surface area for heat-exchange than others and are equipped with automatic fat standardising and homogenising units.

The processing is carried out in a closed system. The control for storing and pumping the raw materials, intermediaries, and products to the different processing units of the installation is carried out by a computer aided system. Using this system, the losses have been minimised. The same control system operates the CIP system. Here, the last rinsing water is used for the next cleaning circle.

The pasteurised fresh milk is packed in PE bags or PET bottles.

Achieved environmental benefits

Reduced milk wastage and waste water contamination. The computerised CIP system also led to reduced water and reagent savings.

Operational data

During pasteurisation, the greater surface area for heat-exchange and the recirculation of warm water reportedly results in about 25 % savings in energy consumption and about 50 % savings in water consumption, in comparison with the old pasteuriser previously used.

The computerised process control avoids or decreases milk losses in reception and during further processing.

The automatic dosing reportedly results in about 15 % savings both in water and in the consumption of cleaning and disinfecting agents.

Applicability

Applicable in both new and existing installations.

Economics

Investment costs are high.

Driving force for implementation

Reduced costs for energy and water.

Example plants

At least one dairy in Hungary.

Reference literature

[148, Sole, 2003]

4.7.5.5 Use of continuous pasteurisersDescription

In continuous pasteurisation, flow-through heat-exchangers, e.g. tubular, plate and frame, are used. These have heating, holding and cooling sections. To reduce energy consumption and waste water generation, continuous pasteurisers are used instead of batch pasteurisers.

Achieved environmental benefits

Reduced energy consumption and waste water production, compared to batch pasteurisers.

Operational data

Batch wise pasteurisation uses a temperature of 62 to 65 °C for up to 30 minutes. Continuous pasteurisers include high temperature short time pasteurisation (HTST) and high heat short time pasteurisation (HHST). HTST uses a temperature of 72 to 75 °C for 15 to 240 seconds. HHST applies a temperature of 85 to 90 °C for 1 to 25 seconds.

Applicability

Applicable in dairies.

Economics

Reduced energy and waste water treatment costs.

Reference literature

[134, AWARENET, 2002]

4.7.5.6 Regenerative heat-exchange in a pasteurisation processDescription

Pasteurisers are normally equipped with some regenerative countercurrent flow heating sections. The incoming milk is preheated with the hot milk leaving the pasteurisation section.

Achieved environmental benefits

Reduced energy consumption.

Operational data

Typically energy savings over 90 % can be achieved.

It is reported that, in an example dairy, by applying indirect heat-exchange between the after-thermal treatment product and the inlet product, the specific energy consumption of 148000 kcal/t can be reduced by 80 %, i.e. to 29000 kcal/t. The reported temperatures of the process are as follows:

- initial temperature of 4 °C
- regeneration heating temperature of 65 °C
- pasteurisation temperature of 78 °C
- regeneration cooling temperature of 20 °C
- pasteurised milk temperature of 4 °C.

Also, heat-exchangers have reportedly been applied in the dairy between the inlet cold product, i.e. cold milk, and the steam coming from the extraction during vacuum expansion after UHT treatment. The specific energy consumption of 251000 kcal/t can be reduced by 26 %, i.e. to 185000 kcal/t. The reported temperatures of the process are as follows:

- initial milk temperature of 4 °C
- regeneration heating temperature of 70 °C
- UHT treatment temperature of 140 °C
- UHT milk filling temperature of 25 °C.

Another reported example comes from a new dairy, where nine plate exchangers were installed with higher regenerative efficiencies. Calculations were made for increasing the efficiency from 85 to 91 % or from 91 to 95 %. Savings in heating energy of 2712 MWh/yr and in electricity of 542 MWh/yr were estimated, with an investment cost of EUR 370000 and a payback of 3.6 years.

Applicability

It is widely applied in dairies. In older dairies, heating and cooling energy can be further reduced by replacing the old plate exchangers by more effective ones.

Economics

Reduction in energy costs.

Driving force for implementation

Reduction in energy costs.

Example plants

A dairy in Denmark.

Reference literature

[42, Nordic Council of Ministers, et al., 2001, 75, Italian contribution, 2002]

4.7.5.7 Reduce cleaning requirements of centrifuges by improved preliminary milk filtration and clarification

Description

By improving the preliminary milk filtration and clarification processes, the deposits in the centrifugal separators are minimised, leading to a reduction of the frequency of cleaning.

Achieved environmental benefits

Reduced water consumption and waste water pollution.

Applicability

Applicable in dairies.

Reference literature

[134, AWARENET, 2002]

4.7.5.8 Two-stage drying in milk powder productionDescription

After the milk has been thickened from 11 % to 50 – 60 % dry matter in an evaporator, the condensed milk may further be dried to 95 – 97 % dry matter content. Spray driers or roller driers are used in milk powder processing. Although roller driers may be found in the dairy sector and are sometimes useful for specialised products, spray driers with downstream or integrated FBDs have become more common (see Figure 2.13). This is due to their lower energy usage, the primarily dust-free product, and due to their reduced thermal stress.

A spray drying process using a downstream FBD is also called two-stage drying. Figure 4.66 shows a two-stage drying process carried out by using a spray drier with a rotary atomiser and a separate external FBD. The outlet air is filtered by a CIP filter, which consists of a tubular filter without cyclone (see Section 4.4.3.7.1).

When using two-stage drying, lower residual product moisture with less harm to product quality as well as more efficient energy utilisation can be achieved. The solids leave the spray drier with 3 – 5 % residual moisture. The final drying step takes place under mild conditions with low energy usage.

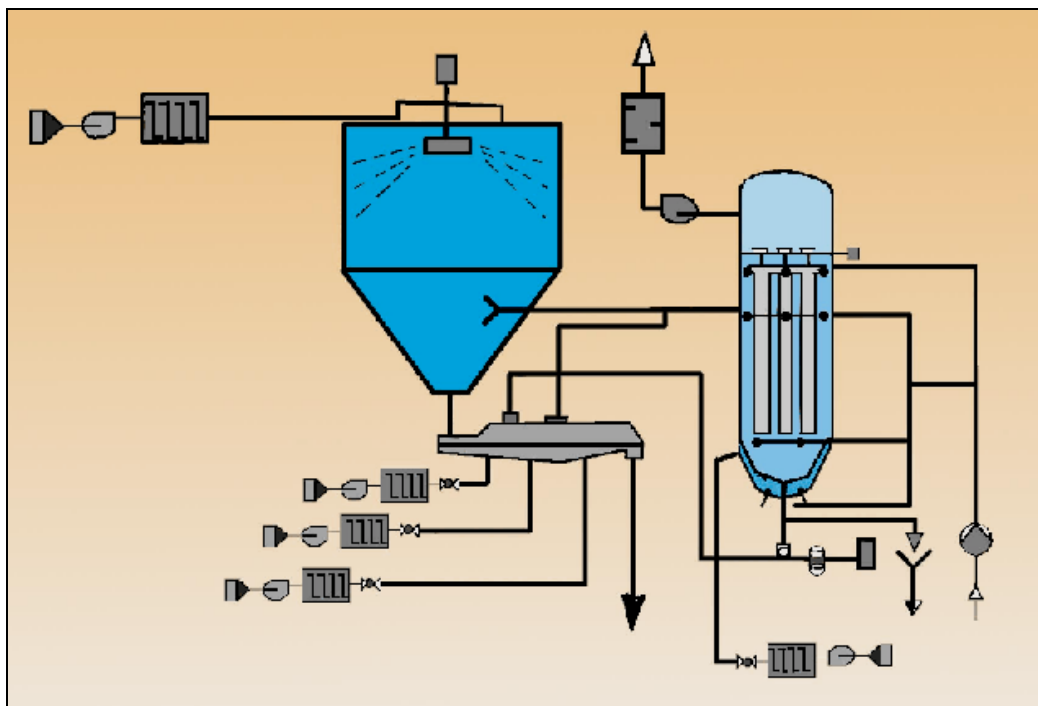

Figure 4.66: A two-stage drying process in a large dairy

Achieved environmental benefits

Reduced energy and water consumption. Reduced dust emissions.

Cross-media effects

Spray driers produce noise emissions and explosive dust/air mixtures can occur.

Operational data

A large dairy in Germany produces skimmed milk and sweet whey powder. It processes 240000 t of raw milk and produces 19000 t milk and whey powder. The dairy uses a two-stage drying system with a capacity of 1 t/h. The waste gas volume is 45000 m³/h. The drying process uses the largest share, i.e. 58 %, of the thermal energy consumption of the installation, i.e. 39 million kWh out of the total consumption of 67.5 million kWh, in 2000. About 30 % of the total power consumption, i.e. 18 million kWh, was reportedly attributed to the drying process.

In this example dairy, the reported specific electricity consumption was 315.8 kWh/t product or 25 kWh/t raw milk. The specific thermal energy consumption was 2052.6 kWh/t product or 162.5 kWh/t raw milk. Taking into account that about 600 kWh energy is required to evaporate 1 tonne of water, these figures are near to the theoretical energy need. The total water consumption of the drying step was also low, i.e. 9500 m³ or 0.5 m³/t product or 0.04 m³/t raw milk.

It is reported that if an integrated FBD is used, the energy consumption for drying can be reduced by approximately 20 %. Investment involves additional capital and operational costs.

Fire and explosion protection is required. An example of an early warning fire alarm is CO-detection.

Applicability

Applicable in the dairy sector.

Economics

High capital costs.

Driving force for implementation

Reduced energy and water costs.

Example plants

A large dairy making powdered milk in Germany.

Reference literature

[39, Verband der Deutschen Milchwirtschaft (German Dairy Association), 2001]

4.7.5.9 Use of an aseptic packaging system not requiring an aseptic chamber

Description

An example dairy installation (also described in Section 4.7.5.4) receives 450000 litres of milk, at a quality complying with the Directive 92/46/EEC. The installation requires its suppliers to use mechanical milking, to have proper refrigeration capacity and to apply HACCP.

UHT milk processing is applied, followed by homogenisation and online aseptic packaging. High efficiency tubular type heat-exchangers are used in this process. The brick-shaped packages are made of paper-based laminated material, which includes several layers of plastic film and aluminum foil. The packages are formed from a continuous strip of the material, which enters the filling machinery through a hydrogen peroxide sterilising bath. Subsequently, the strip is formed into a tube around the sterilised product feed line, and appropriate longitudinal and cross seams are made by heat-sealing the plastic inner surfaces as the package is filled. This continuous aseptic packaging system does not require an aseptic chamber.

The packaging process is shown schematically in Figure 4.67. The numbers in the unit operations in Figure 4.67 follow after those in Figure 4.65.

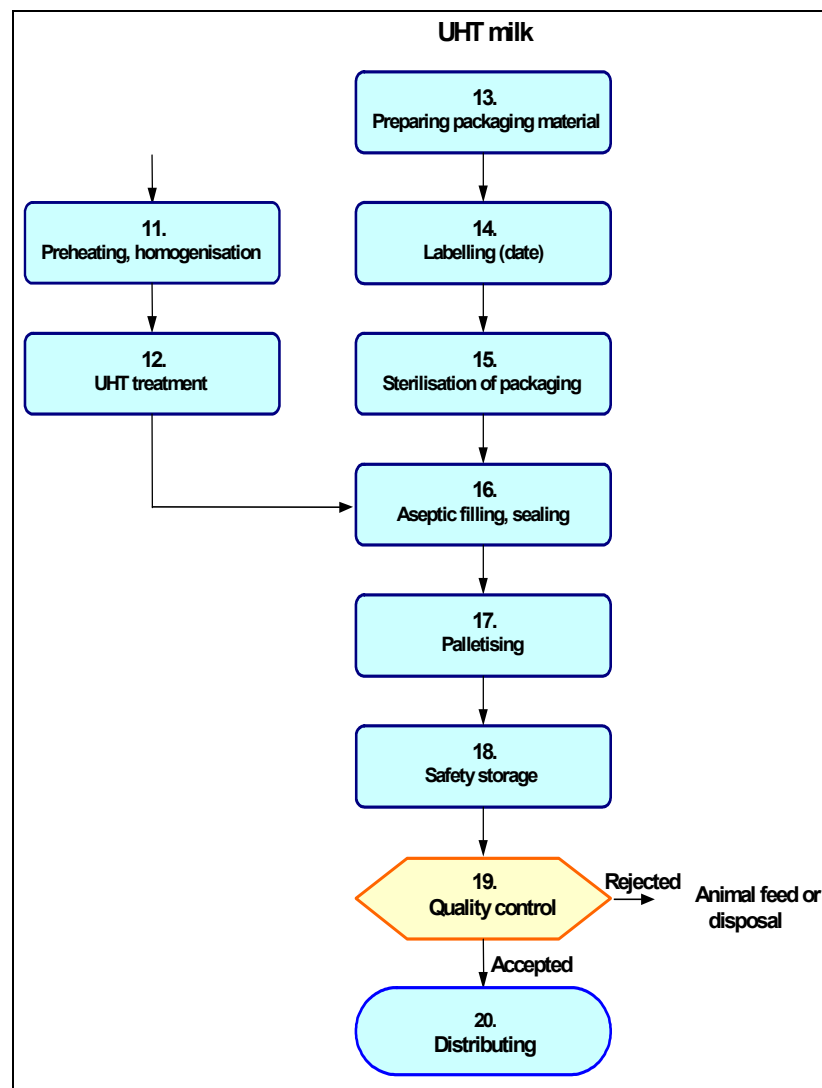

Figure 4.67: Aseptic packaging of UHT milk, without an aseptic chamber

Achieved environmental benefits

Energy saving in heat treatment, lower packaging waste and lower milk losses.

Operational data

The spoilage, when this system is used, is reportedly below 0.5 %.

Applicability

Applicable in new and existing installations.

Economics

Investment costs are high.

Driving force for implementation

Reduced costs for energy and water.

Example plants

At least one dairy in Hungary.

Reference literature

[148, Sole, 2003]

4.7.5.10 Online detection of transition points between the product and the water phases

Description

Pipelines are usually filled with water before start-up. Water is then pushed out by the product through a drain valve. Traditionally, drain valves were closed manually according to visual observation or automatically by counting the time needed to fill the pipeline with the product. To achieve an accurate detection of transition points between the product and the water phases, online methods are now used for fully automated production lines, e.g. measuring the volume using flow (see Section 4.1.8.4) or density transmitters; measuring the density using conductivity transmitters (see Section 4.1.8.5.2) and using optical sensors (see Section 4.1.8.5.3) to differentiate water from the product.

These techniques can be used to recover product from CIP initial rinses, HTST start-up, shut-down and change-over and from the rinsing of other equipment and pipework.

Achieved environmental benefits

Reduced waste water pollution.

Operational data

Optical sensors are reportedly the most reliable, accurate and have a shorter response time compared to the other online methods. It is reported that when using optical sensors, the amount of rinse-water containing milk that goes to the WWTP can be reduced to a couple of litres per start-up. In addition, product losses can be reduced by 50 %. In filling lines used for liquid milk products, the use of these sensors reduced the amount of change-over mixtures by 30 – 40 %.

In an example installation using conductivity transmitters, the BOD load in the waste water decreased by 30 %. Regular calibration of the density transmitter is needed.

Applicability

Transmitters and sensors can be installed both in new and existing installations. Minor modifications in the process control system are needed to install them.

Conductivity transmitters are mostly used in CIP centres for detecting the transition points between water and detergent solutions, but they can also be used for production lines. Optical online sensors are commercially available. They can be used for the standardisation of the fat content of milk.

Economics

The price of an optical sensor is about EUR 2700 (2001). The cost of implementing process control includes, not only the price of sensors, but also other associated hardware and software, e.g. transmitters and display equipment.

Driving force for implementation

Product losses and waste water treatment costs are reduced.

Example plants

An example dairy in Finland has installed 61 online optical sensors in its process lines. Conductivity transmitters and flow transmitters are widely used in Nordic countries.

Reference literature

[42, Nordic Council of Ministers, et al., 2001]

4.7.5.11 Provision of in-line storage tanks to minimise product recirculation in pasteurisers

Description

A production line can be designed in such a way that the capacities of the individual components are optimised with respect to the others, in order to prevent product build-up or shortage in some parts of the line. Later changes in the production line or in the filling schedule might, however, disturb the balance causing interruptions in the continuous operation.

For instance, if the capacity of the in-line storage tanks is too small compared to the output of the pasteuriser in a pasteurisation line, the milk has to be recirculated in the pasteuriser several times during the day. This consumes energy and harms the quality of the product and is regulated by Council Directive 92/46/EEC [191, EC, 1992]. Furthermore, longer interruptions increase the frequency of cleaning the pasteuriser.

Interruptions in the line and recirculation of the milk in the pasteuriser can be avoided or minimised by adapting the size/number of in-line storage tanks to the output of the pasteuriser and by optimising the product change-overs.

Achieved environmental benefits

Energy is saved mainly in the form of reduced cooling water consumption. The total consumption of electrical power required for the running of pumps, homogeniser and centrifugal separator also decreases, as the total processing time becomes shorter. Reductions in cleaning frequencies reduce the consumption of energy, water and chemicals. The negative effect of excess heat treatment on the quality of the product is also reduced.

Operational data

In an example dairy, supplying a pasteurisation line with in-line storage tanks before filling, together with automation of the product change-overs, resulted in a 30 % reduction of the processing time. The annual energy savings in this dairy amounted to 250 MWh in electrical energy and 230 MWh in thermal energy. The estimated payback period is 4.5 years.

Applicability

Applicable in dairies. Lack of space might be a constraint in existing installations.

Economics

Lower operational costs, e.g. reduced energy and water consumption.

Driving force for implementation

This solution offers improved flexibility, better quality and lower operational costs.

Reference literature

[42, Nordic Council of Ministers, et al., 2001]

4.7.5.12 Just-in-time mixing “component filling”

Description

A filling machine concept called “component filling” enables milk products to be diversified as late as possible, preferably immediately prior to filling. In this machine there are two pipelines, one with skimmed milk and the other with milk of a standardised fat content. These are mixed at the filling machine to the ratio required for each particular product. For example, a dairy might produce three types of milk, with three different fat contents and these would be achieved by changing the amount supplied from the two pipelines. Losses of product and packaging materials caused by change-overs in production can be eliminated using this technique. Component filling also reduces the need for in-line storage tanks and the corresponding cleaning requirements.

Achieved environmental benefits

Reduced product and packaging waste. Reduced water consumption, e.g. for cleaning and reduced waste water pollution.

Operational data

Normally, 75 – 100 litres of milk can easily be lost because of the change-over of production in a traditional filling operation.

Applicability

Applicable to new and existing milk production installations. Modification of the pipework and an automation system is needed before installing the machine in an existing installation.

Economics

The price of a new component filling machine with a filling capacity of 12000 – 12500 packs/h is approximately EUR 1 million (2001), not including any process modification that may be needed. In many cases, one component filling machine may replace several ordinary fillers.

Driving forces for implementation

Flexibility of the production is increased, allowing a more consumer-driven approach. The faster the product moves through the supply chain, the need for cold storage space is reduced.

Example plants

There are a total of three component filling machines in the Nordic countries, including one in Finland.

Reference literature

[42, Nordic Council of Ministers, et al., 2001, 199, Finland, 2003]

4.7.5.13 Butter

4.7.5.13.1 Minimisation of losses during buttermaking

Description

Due to the high viscosity of cream, the cream heater may be rinsed with with skimmed milk, which is then retained and used, before the cleaning. This reduces fat losses. Buttermilk which results as a by-product can be used as a product and not disposed of, e.g. into the waste water. These savings may be used, e.g. as a base for low fat spreads.

Achieved environmental benefits

Reduced waste.

Applicability

Applicable in butter and cream making.

Driving force for implementation

Reduced waste and increased product yield.

4.7.5.14 Cheese

4.7.5.14.1 Using ultrafiltration (UF) for protein standardisation of cheese milk

Description

Ultrafiltration (UF) can be used for protein standardisation of cheese milk. The milk flows under pressure over a membrane that withholds the protein molecules, thus increasing the protein content of the retentate. The membrane pore size ranges from about 10 to 100 nm.

As using UF leads to an increase in the cheese yield per processed milk unit, the generated quantity of whey is smaller compared to traditional standardisation. Furthermore, even when UF requires additional electrical power, thermal energy and water compared to traditional standardisation, in large scale production, the increase in cheese yield compensates for the increased consumption of energy and water.

The permeate from the UF unit is further treated by RO. The RO water, which is of drinking water quality, can be used for cleaning purposes.

Achieved environmental benefits

Reduced energy and water consumption, whey and waste water in comparison with traditional standardisation.

Cross-media effects

The membranes need to be cleaned. As chemicals are used for this, the filtration circle has to be well rinsed with large amounts of water. Disposal of used membranes.

Operational data

The UF unit in a Danish dairy consists of 10 spiral wound modules equipped with polymer membranes, four pumps and the necessary flow transmitters and regulating valves. The filtration capacity is 65000 l/h. The protein content of the milk is standardised to 3.7 – 3.8 % by controlling the ratio between feed and permeate. Compared to the traditional standardisation method, the cheese yield is higher, i.e. about a 12 % reduction in milk volume was gained. A calculation made for a 25000 t/yr yellow cheese production, led to the estimated savings in water and energy shown in Table 4.105.

Electrical energy	473 MWh/yr	19 kWh/t cheese
Thermal energy	1235 MWh/yr	49 kWh/t cheese
Water	7500 m ³ /yr	300 l/t cheese

Table 4.105: Savings in water and energy consumption in a dairy using UF for protein standardisation

UF-membranes have a limited lifetime of 1 – 3 years due to application. After use they are incinerated or sent for landfill.

Applicability

UF can be applied to both skimmed milk and whey. UF units can be installed in new and existing installations because of their low space requirements.

Economics

The investment cost is high. Payback periods are acceptable only if the capacity is large enough. For example, the investment cost in the example Danish dairy is estimated to be EUR 430000 and the payback period 5.9 years.

Driving force for implementation

Cheese of homogenous quality can be produced using this technique. It also offers a larger flexibility for making different types of cheese.

Example plants

A dairy in Denmark.

Reference literature

[42, Nordic Council of Ministers, et al., 2001]

4.7.5.14.2 Reduction of fat and cheese fines in wheyDescription

To accomplish the reduction of fat and cheese fines in whey, first, during the processing of the curd, the highest possible yield of fat and protein is achieved and after, the whey is screened to collect remaining fines.

Achieved environmental benefits

Reduced product loss. If whey is allowed to enter the WWTP, the pollutant load is lower, but see Section 4.7.5.14.3 for minimising this.

Applicability

Applicable in cheese manufacturing installations.

Economics

Optimisation of production costs. Reduced waste water treatments costs.

Driving force for implementation

Reduced product losses.

Reference literature

[134, AWARENET, 2002]

4.7.5.14.3 Minimise the production of acid whey and its discharge to the WWTPDescription

In cheese manufacturing, about 90 % of the milk used ends up as whey. For acid type cheeses, lactic acid mother cultures are grown on media and then bulk cultures are propagated and added to milk to make cheese. Acid whey is separated after curd formation. If acid whey is discharged to a WWTP, it may cause low pH levels. To prevent this, spillages are avoided by draining the top or platform of the salting vats. In addition, whey can be processed quickly so less acid whey is produced due to lactic acid formation.

Achieved environmental benefits

Reduced waste water pollution.

Applicability

Applied in the manufacture of acid type cheeses, e.g. cottage cheese, quark and mozzarella.

Economics

Reduced waste water treatments costs.

Reference literature

[13, Environment Agency of England and Wales, 2000]

4.7.5.14.4 Recovery and use of wheyDescription

In cheese manufacturing, about 90 % of the milk used ends up as whey. Sweet whey is produced during the making of rennet type hard cheeses, e.g. cheddar or Swiss cheese. Salt whey is produced after salt has been added to the curd to remove additional liquid. Sweet whey is collected and re-used in the process or in other processes to make by-products, e.g. for protein recovery, as animal feed, in the production of mitzithra cheese, as a food supplement and as baby food. Even when salt whey cannot be re-used in the process without the removal of the salt (see Section 4.7.5.14.6), it can either be collected as it is, or concentrated by evaporation and used as animal feed.

Achieved environmental benefits

Reduced waste water pollution. Reduced waste, i.e. whey is re-used.

Operational data

The characteristics of a typical waste water from cheese manufacturing with and without whey recovery are shown in Table 4.106.

Parameter	Installation with whey recovery	Installation without whey recovery
	mg/l	
BOD ₅	2397	5312
COD	5312	20559
Fats	96	463
N _{total}	90	159
P _{total}	26	21

Table 4.106: Composition of cheese manufacturing waste water

Applicability

Applicable in cheese manufacturing installations.

Economics

Reduced waste water treatments costs.

Reference literature

[42, Nordic Council of Ministers, et al., 2001, 134, AWARENET, 2002]

4.7.5.14.5 Recovery of salt whey by evaporationDescription

In cheese manufacturing, about 90 % of the milk used ends up as whey. Salt whey is produced after salt has been added to the curd to remove additional liquid. Salt whey can be re-used in the process or used as animal feed either directly or after drying by evaporation. The condensed water may be used for cleaning.

Achieved environmental benefits

Reduced waste, e.g. whey is used. Reduced waste water pollution.

Cross-media effects

Energy consumption.

Applicability

Applicable in cheese manufacturing installations.

Reference literature

[134, AWARENET, 2002]

4.7.5.14.6 Recovery of whey by removal of salt using RODescription

In cheese manufacturing, about 90 % of the milk used ends up as whey. Salt whey is produced after salt has been added to the curd to remove additional liquid. Salt whey can be re-used in the process, along with sweet whey (see Section 4.7.5.14.4), only after the salt is removed by RO.

Achieved environmental benefits

Reduced waste, e.g. whey is re-used. Reduced waste water pollution.

Cross-media effects

The RO permeate is highly saline.

Applicability

Applicable in cheese manufacturing installations.

Economics

High costs.

Reference literature

[13, Environment Agency of England and Wales, 2000]

4.7.5.14.7 Utilisation of heat from warm whey for preheating cheese milkDescription

The incoming milk is preheated with warm whey, which is simultaneously strained off from another vat. Heat-exchangers and tanks are needed for circulating the water. Savings in energy for heating the incoming milk and cooling energy for the processed whey are achieved.

Achieved environmental benefits

Reduced energy consumption.

Operational data

In a Danish example dairy, the cheese milk is heated from 12 to 32 °C with heat from a closed system with circulating water at 34.5 °C. The temperature of the water decreases to 13 °C and it is subsequently reheated in the cooling section of the whey pasteuriser, where the whey is cooled from 36 to 14.5 °C. In addition to the plate heat-exchangers, two buffer tanks of 150 m³ were installed for the circulating water. Savings, assuming 250 million kg/yr whey, were estimated to be 1200 MWh/yr electrical energy, 6065 MWh/yr heat energy and 4200 m³/yr water.

Applicability

Applicable in new and existing installations. In existing installations, the lack of sufficient space can be a constraint.

Economics

In the Danish example dairy, the cost estimation was made, but this was for the whole whey processing; including an RO unit as well as the heat treatment and heat recovery. The total costs amounted to about EUR 1.6 million with a payback of 3.8 years.

Driving force for implementation

Reduced energy costs.

Example plants

A dairy in Denmark.

Reference literature

[42, Nordic Council of Ministers, et al., 2001]

4.7.5.14.8 High temperature cheese ripening with later humidification and ionisation of the ventilation air

Description

In cheese manufacturing, the temperature of the air is increased to shorten ripening times. This leads to a reduction in the demand for storage facilities, cooling power and ventilation energy. As a higher temperature increases the risk of dehydrating the cheese and of contamination by mould, the ventilation air is humidified and cleaned by a discharge tube which ionises the air which is passed through ventilation ducts. As ions in the ventilation air react with dust particles, micro-organisms and viruses, the air is effectively cleared of these sources of contamination.

Achieved environmental benefits

Reduced energy consumption.

Operational data

In an example cheese installation, a project was started in January 1994 to reduce energy consumption. Before the project, the manufacturer stored cheese at 12 °C to allow ripening to take place. The temperature was increased to 15 °C. The ventilation air was humidified and cleaned of dust and micro-organisms by ionisation prior to entering the warehouse. The new equipment allows the air temperature to rise to 16 °C at 85 % relative humidity. Energy savings amounting to 272000 kWh/yr, or 85000 m³/yr of natural gas, were reported. A shortening of the ripening time by 50 %, an improvement of the product quality and a reduction of the consumption of plastics and fungicidal agents were also reported.

Applicability

Applicable in cheese manufacturing installations. High temperature ripening is limited due to the desired taste, product quality and stability.

Economics

In the example installation, considerable savings were achieved in labour costs, maintenance and in the use of materials for cleaning the ventilation system. The payback period is around two years.

Driving force for implementation

Reduction in energy costs.

Example plants

A cheese warehouse in the Netherlands.

Reference literature

[143, CADDET Energy Efficiency, 1997, 222, CIAA-Federalimentare, 2003, 239, CIAA-EDA, 2003]

4.7.5.15 Ice-cream**4.7.5.15.1 Heat recovery from pasteurisation in ice-cream production**Description

Heat and water can be recovered from the ice-cream pasteurisation process. The ice-cream mix enters the pasteuriser at a temperature of 60 °C and is then heated to 85 °C, followed by cooling to 4 °C prior to ageing. The cooling phase consists of two steps. In the first step, the ice-cream is cooled to 70 °C by regenerative heat-exchange and in the second step, cooling water is used for further cooling to approximately 20 °C. The final temperature of 4 °C is achieved by cooling with ice-water.

The heat released to the water, from the ice-cream mix in the second cooling step can preheat the water for various purposes, mainly for cleaning operations. This requires a number of storage tanks for the hot water.

Achieved environmental benefits

Reduced energy and water consumption.

Cross-media effects

The hygiene quality of the water has to be checked as leaks in the plates of the heat-exchanger can result in contamination of the water with the product.

Operational data

In an example ice-cream installation, the heat from the second cooling step is used for preheating approximately 25 % of the total amount of water used in the installation. The heat recovery yields hot water at approximately 70 °C. The average inlet temperature of the cooling water is 10 °C and the corresponding quantity of heat recovered is 7600 GJ/yr, which represents approximately 14 % of the energy consumption of the installation. The hot water is used for CIP and the quantity of water saved is approximately 1000 l/t of ice-cream mix produced.

Applicability

Applicable in new and existing installations. Space is needed for water storage tanks.

Economics

Reduced costs for energy and water.

Example plants

At least one ice-cream installation in Sweden.

Reference literature

[42, Nordic Council of Ministers, et al., 2001]

4.7.5.16 Re-use and recycling of water for cleaning in dairies

For further information about cleaning, see Section 4.3.

Description

Cooling water, condensates generated in evaporation and drying operations, permeates generated in membrane separation processes and cleaning water can be re-used in dairy installations.

In some cases, cross-contamination risks will need to be considered when re-using water, for instance between starter batches in cheesemaking.

Avoiding an unnecessary contamination of condensate maximises the potential for water re-use, sometimes without any treatment, depending on the intended use. The cleanest condensate may be suitable for use as boiler feed-water. Table 4.107 shows some water re-use opportunities in dairies.

Use	CIP used cleaning solution	CIP final rinse	Condensate	Permeate from RO installation
Cleaning the outsides of vehicles	1	1	1	1
Crate cleaning	2	1	1	1
Manual cleaning of the outside of equipment	3	3	1	1
CIP pre-rinse	2	1	1	1
CIP main cleaning supply	3	3	3	1
CIP final rinse	NO	3	3	3
Water purge of product lines	NO	3	3	3
1. Direct re-use 2. Re-use after screening of solids 3. Re-use after advanced treatment, e.g. membrane separation and/or disinfection				

Table 4.107: Water re-use opportunities at dairies

Achieved environmental benefits

Reduced water consumption and waste water generation, and reduced contamination of waste water. Valuable by-products can be produced and waste generation reduced.

Operational data

It is reported that an example dairy in the UK processing 2500 tonnes of milk per day recovers all condensate from its evaporators and then treats it by RO and disinfects it to provide cleaning water. The amount of water evaporated is of the order of 2000 m³/d. Approximately 10 % of incoming flow is rejected and sent to waste water treatment. The company aims to have zero drinking water input to the site. Before treatment, the warm condensate is used to initially preheat incoming milk.

The use of membrane techniques in whey processing enables valuable by-products, whey protein concentrate and lactose concentrate to be produced. When an RO stage is included, demineralised water is produced which is suitable for use as boiler feed-water or membrane CIP. Figure 4.68 shows a flow diagram of a membrane processing system in cheese manufacturing.

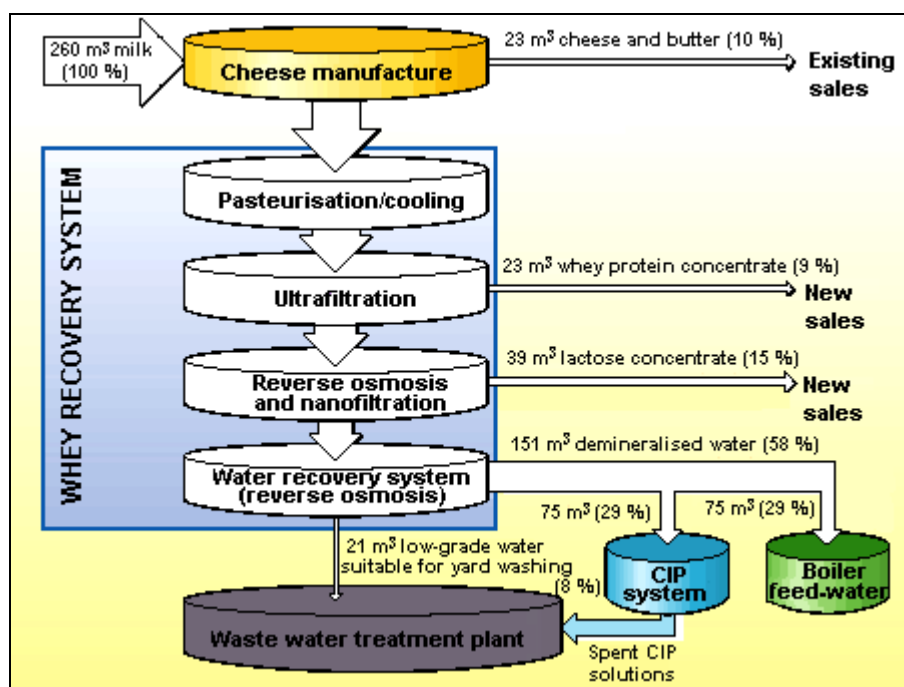

Figure 4.68: Flow diagram of the membrane processing system

Applicability

Applicable in all dairies.

Driving force for implementation

Reduced need to purchase drinking water and the production of valuable by-products.

Example plants

At least one milk producing dairy in the UK uses treated evaporator condensate for cleaning. At least one cheesemaking dairy in the UK produces demineralised water from RO and uses it as boiler feed-water or membrane CIP.

Reference literature

[52, Envirowise (UK), 2000, 94, Environment Agency of England and Wales, 2002]

4.7.5.17 Re-using warm cooling water for cleaning

Description

Cleaning is the most water consuming process in the dairy sector and large savings are possible in this area. Many dairy operations involve cooling with cold water in heat-exchangers, which results in warm cooling water. Usually the warm cooling water from the process is re-used for cleaning purposes, mainly for cleaning milk tankers. Warm cooling water can generally be used for the intra-plant cleaning, regardless of its temperature. In the dairy industry, water above 50 °C can be re-used for the cleaning of milk tankers or for the manual cleaning or CIP of equipment.

Achieved environmental benefits

The water and energy savings depend on the amount of re-usable warm cooling water used and its temperature.

Operational data

When using this water for cleaning surfaces which may be in contact with products, the hygiene of the warm cooling water is of the utmost importance. The quality is generally good, provided that the water does not contain any traces of product from leaks in the equipment. Normally, it is stored for some time in an insulated buffer tank awaiting further use. One way of minimising any hygiene risks is to treat the water with UV radiation. The use of UV radiation and other techniques are described in Sections 4.5.4.8, 4.5.4.8.1 and 4.5.4.8.2.

In an example Nordic dairy, a reduction in water consumption of about 2 % has been reported.

Applicability

Re-using cooling water can be applied in new and existing installations. The space requirements for the warm water storage tanks may be a constraint in existing installations. Its use also depends upon what chemicals, if any, were previously used in the cleaning.

Economics

The costs are associated with the installation of the equipment required for re-using warm cooling water for cleaning, i.e. a storage tank and pipework for collection and distribution of the water.

Driving forces for implementation

Reduces costs for water and energy.

Example plants

Two dairies, one in Sweden and the other in Finland.

Reference literature

[42, Nordic Council of Ministers, et al., 2001]

4.7.5.18 In-process environmental management at a dairy – a case study

Description

The example dairy processes 1.2 million litres of milk per week, producing around 200 tonnes of yoghurt and 15 tonnes of cottage cheese per week. The balance of the milk is used for pasteurised and UHT milk and cream production. Waste water is discharged to a MWWTP.

The installation operator decided to upgrade the existing on-site WWTP, which comprised sedimentation of a proportion of the waste water, prior to discharge to sea. The estimated waste water treatment costs were halved by introducing and operating in-process techniques for minimising waste water generation and contamination.

All the staff were involved in completing the following actions:

- for cottage cheese, the whey was already collected for animal feed (see Section 4.7.5.14.4), but the number of tanks installed was increased to allow for the collection of curd wash-water and yoghurt residues, also each tank was fitted with high level alarms (see Section 4.1.8.3)
- yoghurt pipelines were modified by incorporating 135° bends to improve drainage (see Section 4.1.3.1)
- drainage times on emptying yoghurt vats were increased by 5 minutes
- burst rinsing was introduced for yoghurt vats, with all rinsings collected for animal feed (see Section 4.1.7.7)
- a requirement to collect all the drainings of yoghurt and fruit throughout the dairy, for use as animal feed, was more rigidly enforced (see Sections 4.1.7.6 and 4.1.7.7).

Achieved environmental benefits

Reduced waste water volume and pollution, e.g. COD.

Operational data

The MWWTP set consent standards of 1130 kg COD/d and a volume consent of 450 m³/d, both of which were exceeded frequently. Average COD discharges were reduced to 450 kg/d and volumes were brought within the consent limits to around 420 m³/d.

Economics

The waste water treatment charges were EUR 125000/yr instead of the expected EUR 500000/yr with very little investment cost.

Reference literature

[1, CIAA, 2002]

4.7.6 Starch

4.7.6.1 Countercurrent water use/re-use in starch washing

Description

Countercurrent flow is a basic operation used in food and chemical engineering and means that two streams are running through the same space, but in opposite directions.

In the FDM sector, countercurrent flow is commonly applied by using drinking water only at the end of the production line for treating the end-product, i.e. usually the cleanest part of the process. The water from this step is relatively clean and can be re-used in another process step, for which the water is sufficiently clean, usually earlier in the process, i.e. the water flows countercurrently to the product, so that the final product only comes into contact with fresh drinking water.

Countercurrents are used for washing operations.

The advantage of a countercurrent flow is that for a given product quality the required amount of water is reduced to the lowest possible in principle and consequently the amount of waste water generated is minimised.

Achieved environmental benefits

Reduces water consumption and consequently reduced waste water generation.

Operational data

The technique may be operated either continuously or in batches.

It is common practice to wash raw starch slurry, using a countercurrent flow, before it is dewatered and dried to produce refined starch. The starch is washed with drinking water, using a countercurrent flow, in a series of 4 – 6 centrifuges. At one end, raw starch is the input and process water is the output and, at the other end, refined starch is the output and fresh drinking water is the input. The countercurrent system uses much less water than either repeated washing with fresh drinking water or adding fresh drinking water at each stage.

Applicability

Applicable when several washing stages are required, which need progressively cleaner water.

Driving force for implementation

Reduced water consumption.

Example plants

Numerous installations producing starch from maize, wheat or potatoes.

Reference literature

[182, Germany, 2003, 208, CIAA-AAC-UFE, 2003]

4.7.7 Sugar

4.7.7.1 Drying of sugar beet pulp

After extracting sugar from cossettes, the beet pulp is pressed. If it is pressed to give a solids content of 12 – 17 %, it is called wet pulp. If it is pressed to a solids content of 18 – 34 %, it is called pressed pulp. Both wet and pressed pulp may be sold as animal feed, e.g. sweet feed for cattle. This is normally carried out after drying the pulp.

Dried pulp can be obtained by drying the pulp to a solids content of 86 – 92 %. About 5.6 kg dried pulp with a solids content of 90 % can be produced out of 100 kg of sugar beet. If 1 – 3 % of molasses, based on the weight of the pulp, is added before drying, molassed dried pulp with a varying sugar content, e.g. 9 – 30 %, is obtained. Apart from the sugar content, the concentrations of HCl insoluble substances, calcium, and ash are controlled in each country according to feed regulations.

Pulp drying is generally carried out by convection drying, e.g. drying with air, flue-gas or steam. When drying with air or flue-gas, the drying gas is heated and then brought into contact with the pulp. Warm, dry air can take up water vapour until it is saturated. Heat and substance transfer take place simultaneously in the drying process. In the first drying period, the drying rate remains practically constant. During this period, unbound liquid is vaporised from the surface of the solid and carried away by the drying agent. When the moisture content is reduced below a critical value, the surface of the solid dries out, and further evaporation takes place in the interior of the porous solid. The drying rate decreases with decreasing moisture content. This is called the second drying period. The residual moisture in the solid is bound to it by sorption. The drying rate decreases rapidly with a decreasing moisture content and tends to zero as the hygroscopic equilibrium moisture content is approached. The regime between the maximum hygroscopic moisture content and the equilibrium value is designated as the third drying period. The lower the residual moisture content of the pulp is supposed to be, the lower is the necessary residual moisture level in the drying gas.

When drying with steam, the requirements for the drying gas are similar. High dry matter levels in the material being dried require high residual superheating of the steam, corresponding to the low relative humidity in the air.

Beet pulp drying at sugar processing installations is described in Sections 4.7.7.1.1 - 4.7.7.1.5. The decision about whether to dry sugar beet pulp depends on factors such as whether there is a nearby outlet for the wet pulp, e.g. for animal feed. The storage of wet pulp can cause odour problems and the transport of wet pulp is expensive. In several European countries, e.g. France, beet pulp may be dried in installations which usually belong to farmers and are not directly connected to the sugar production process.

4.7.7.1.1 Low temperature drying of sugar beet pulp

Description

Low temperature drying (LTD) can be used as a preliminary step before high temperature drying (HTD), in the two-stage drying of sugar beet pulp. In LTD of sugar beet pulp, large quantities of drying gas, e.g. air or flue-gas, with an inlet temperature of about 50 °C, are saturated. The outlet temperature is about 25 – 30 °C. Belt driers are used for LTD.

Achieved environmental benefits

Drying the pulp produces animal feed that can be stored for a longer time than moist feed.

Cross-media effects

Energy is consumed. Dust and odour are emitted to air. NO_x is emitted when flue-gas is used. LTD uses about 30 times more gas volume than HTD (see Section 4.7.7.1.2).

Operational data

Table 4.108 shows examples of the air states for LTD and HTD of sugar beet pulp.

Parameters of the drying gas		LTD			HTD		
		In	Out	Δ	In	Out	Δ
Temperature	°C	50	25		750	102	
Relative humidity of the gas	%	9.0	88.6		*	33.1	
Water vapour load	kg/kg	0.0070	0.0181	0.0111	0.0366	0.3508	0.3142
Enthalpy of moist air in relation to dry air	kJ/kg	68.8	71.1		983.2	1049.8	
Enthalpy of moist air in relation to dry air	kWh/kg	0.019	0.020		0.273	0.292	
Air/water evaporated ratio	kg/kg	$1/\Delta y = 0.0111^{-1} = 89.9$			$1/\Delta y = 0.3142^{-1} = 3.2$		
* Not defined because critical temperature exceeded Δy : increase of the fuction							

Table 4.108: Characteristic LTD and HTD of sugar beet pulp

Applicability

Applicable for drying pulp in the sugar sector.

Driving force for implementation

Drying the pulp produces animal feed that can be stored for a longer time than moist feed.

Example plants

Used in two German sugar installations, in combination with HTD.

Reference literature

[65, Germany, 2002]

4.7.7.1.2 High temperature drying of sugar beet pulp

Description

In high temperature drying (HTD), the drying gas, e.g. air or flue-gas, is heated to a temperature of up to 950 °C by direct firing and then cooled to approximately 100 °C by evaporation of water from the pulp in the drier. Co-currently operated rotary drum driers with preceding firing are used for drying pressed pulp.

Achieved environmental benefits

Drying the pulp produces animal feed that can be stored for a longer time than moist feed.

Cross-media effects

Energy is consumed. Waste water is produced. Dust and odour are emitted to air. NO_x, CO and organic compounds are emitted when flue-gas is used.

Operational data

See also Section 4.7.7.1.5.

The amount of heat required for the evaporation of 1 kg of water depends on the temperature gradient between the inlet and outlet of the drum. The higher the combustion gas temperature at the inlet of the drum, the greater is the thermal efficiency of the equipment. Typically, drying at temperatures of up to 750 °C is considered to be HTD, except in the UK, where drying is carried out at 950 °C. It is reported that this gives a 15 – 18 % benefit in energy efficiency over drying at 750 °C. However, excessively high entrance temperatures may lead to strong scaling of the internal parts and burning of the material to be dried. For inlet temperatures of 600 °C, approximately 0.972 kWh (3500 kJ) per kilogram of water to be evaporated are used. In the drums, 150 – 180 kg of water evaporates per hour per cubic metre of drum contents. At the end of the process, the temperature of the drying gas is around 100 °C. The material being dried has a temperature of 60 to 70 °C during the drying process.

The drying gas used can be a mixture of firing gas which is formed during the combustion of fuel in the drier firing system; recycled drier flue-gas; boiler flue-gas from steam generation and a small proportion of ambient air which is drawn into the drum due to the design of the system. Cooling air is used in exceptional cases only. The flue-gas from the steam generation is, apart from the molasses-treated pulp, the sole connection between the drying unit and the rest of the sugar installation.

In the drying process, the firing gas accounts for about 25 % of the stream mass and about 75 % of the stream energy. The steam generator flue-gas supplies about 70 % of the stream mass to the flue-gases and about 25 % of the stream energy for the drying gases.

When flue-gas is used for drying, NO_x is released. The level of NO_x within the flue-gas is a function of the type of fuel, the burner type, primary, secondary and tertiary air split and the location of any recycled exhaust gases used. For example, in five German sugar production installations using natural gas, the average NO_x content was about 70 mg/Nm^3 in the exhaust gas and in 12 sugar installations using heavy fuel, it was about 270 mg/Nm^3 . The emission of organic compounds is about $50 - 600 \text{ mg/Nm}^3$ and the emission of CO is about $210 - 1050 \text{ mg/Nm}^3$. The dust concentration in the air after cyclone treatment of the five sugar installations using natural gas was about 35 mg/Nm^3 , while two factories using coal for their boiler and heavy oil/natural gas for the drying, had an average dust concentration of about 82 mg/Nm^3 . The emissions of $50 - 60 \text{ mg/Nm}^3$ wet dust and 0.08 kg TOC/t of sliced beet have been reported from Germany, measured under reference conditions 12 vol-% O_2 content of air. The dust in the exhaust air of a drier also depends on the moisture content of the dried pulp. A solid content above 91 % may lead to higher dust in the air. The solid content needs to be higher than 86 % because a higher moisture content can reduce the biological stability of the pulp.

The major environmental issue is the energy consumption. The energy consumption may be reduced by reducing the initial water content of the beet pulp. When the dry solid content of the pulp after pressing is 25 %, 2.6 tonnes of water per tonne dried pulp has to be evaporated in the drying process to achieve a 90 % solids content. When the pressed or pre-dried pulp has 35 % solids, only 1.6 tonnes of water needs to be evaporated to produce one tonne of dried pulp. With lower amounts of water to be evaporated, lower amounts of air or flue-gas are needed and consequently lower amounts of condensed water are generated. In consequence, less air and waste needs to be treated.

Table 4.108 shows examples of the air states for LTD and HTD.

Applicability

HTD is the most commonly used technique in Europe. It is applicable for drying pulp in the sugar sector. This technique can be operated independently of the method of operation of the sugar installation and the steam generators.

Economics

See also Section 4.7.7.1.5.

Steam drying with FBDs and two-stage drying have practically the same NPV, while HTD is cheaper by about 6 %. However, if the calculations are done with a longer operational life, i.e. 18 years, for the driers and the gas turbine, the NPV of steam drying with FBDs is the lowest, e.g. lowest cost.

Driving force for implementation

The equipment and the process constitute a robust and reliable technology. A wealth of experience exists with these drying systems and the process itself. Drying the pulp produces animal feed that can be stored for a longer time than moist feed.

Example plants

Used in most of the sugar sector (see Section 4.7.7.1.5).

Reference literature

[65, Germany, 2002, 87, Ullmann, 2001]

4.7.7.1.3 Two-stage drying of sugar beet pulp

Description

For molasses-treated pulp drying, the first step is an LTD of the pulp using a belt drier (see Section 4.7.7.1.1). Molasses are mixed to the pulp, and then the whole mixture is dried with HTD in a rotary drum drier (see Section 4.7.7.1.2). LTD is used as a first step to make use of the lower energy heat from the HTD step and from the sugar production processes.

Achieved environmental benefits

Reduced energy consumption and air pollution compared to HTD. Drying the pulp produces animal feed that can be stored for a longer time than moist feed.

Cross-media effects

Dust and odour are emitted. NO_x, CO and organic compounds are emitted when flue-gas is used. Waste water is produced.

Operational data

See also Section 4.7.7.1.5.

If two-stage drying is applied, about 30 % energy can be saved by using the vapours of the HTD step for the first step, LTD. Most belt driers operate with hot air at approximately 60 °C, which can be heated using the heat streams from the evaporation station and crystallisation unit of the sugar installation, which would otherwise be lost to the environment as waste heat.

This use of secondary energy from the sugar production process shows an advantage to beet pulp drying of carrying out sugar production and beet pulp drying at the same installation. This may be done if the heat is not re-used within the sugar production process.

The waste water produced by the condensation of the vapours created at the HTD step are either sent to a WWTP or for landspreading.

Applicability

Applicable for drying molasses-treated pulp in the sugar sector.

Economics

See also Section 4.7.7.1.5.

Steam drying with FBDs and two-stage drying have practically the same NPV, while HTD is cheaper by about 6 %. However, if the calculations are done with a longer operational life, i.e. 18 years, for the driers and the gas turbine, the NPV of steam drying with FBDs is the lowest, e.g. lowest cost.

Driving force for implementation

Drying the pulp produces animal feed that can be stored for a longer time than moist feed.

Example plants

This system exists only in two installations. One is an experimental installation and the other has a very specific configuration, e.g. it was set up as an alternative to a customary falling water circuit.

Reference literature

[65, Germany, 2002]

4.7.7.1.4 Steam drying of sugar beet pulp

Description

Drying is achieved by using superheated steam. If the steam is at 130 °C, it expands and the temperature drops to 102 – 103 °C at around 0.1 MPa by the uptake of water. If the steam is at 260 °C at around 2.6 MPa, it expands and the temperature drops to 148 °C at around 0.37 MPa. FBDs can be used in steam drying.

Achieved environmental benefits

Reduced emissions of dust and odour, compared to HTD. As flue-gas is not used, NO_x is not released. Another advantage is the lower overall energy consumption for drying compared to HTD and two-stage drying. The energy output, e.g. steam, can be re-used in the sugar extraction process. Drying the pulp produces animal feed that can be stored for a longer time than moist feed.

Cross-media effects

Waste water production. Organic compounds are also emitted to air and water.

Operational data

See also Section 4.7.7.1.5.

The closed design of steam drying has the advantage of reducing the escape of gaseous emissions, e.g. dust and odour, however the venting of gases is required to maintain heat transfer in FBDs. It is reported that the concentration of malodorous compounds in the exhaust air of FBDs is 5 – 50 times higher than in HTD. It is reported that condensers can be used to reduce odour emissions, however, this technique is not described in this document.

In the case of steam driers, the water content of the exhaust gases is normally removed by condensation. A significant amount of condensate is produced in this process. Figures for steam drying using FBDs show that about 0.6 – 0.7 tonne condensate per tonne of pressed pulp are generated with an organic load of 0.20 – 0.25 kg TOC per tonne of pressed pulp.

It is reported that due to the quantities of steam required for the steam drying of sugar beet pulp it is only viable to use this technique at installations which also refine sugar.

Applicability

Applicable for drying pulp in the sugar sector. Steam drying using FBDs with an integrated steam system can be used in new sugar installations. For existing installations it may require complete reconstruction of the energy generation and heat switching facilities. Retrofitting involves reconstructing the steam generation and electricity production sections including, e.g. revising the entire heat transfer arrangements within the installation.

Economics

See also Section 4.7.7.1.5.

Steam drying with FBDs and two-stage drying have practically the same NPV, while HTD is cheaper by about 6 %. However, if the calculations are done with a longer operational life, i.e. 18 years, for the driers and the gas turbine, the NPV of steam drying with FBDs is the lowest, e.g. lowest cost.

Driving force for implementation

Savings in costs and energy. Drying the pulp produces animal feed that can be stored for a longer time than moist feed.

Example plants

Used in six German sugar installations (see Section 4.7.7.1.5).

Reference literature

[65, Germany, 2002]

4.7.7.1.5 Comparison of steam, HTD and two-stage drying of beet pulp

Description

Three German installations are analysed. The first uses steam drying with FBDs (see Section 4.7.7.1.4). The second uses HTD with a rotating drum drier (see Section 4.7.7.1.2). The third uses a two-stage drying process (see Section 4.7.7.1.3).

The first installation applies steam drying using two FBDs. The drying unit begins with the delivery of cossettes from the pressing station. The steam supply of 25 bar comes from the boiler house turbine of the sugar installation. At the end of the drying unit, the molasses-treated cossettes are transferred to the pelletising station and vapour recovery units. The molasses treatment facilities are part of the drying unit.

At the start, the cossettes from the pressing station are fed to the FBD by means of a conveyor and metering facilities. They pass through a cellular wheel sluice and a screw conveyor to the first of 16 cells arranged around the superheater. A fan, which is the only moving part in the FBD apart from the cellular wheel sluice, blows steam, which has been superheated by the off-take steam from the steam turbine, through the perforated base plates and into the cells. This keeps the cossettes suspended and allows them to be easily transported. The evaporation of moisture from the cossettes takes place in this FBD at 3 bar with a saturated steam temperature of approximately 135 °C.

Heavy particles at the lower level pass through the open cell walls of cells 1 to 16, whereas the light particles are propelled upwards into the conical part of the FBD and pass via inclined surfaces and guide rails to cell 16. The circulated steam is directed via guide vanes into the upper part of the FBD, which takes the form of a cyclone, to separate the dust particles. These gather at the outer wall of the cyclone, where they are collected by an ejector and fed to cell 16. From cell 16 the dried material passes via a screw conveyor and sluice into a cyclone. From here the dried cossettes pass through another cellular wheel sluice into a molasses screw conveyor where the molasses is added. The cossettes are then returned to the pelletising station via a conditioning screw conveyor. The steam removed from the driers has a pressure of approximately 3 bar.

The height of the drier is approximately 18 m, 7.1 m for the lower part and 10.4 m for the upper part. The weight is 320 t. Figure 4.69 shows a scheme of an FBD used for drying sugar beet cossettes.

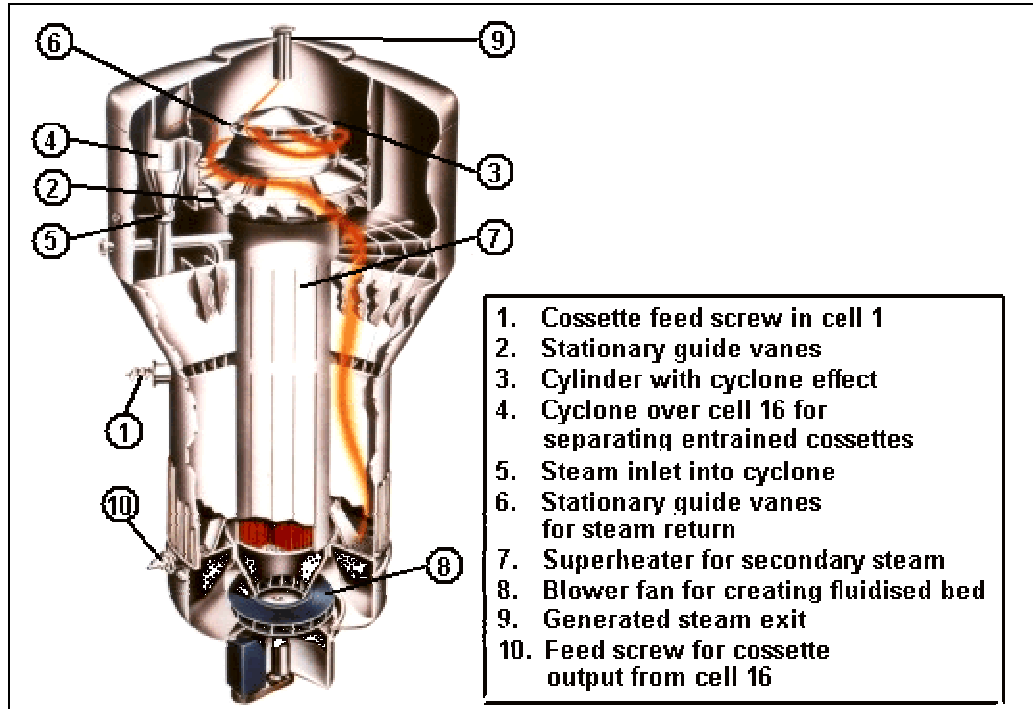

Figure 4.69: Schematic diagram of steam drying with FBDs used for drying sugar beet cossettes

About 2/3 of the total spent steam is used in the driers at a pressure of 25 bar and converted to process steam at a pressure of 3 bar. Thus the pressure or enthalpy gradient from 25 bar to 3 bar cannot, as is usual in sugar factories, be used to generate electrical energy. To meet the installation's own requirements, including the high electricity consumption of the driers, it is necessary to find a different solution from the usual counter-pressure steam-powered generating unit. One variant is to use a gas turbine which is designed for the maximum additional electricity requirements. Since a gas turbine has high exhaust gas losses, the downstream steam generator is designed as a waste heat boiler to make use of the heat energy from the gas turbine exhaust gases. The boiler has supplementary heavy fuel oil firing equipment, but due to a special firing system equipped with special burners, it succeeds in complying with the waste gas limits in the operating permit without the need for flue-gas purification equipment. Figure 4.70 shows a CHP and steam system of a sugar installation where cossettes are steam dried.

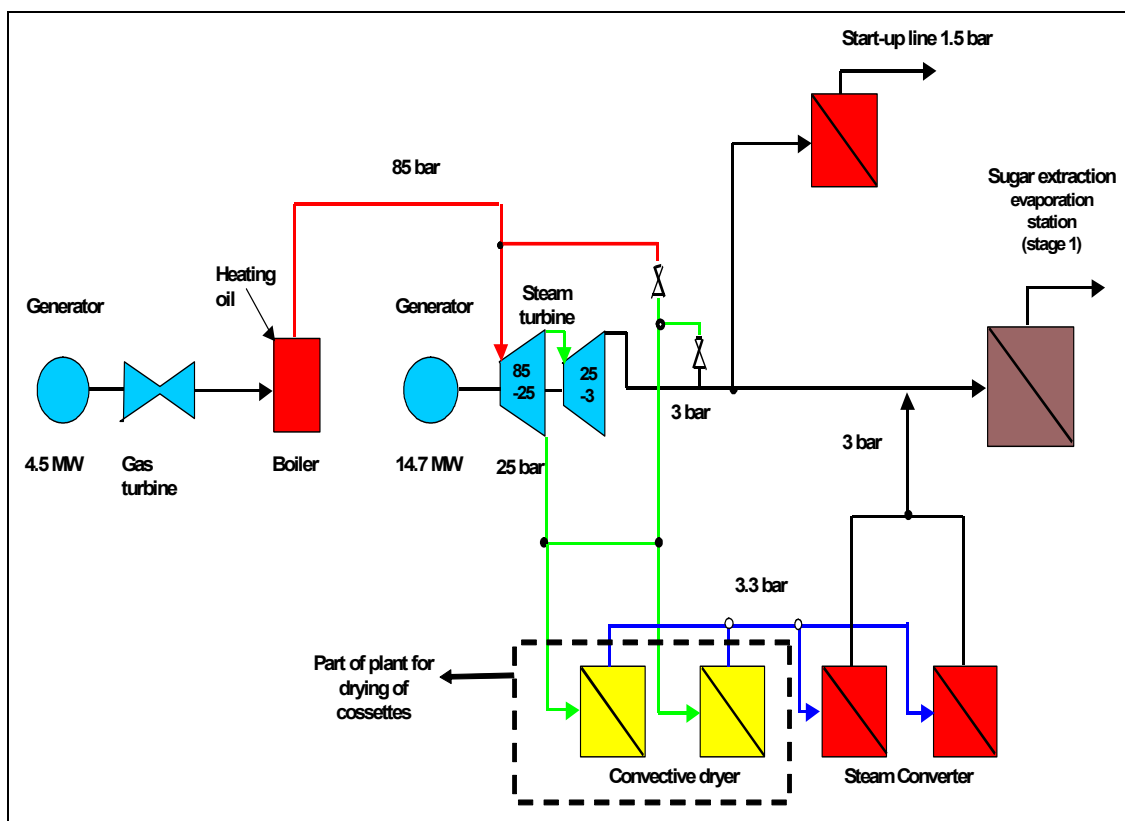

Figure 4.70: CHP and steam system of a sugar installation where cossettes are steam dried

The hot steam, which produced a pressure of 85 bar and a temperature of 525 °C with a maximum mass flow of 110 t/h, is fed to the downstream counter-pressure offtake steam turbine. The turbine is able to draw off, via the bleed system, the necessary quantity of steam, with a pressure of between 11 and 25 bar, to heat the evaporative drier. The vapours released in the driers are re-used in the evaporating station in the sugar extraction process. The vapours which contain organic substances, e.g. acids, are passed through a downstream steam converter and then used to heat the first stage of the evaporating station. The non-condensable gases containing a certain amount of water vapour are discharged to air from the steam converter.

In the second installation, HTD is used. Pressed pulp is mixed with molasses and then dried in a co-current drum drier using direct heating. A mixture of the flue-gas from the furnace and flue-gas from steam generation is used. Another portion of the drying media is the so-called leaking or cooling air. Air leaks in because the fixed mixing chamber and the rotating drum reportedly cannot be sealed completely. The cooling air, approximately 20 % of the drying gas volume, is also necessary to provide a sufficient flow for the transportation of the particles to be dried.

A flow sheet and data for the operation and energy use of HTD are shown in Figure 4.71. The figures were standardised and simplified for the sake of comparison with the other two methods of drying used in the two other installations of the case study. If the pulp of a factory with a capacity of 10000 t/d (417 t/h) was dried at the installation, about 46 t/h water would be evaporated in the drier. As can be seen in Figure 4.71, the furnace gas represents about 30 % of the total gas flow and about 84 % of the energy input.

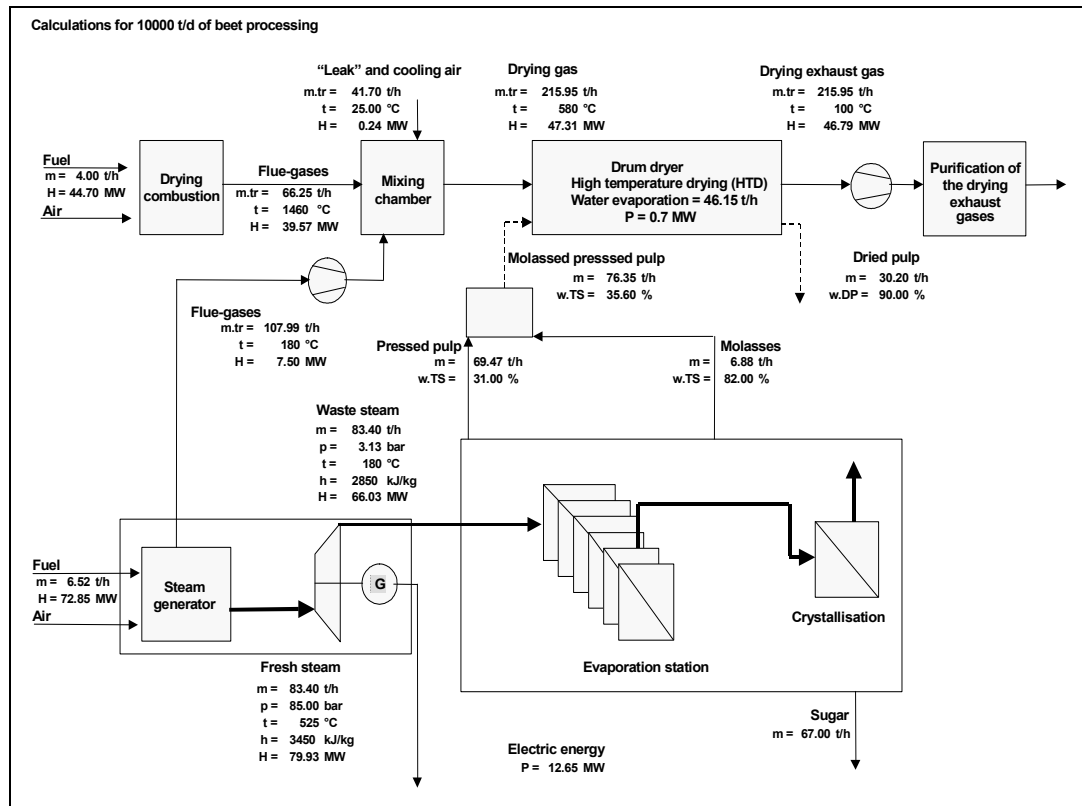

Figure 4.71: HTD of sugar beet pulp

At the third German sugar installation, beet pulp is dried using two-stage drying. Beet pulp is first dried in a low temperature belt drier, which is operated countercurrently. The drying air for the low temperature drier is heated by means of vapours, e.g. water steam, and condensates from the sugar manufacturing evaporation and crystallisation stations. In this way, it is possible to use secondary energy and to reduce the use of primary energy for HTD. Molasses are mixed to the pulp and the second stage is HTD, similar to that of the previous example.

The flow sheet of a two-stage pulp drying process can be seen in Figure 4.72. The data are again standardised for a factory with a capacity of 10000 t/d (417 t/h) of sugar beet pulp. Here, about 62 % of the total water is evaporated in the HTD stage.

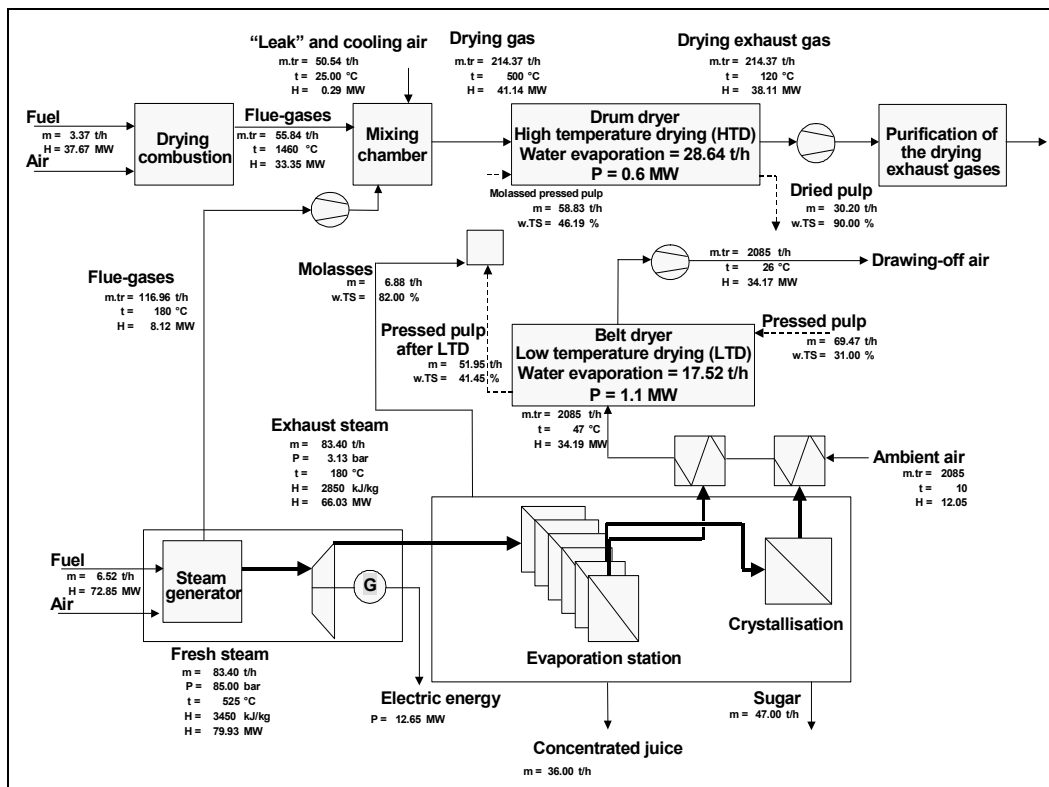

Figure 4.72: Two-stage drying of sugar beet pulp

Achieved environmental benefits

See Sections 4.7.7.1.2, 4.7.7.1.3 and 4.7.7.1.4.

Cross-media effects

See Sections 4.7.7.1.2, 4.7.7.1.3 and 4.7.7.1.4.

Operational data

For the purposes of energy considerations regarding the three examples outlined above, the framework data of the installations are standardised, as shown in Table 4.109.

Beet processing	10000 t/d (417 t/h)
Campaign length	90 d/yr
Pressed pulp mass flow	160 kg/t beet processed = 66.7 t/h
Dry substance content of the pressed pulp	31 %
Dry substance content of the dried pulp	90 %
Steam demand sugar factory	200 kg/t beets processed = 83.4 t/h
Live steam pressure	85 bar
Live steam temperature	525 °C
Thermal value of the fuel	11.2 kWh/kg (40195 kJ/kg)
Electric energy demand of the sugar factory without drying	10.4 MW = 24.96 kWh/t beets processed

Table 4.109: Standardised framework data of the three example German installations

The standardisation also assumes the complete crystallisation of the concentrated juice in the beet campaign. These standards assume that the following technical equipment is used:

- a steam generator at 85 bar and 525 °C
- a corresponding back pressure turbine
- 3 bar of back pressure for supplying the evaporator station, or 3 bar back pressure and 25 bar extraction pressure for supplying the evaporation drier
- a gas turbine for lowering the supply of electric energy during the use of an evaporation drier
- a WWTP that is capable of processing the condensate from the vapours of the evaporation drier.

Table 4.110 shows the energy demand and production data for the three installations. For comparison purposes, data for an installation without drying the pressed pulp are also included.

Process step	Units	Steam drying with FBDs	HTD	Two-stage drying	Installation without drying
Beet processing	t/d	10000	10000	10000	10000
Evaporation station steam demand	t/h	83.33	83.33	83.33	83.33
Electric energy demand for drying	MW	1.15	0.80	1.70	0
Electric energy demand for rest of installation	MW	10.40	10.40	10.40	10.40
Total electric energy demand	MW	11.55	11.20	12.10	10.40
Specific electric energy demand for beet processing per tonne of beets	kWh/t	27.72	26.88	29.04	24.96
Fuel energy HTD	MW	0	44.70	37.67	0
Steam generator fuel energy	MW	57.12	67.13	67.13	67.13
Gas turbine fuel energy	MW	16.60	0	0	0
Total thermal energy	MW	73.72	111.83	104.80	67.13
Steam turbine electric energy output	MW	7.92	11.66	11.66	11.66
Gas turbine electric energy output	MW	4.00	0	0	0
Total electric energy output	MW	11.92	11.66	11.66	11.66
Electric energy supply	MW	0	0	0.44	0
Electric energy output	MW	0.37	0.46	0	1.26

Table 4.110: Comparison of energy balances of three different options for beet pulp drying and for an installation without drying in Germany

With regards to the electric energy requirement, two-stage drying has the highest consumption, followed by steam drying using FBDs and followed by HTD, which needs the least electricity. In comparison with the electrical energy need of an installation without drying, it can be seen that the additional electrical energy needed for each technique is:

- HTD: 0.8 MW
- steam drying using FBDs: 1.15 MW
- two-stage drying: 1.7 MW.

With regards to the thermal energy requirement, HTD is the highest, followed by two-stage drying and then by steam drying with FBDs, which consumes considerably less thermal energy. In comparison with the thermal energy need of an installation without drying, it can be seen that the additional thermal energy needed for each technique is:

- HTD: 44.7 MW
- steam drying using FBDs: 6.59 MW
- two-stage drying: 37.67 MW.

The thermal energy output available for conversion into electrical energy is as follows. HTD has the highest output, followed by two-stage drying and finally by steam drying with FBDs.

In steam drying using FBDs, only 6.59 MW is needed for drying, out of a total thermal energy consumption of 73.72 MW. With the application of co-generation, the electrical energy balance of the installation is positive, that is 0.37 MW more electricity is produced as an output. Although a considerable portion of the steam that is put out by the back pressure turbine at approximately 27 bar is not fully available for conversion into electrical energy.

In HTD, 44.7 MW is needed for drying, out of a total thermal energy consumption of 111.83 MW. The specific thermal energy demand for water evaporation is low, e.g. about 1.03 kWh/kg vapour (3.7 MJ/kg).

For two-stage drying, 38 % of the water is evaporated in the LTD step but 9.7 times more air is needed in this stage than in the HTD stage. The LTD step has a higher specific energy demand. The 34 MW thermal energy demand in LTD represents about 1.9 kWh/kg (7 MJ/kg) vapour specific consumption, while the 41 MW in the HTD stage gives about 1.4 kWh/kg (5.2 MJ/kg) vapour specific energy consumption.

Applicability

See Sections 4.7.7.1.2, 4.7.7.1.3 and 4.7.7.1.4.

Economics

In Table 4.111, the selected data for a feasibility comparison of the example plants are summarised. The quoted figures are only valid for the conditions given above. Possible minor differences in revenue for by-products are disregarded.

	Units	Steam drying with FBDs	HTD	Two-stage drying	Installation without driers
Total electricity demand	MW	11.55	11.20	12.10	10.40
Total thermal energy demand	MW	73.72	111.83	104.80	67.13
Total electricity output	MW	11.48	11.66	11.66	11.66
Electric energy supply	MW	0.07	0	0.44	0
Electric energy output	MW	0	0.46	0	1.26
Fuel costs	EUR/h	1180	1789	1677	1074
Electrical power costs	EUR/h	0	0	18.00	0
Electricity output	EUR/h	-7.6	-9.4	0	-25.7
Total energy costs	EUR/h	1172	1780	1695	1048
Fuel costs	EUR 000/yr	2548	3865	3622	2320
Electric energy supply costs	EUR 000/yr	0	0	38.9	0
Electricity output earnings	EUR 000/yr	-16.3	-20.3	0	-55.5
Total energy costs	EUR 000/yr	2532	3845	3661	2264
Price of thermal energy = EUR 16.00/MWh Price of electric energy = EUR 40.90/MWh Campaign length = 2160 hours/yr Price of electricity output = EUR 20.40/MWh					

Table 4.111: Comparison of the energy costs of different ways of drying beet pulp

With regards to pressure and temperature, standard conditions are 85 bar and 525 °C, respectively. In a number of installations, co-generation produces lower steam pressure, e.g. 40 to 60 bar. In these cases, the above savings are not expected.

In addition, the electrical energy balance of an installation can only be structured in an equalised way with an evaporation drier when a gas turbine is operated. The subsequent steam generator must be able to benefit the exhaust gas flow of the gas turbine. If a gas turbine is not used, 3.63 MW electrical energy input is needed instead of actually producing 0.37 MW energy. The cost of that energy consumption is EUR 2.9 million per year. The savings would then drop to EUR 0.95 million per year.

Vapours from driers are condensed. The condensate requires treatment. If the existing WWTP capacity is not sufficient to treat the amount produced, then an additional treatment capacity is needed. However, note that the costs of waste water treatment and other related investments are not included in the calculations given above.

Summarising the table given above, energy costs are the lowest for steam drying with FBDs, followed by two-stage drying and finally HTD, which has the highest energy cost. However, overall, the investment costs are the highest for steam drying with FBDs and the lowest for HTD.

There are several methods for evaluating the expenditure costs. One is to calculate the net present value (NPV). NPV is the value of investment calculated as a sum of discounted future payments minus the investment's current cost:

$$\text{NPV} = -(\text{cost of investment}) + \sum_{i=1}^n \left(\frac{\text{income}_i}{(1+r)^i} \right)$$

where:

NPV = net present value

income = net income; this may be negative when taking into account all the costs

r = discount rate (interest in %/100)

i = year

n = operational life of a plan in years

Table 4.112 shows a comparison of expenditures expressed as NPV for the three techniques.

		Steam drying with FBDs	HTD	Two-stage drying
Investment costs	EUR million			
Drier		16	10	13
Gas turbine		4		
Total		20	10	13
Operational costs	EUR million			
Energy		-2.5	-3.8	-3.7
Other		-0.6	-0.4	-0.5
Total		-3.1	-4.2	-4.2
Operational life of an installation = 10 years				
Discount rate, r = 0.08				
Net present value (NPV)	EUR million	-40.9	-38.4	-40.7

Table 4.112: Comparison of expenditures expressed as NPV

Steam drying with FBDs and two-stage drying have practically the same NPV, while HTD is cheaper by about 6 %. However, if the calculations are done with a longer operational life, i.e. 18 years, for the driers and the gas turbine, the NPV of steam drying with FBDs is the lowest, e.g. lowest cost.

Reference literature

[65, Germany, 2002]

4.7.7.2 Reducing sugar beet soil tare

Description

Large quantities of soil, gravel and stones are transported to sugar factories as part of beet deliveries. Handling of this unwanted material consumes a lot of resources at the site, e.g. energy and water. A “clean beets” project, combining technical, economic and plant breeding measures, can reduce the amount of soil delivered to the installation.

Achieved environmental benefits

Reduced water and energy consumption.

Operational data

A Swedish example sugar beet installation has focused on reducing soil tare since the early 1980s. A “clean beets” project has resulted in a reduction of soil tare of 150000 tonnes. In Denmark, the reported figure is even higher due to a larger beet growing area. Levels are now 50 % below those typical 10 years ago.

In addition, a special bonus system is used in Sweden and Denmark to promote harvesting in good weather conditions and the optimal use of harvesters. Tests run at an example installation indicate, that once new harvesters are used appropriately, it is possible to achieve a 5 % soil tare (95 % purity) under almost all weather conditions. Figure 4.73 shows the reduction of soil tare in Sweden.

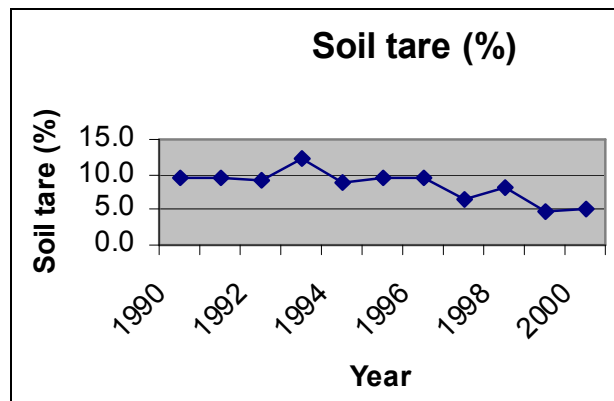

Figure 4.73: Reduction of soil tare in Sweden

Parallel to this work, these installations are working on improving the shape of sugar beets to ensure that less soil attaches to the tuber. Breeding using traditional breeding techniques has focused on the root groove of the beet, which is the main problem in beet washing.

Applicability

Applicable in sugar manufacturing.

Economics

Reduced energy and water costs.

Driving force for implementation

Reduced energy and water costs.

Example plants

Sugar manufacturers in Sweden and Denmark.

Reference literature

[1, CIAA, 2002]

4.7.7.3 Sugar beet water/waste water re-use

Description

For sugar beet processing, one of the major sources of waste water is the flume water used for transporting beet through the initial stages of the process. The flume water can be re-used approximately 20 times before it is discarded. The ultimate goal for consumption of transport water may be zero extraction from external water sources.

On many sites, transport water is re-used in extensive circuits, usually only after intermediate purification via settling ponds. Due to the formation of organic acid compounds within the flume water, it has been historical practice to correct the pH, usually with lime. Installations using biological treatment for waste water have, however, found that the need for pH correction has been eliminated. If care is taken to minimise beet damage during transport, this reduces sugar leaching into the transport water and consequently reduces the COD levels and the extent of waste water treatment before re-use.

It is reported that in most cases it is feasible, assuming there is enough storage capacity, to retain enough water from the previous year's campaign to start the new campaign. This prevents the need to extract water from a river or underground sources. Surplus water that cannot be used for the next campaign is discharged into an outlet leading to a watercourse. Some installations send the mixture of soil and water for landspreading (see Section 4.1.6).

Condensate from the evaporation and crystallisation stages is partly used as process water in several stages, including beet washing. Condensate may also be considered as a source of low grade water. For example, it is reported that sugar refineries can be made very water efficient so that all the fresh water is used in the process and a total recycling of condensate is achieved. Sugar beet is 75 % water, and the extraction process, by definition, aims to release a high proportion of that water. Approximately half of this water is lost due to evaporation or is included in various product streams.

Achieved environmental benefits

Reduced water consumption.

Operational data

In modern sugar factories, fresh water consumption is now 0.25 – 0.4 m³/t beet processed. For new plants, 0.1 m³/t beet processed water consumption may be achieved.

Applicability

Applicable in installations producing sugar from sugar beet.

Driving force for implementation

Reduced water consumption.

Example plants

Applied in installations producing sugar from sugar beet.

Reference literature

[1, CIAA, 2002, 13, Environment Agency of England and Wales, 2000, 61, CEFS, 2001, 134, AWARENET, 2002]

4.7.8 Coffee

4.7.8.1 Waste heat re-use in instant coffee manufacturing

Description

The instant coffee manufacturing process is highly energy intensive (for a description of instant coffee manufacturing see Section 2.2.13.2). Waste heat, e.g. from the extraction unit and air compressors, can be re-used during production, e.g. for extraction, and as a heating source, e.g. in offices and storage areas. A standard procedure for waste heat utilisation is also the recirculation of partial streams of exhaust air within the installation such as spray drying, e.g. using countercurrent heat-exchangers and within the roasting sector.

Achieved environmental benefits

Reduced energy consumption, e.g. heat is re-used.

Operational data

In an example installation in Germany, the hot liquid coffee extract produced during extraction is pumped over heat-exchangers that extract the heat from the coffee and, at the same time, heat the process water required for extraction. In addition, the heating of site offices and social rooms takes place using waste heat from the production. Also, the waste heat of the air compressors is used for heating the storage halls.

Applicability

Low grade heat is widely re-used in the FDM sector.

Economics

Reduced energy costs.

Example plants

One example installation in Germany.

Reference literature

[65, Germany, 2002]

4.7.8.2 Abatement of air emissions from agglomeration during instant coffee manufacturing

Instant coffee manufacturing is described in Section 2.2.13.2.

Description

During instant coffee manufacturing, after drying, a portion of the end-product is transported for agglomeration. A relatively high dust content results during agglomeration, which is largely recirculated. Subsequent fibre filter systems (see Section 4.4.3.7) with integrated dust collectors prevent dust particles from reaching the exhaust air.

Achieved environmental benefits

Reduced dust emissions.

Operational data

Fibre filters provide a very high degree of efficiency. The reported residual dust content of the exhaust air is in the region of <1 mg/Nm³.

Example plants

One example installation in Germany.

Reference literature

[65, Germany, 2002]

4.7.8.3 Biofilter – used in coffee processing

For further information on the technique, see Section 4.4.3.10.1.

Description

In an example installation, biofilters are used to prevent odours being emitted from coffee processing. The main contaminants in the exhaust air from coffee roasting are CO₂, dust and formaldehyde. The emissions depend on the composition of the raw coffee, the degree of roasting and the residual moisture content. The main operations where emissions to air are expected are: preheating of the roasting container, roasting, precooling of the product by means of finely sprayed water, drying of the product, emptying of the roasting container and cooling. During cooling with air, a considerable amount of air is produced that needs subsequent treatment.

The installation operates grinding and vacuum chambers with forced ventilation. CO₂ emissions and the remaining unburned hydrocarbons can be captured easily in a closed system. In the example installation, 8600 m³/h of air is treated by a biofilter in expanded modules. This consists of a cross current humidifier with polyethylene packaging material. The filter material is composted bark mulch. The filter modules are cylindrical in shape, made of stainless steel and have a total volume of 198 m³. The equipment also includes a 15 kW radial ventilator and a control panel. A maximum of 43.5 m³ exhaust air can be treated per m³ of filter material. At this load, no odour emissions are detected.

The odour of coffee is still very much in evidence as low as 3.5 OU/m³.

Achieved environmental benefits

Odour emissions are eliminated completely.

Cross-media effects

Disposal of the filter material. Used material is composted to reduce the organic pollution and then sent for landspreading. Condensation water is recycled, otherwise it requires treatment.

Operational data

A maximum of 43.5 m³ exhaust air can be treated per m³ of filter material. At this load, no odour emission is detected after treatment. No data are available about other emission levels.

Economics

The price of the total system was EUR 63480 (Germany 2001).

Reference literature

[65, Germany, 2002, 170, InfoMil, 2001]

4.7.8.4 Coffee roasting

Raw coffee can be roasted in a batch or continuous operation. No waste water is produced during roasting. The coffee skins produced during the roasting process, which can be up to 2 % depending on the type of coffee, are used as incineration fuel or composted.

In a **batch roaster**, the coffee is fluidised and heated to roasting temperature with hot air entering tangentially. The roasting process is stopped by feeding water into the roasting chamber. The coffee is then emptied into the cooler. The coffee skin that is flaked off during the roasting process is kept from the roasting cyclone. The air is recirculated through a heating oven. The excess air is treated before being emitted to the environment. The roasting cycle is 1 – 5.5 min. The refilling of the roasting chamber with raw coffee only takes place after the completion of the roasting, or alternatively after the emptying of the roasting chamber. The water consumption for the abrupt interruption of the roasting process amounts to 10 to 15 % of the weight of the raw coffee.

Batch roasters have a wide roasting range which facilitates the processing of the most varied types of raw coffee with the most varied roasting results. For example, in an installation in Germany, a roaster with a capacity of up to 4000 kg/h is used. This roaster is particularly suitable for roasteries with a large variety of products, high quality expectations and high production outputs. The layout of the batch roaster used in Germany is illustrated in Figure 4.74.

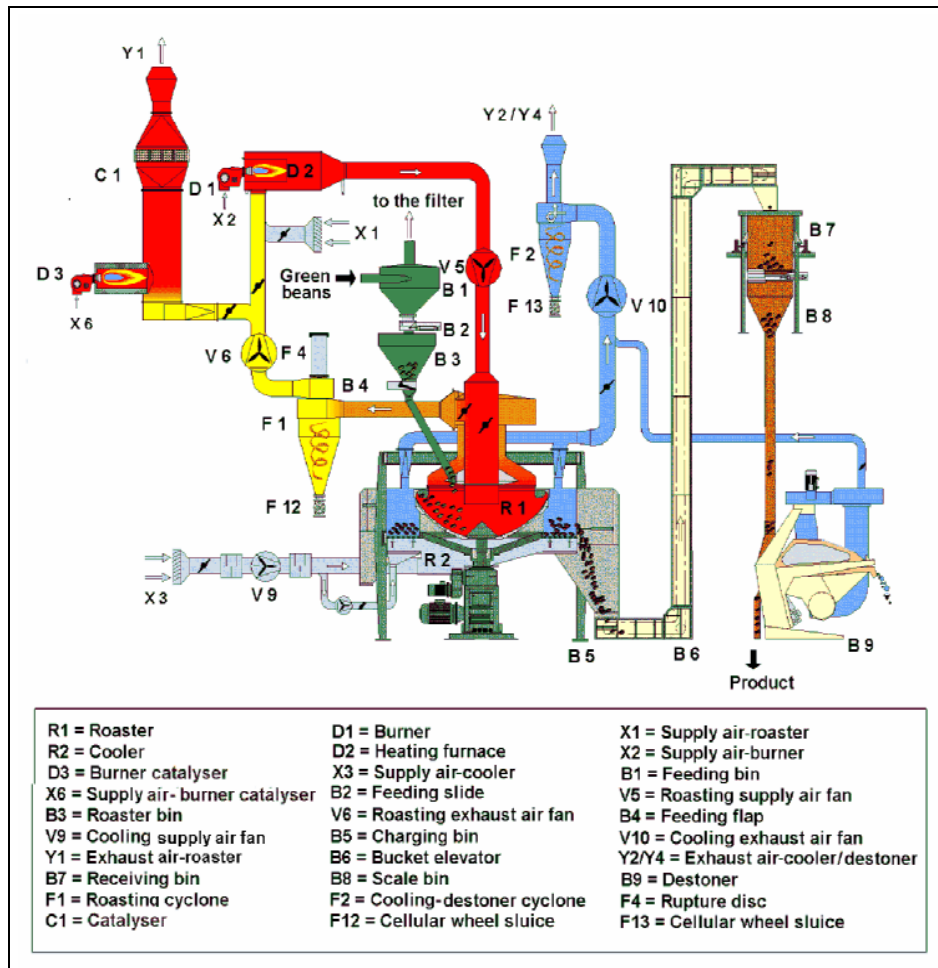

Figure 4.74: Batch roaster used by a German coffee company [65, Germany, 2002]

In a **continuous roaster**, raw coffee is supplied without interruption, and roasting and cooling take place when passing through the roaster. The coffee passes through a roasting drum containing small batch compartments in small doses. The coffee is mixed by the movement of the drum and the injection of hot air. Since the roasting takes place in mini batches, no replacement of product is possible without interrupting the roasting process. Dust and skins are removed using a cyclone. Continuous roasters are particularly advantageous where only a few types of coffee are roasted and the roasting takes place in a multiple shift operation.

In Germany, continuous roasters can reportedly process up to 4000 kg/h and roasting times are in the region of one to eight minutes. The layout of a continuous coffee roaster used in Germany is illustrated in Figure 4.75.

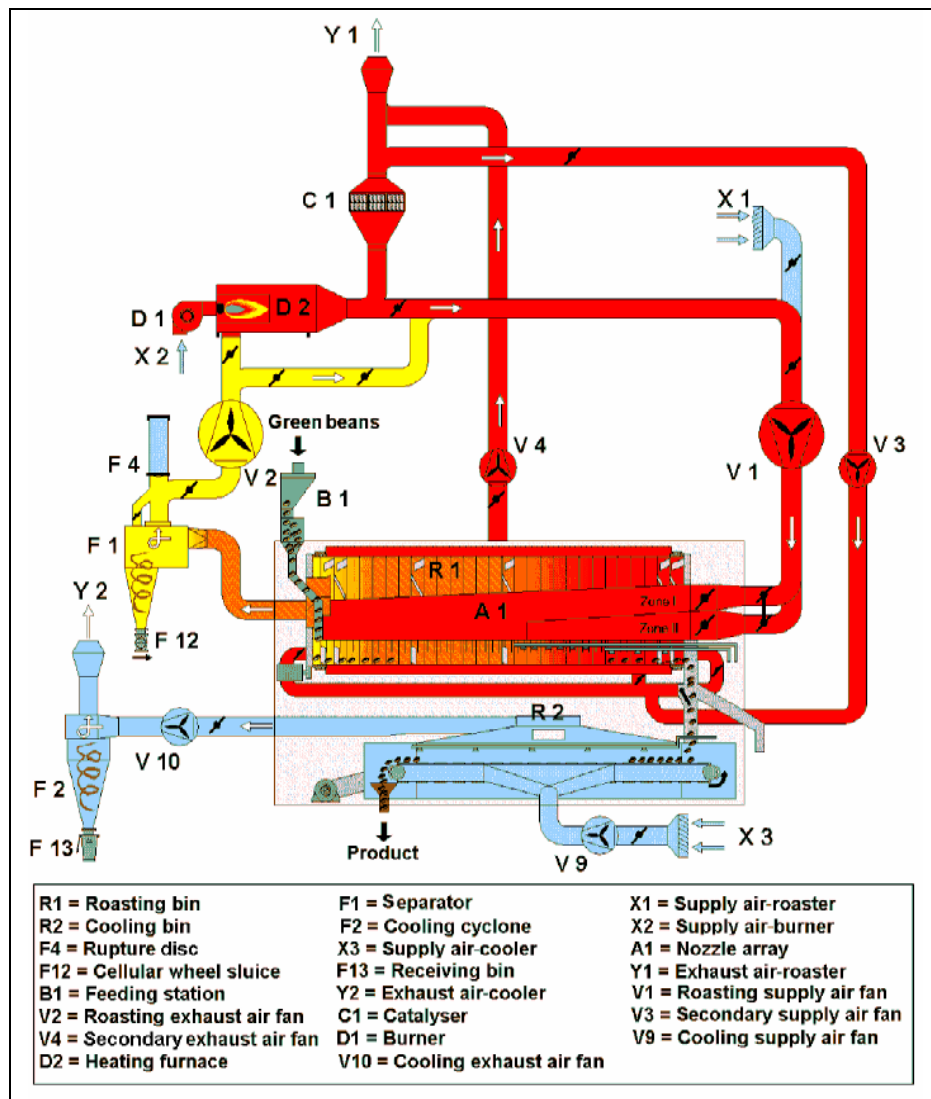

Figure 4.75: Continuous coffee roasting process used by a German company [65, Germany, 2002]

4.7.8.4.1 Recirculation of air during coffee roasting

Description

In terms of the feeding of roasting air, a distinction is drawn between non-recirculating and recirculating machines. Recirculating roasters consume less energy and produce a lower volume of waste gas for treatment.

Achieved environmental benefits

Recirculating roasters consume less energy and produce a lower volume of waste gas for treatment than non-recirculating roasters.

Operational data

Recirculating roasters consume up to 25 % less energy than non-recirculating roasters. Table 4.113 shows the mass concentration of dust from recirculating and non-recirculating roasters.

	Dust concentration after the cyclone (mg/Nm ³)
Recirculating roaster	20 – 150
Non-recirculating roaster	200 – 400

Table 4.113: Mass concentration of dust after the cyclone

Applicability

Applicable in all coffee roasting installations.

Economics

Reduced energy and waste gas treatment costs.

Example plants

Used predominantly in the German coffee sector compared to non-recirculating roasters.

Reference literature

[65, Germany, 2002]

4.7.8.4.2 Water mist cooling of roasted coffee

Description

Finely atomised water is fed into the chamber to cool the product. When the air-water aerosol comes into contact with hot roasted coffee, the water drops evaporate.

Achieved environmental benefits

Reduced air pollution and energy consumption compared to air cooling.

Operational data

In contrast to air cooling, water mist cooling uses significantly lower volumes of air and so less waste gas needs to be treated and odour emissions are reduced. Table 4.114 shows the composition of the waste gas from air cooling, i.e. higher levels than for water mist cooling, before treatment. Less energy is consumed compared to air cooling (see Table 4.115). No waste water is produced during this process.

Waste gas temperature (°C)	40
Waste gas volume (m³/kg)*	2 – 7.5
TOC emissions (mg/Nm³)	20
Dust emissions (mg/Nm³)	75
*10 vol-% of roasting gas volume	

Table 4.114: Composition of the cooling waste gases from air cooling, before treatment

The emissions produced by the water mist cooling are removed by the roasting waste air treatment system.

Applicability

The cooled coffee leaves the roaster at approximately 60 °C and is not optimal for ground coffee. For some coffees, the 60 °C final temperature can produce an acceptable taste, but for many other coffees it does not. More than 90 % of the roasted coffee market in Europe is ground coffee. This cooling system can, therefore, only be used under certain circumstances. The process is predominantly used in densely built-up residential areas.

Economics

Reduced costs with regard to energy and waste gas treatment compared to air cooling.

Example plants

Used in the German coffee sector.

Reference literature

[65, Germany, 2002, 186, CIAA-EUCA, 2003]

4.7.8.4.3 Coffee roasting followed by catalytic oxidation of the waste gases

Description

A newly constructed large-scale coffee roasting example installation in Germany, which will be called **Plant A** in this section, uses recirculating (see Section 4.7.8.4.1) batch and continuous roasters and has a roasting capacity of around 12000 t/yr during dual-shift operation. Roasting, storage and transportation of the roasted or ground coffee takes place under inert conditions, i.e. a low oxygen environment. To achieve a low oxygen environment, approximately 2 l/kg roasted coffee of carbon monoxide captured during the grinding process is added to the air for the pneumatic transportation of the ground and roasted coffee containers. Pipelines and containers need to be gas-proof to retain the released gas within the system. Waste gas is treated using catalytic incineration.

Plant B is another large-scale coffee roasting example installation, where 500 g vacuum packs are exclusively produced. The annual capacity is 44500 tonnes of roasted coffee during 3900 hours of operation and the average production is 140 tonnes of roast coffee in two shifts per day. Five roasting lines with a total capacity of 13640 kg/h are used. The roasting plants consist of recirculating (see Section 4.7.8.4.1) batch roasters, with a capacity of approximately 2200 kg/h, and roasters with water mist cooling (see Section 4.7.8.4.2) with a capacity of approximately 3080 kg/h. The waste gases are treated using a catalytic incinerator, which carries out a substantial removal of odour emissions. The CO₂ from the ground coffee plants is collected and used as a protective gas against oxygen for the ground coffee until it is vacuum packed.

Achieved environmental benefits

See Section 4.4.3.11.3.

Cross-media effects

See Section 4.4.3.11.3.

Operational data

Table 4.115 shows a comparison of consumption and emission levels of different coffee roasting processes.

Consumption and emission levels	Unit ¹	Emission levels from a roaster ² before waste gas treatment	Plant A Batch with recirculation and air cooling	Plant A Continuous, with recirculation and air cooling	Plant B Batch with recirculation and water mist cooling (data from 2001)
Total water consumption	l/t				169.2
Roasting water consumption	l/t				130
Cooling system water consumption	l/t				200
Heating oil input	l/t				42.04
Total energy consumption	kWh/t		490	470	115.21
Roasting energy consumption	kWh/t				49.6
Packing energy consumption	kWh/t				19.6
Grinding energy consumption	kWh/t				19.6
Noise emissions in roaster	dB(A)		75	75	75
Noise emissions in ventilators	dB(A)		96	96	
Waste sent for composting after being pressed into pellets, e.g. coffee skins	kg/t	5 – 10*			2.5
All the following air emission levels were measured after catalytic incineration, except ²					
Dust emissions	mg/Nm ³		<20	<50	
Dust load	kg/h		0.1	0.018 – 0.275	
TOC emission (concentration)	mg/Nm ³	10000	<50	<50	3.8 – 29.2
	kg/t				0.00963
TOC emission (load)	kg/h		0.25	0.018 – 0.275	
Odour emissions ³ The odour of coffee is still very much in evidence as low as 3.5 OU/m ³	OU/Nm ³	150000			577 – 1138
	GE/Nm ³	300000			1155 – 2276
Carbon dioxide (CO ₂)	V/V	1 – 3			
Carbon monoxide (CO)	mg/Nm ³	500 – 3000			
¹ per unit of raw coffee					
² the type of roaster is not specified, e.g. batch or continuous					
³ in accordance with VDI guideline 3881 – sheet 1 to 4					
*25 l/kg, particle size >100 µg					

Table 4.115: Comparison of consumption and emission levels of different coffee roasting processes

Economics

In **plant B**, the investments to reduce emissions during the roasting process amounted to approximately 5 to 10 % of the total investments of the roasting and packing lines, excluding building components.

Reference literature

[65, Germany, 2002, 170, InfoMil, 2001]

4.7.8.4.4 Biofilter – used in coffee processing

For further information on the technique, see Section 4.4.3.10.1.

Description

In an example installation, biofilters are used to prevent odours being emitted from coffee processing. The main contaminants in the exhaust air from coffee roasting are CO₂, dust and formaldehyde. The emissions depend on the composition of the raw coffee, the degree of roasting and the residual moisture content. The main operations where emissions to air are expected are: preheating of the roasting container, roasting, precooling of the product by means of finely sprayed water, drying of the product, emptying of the roasting container and cooling. During cooling with air, a considerable amount of air is produced that needs subsequent treatment.

The installation operates grinding and vacuum chambers with forced ventilation. CO₂ emissions and the remaining unburned hydrocarbons can be captured easily in a closed system. In the example installation, 8600 m³/h of air is treated by a biofilter in expanded modules. This consists of a cross current humidifier with polyethylene packaging material. The filter material is composted bark mulch. The filter modules are cylindrical in shape, made of stainless steel and have a total volume of 198 m³. The equipment also includes a 15 kW radial ventilator and a control panel. A maximum of 43.5 m³ exhaust air can be treated per m³ of filter material. At this load, no odour emissions are detected.

The odour of coffee is still very much in evidence as low as 3.5 OU/m³.

Achieved environmental benefits

Odour emissions are eliminated completely.

Cross-media effects

Disposal of the filter material. Used material is composted to reduce the organic pollution and then sent for landspreading. Condensation water is recycled, otherwise it requires treatment.

Operational data

A maximum of 43.5 m³ exhaust air can be treated per m³ of filter material. At this load, no odour emission is detected after treatment. No data are available about other emission levels.

Economics

The price of the total system was EUR 63480 (Germany 2001).

Reference literature

[65, Germany, 2002, 170, InfoMil, 2001]

4.7.9 Drinks

4.7.9.1 Segregation of outputs, to optimise use, re-use, recovery, recycling and disposal (and minimise water use and waste water contamination)

This technique is described in Section 4.1.7.6.

Reported examples of where the technique is applied

There are likely to be many other opportunities to apply this technique within the sector.

- clarification involves the addition of fining agents. It is reported that sediments from clarification are segregated by centrifugation or filtration
- during alcoholic fermentation, lees are separated from wine (racking) every three to four months and collected instead of flushing them into the WWTP
- before bottling, wine is passed through a filtration system to remove remaining solids and insoluble turbid compounds
- waste water with a high sugar/fermentable content can be re-used in other industries, e.g. for yeast production
- returning strong liquors to the process, or recovering them for animal feed (see Section 4.1.7.7) or other re-use
- collecting the contents from returned containers rather than washing them to drain.

Applicability

Applicable to all drinks manufacturing installations.

Reference literature

[134, AWARENET, 2002]

4.7.9.2 Dry cleaning

This technique is described in Section 4.3.1.

Reported examples of where the technique is applied

There are likely to be many other opportunities to apply this technique within the sector.

- the residues from wine processing, e.g. grape stems, pomace, marcs and lees are collected separately before cleaning the equipment with water
- catchpots over floor drains are used to keep residues, e.g. grain and fruit skins, out of the drainage system.

Applicability

Applicable at all drinks manufacturing installations.

Reference literature

[134, AWARENET, 2002]

4.7.9.3 Recovery of yeast after fermentation

Description

After fermentation, brewers' yeast is separated and stored in tanks to be used as animal feed (see Section 4.1.7.7), re-used in the fermentation process, used for pharmaceutical purposes, sent to anaerobic WWTPs for biogas production, or disposed of as waste.

Achieved environmental benefits

Reduced waste water pollution. Reduced waste, e.g. when used as animal feed.

Operational data

It is reported that due to its very high COD level and its tendency to form organic acids, if brewers' yeast is discharged to the WWTP, the pollution load of the waste water is significantly increased.

An example brewery recognised that it was losing beer worth more than GBP 1 million/year in its waste water. A waste minimisation audit showed that 80 % of all beer losses were from a vessel that separated the beer from the brewers' yeast cells. Clear beer was run off from the vessel using a fixed standpipe, before the bottom phase containing the yeast cells, was discharged to the drain. The position of the interface between the two phases depended on the type of beer, and any beer below the level of the standpipe was lost to drain. The process was modified so that the yeast phase was drained off first, until a capacitance level switch at a low level in the vessel detected the interface. The beer was then run off to storage.

The brewers' yeast can be separated, to prevent it entering the WWTP.

Figure 4.22 shows water and waste water saving opportunities of this technique and others in a brewery.

Applicability

Applicable in breweries, distilleries and wineries.

Economics

Reduced waste water treatment charges. Low potential costs and high potential payback.

Driving force for implementation

Reduction in product loss. Avoiding high waste water treatment charges.

Example plants

Used in breweries.

Reference literature

[1, CIAA, 2002, 11, Environment Agency of England and Wales, 2000, 23, Envirowise (UK) and Dames & Moore Ltd, 1998]

4.7.9.4 Filtration**4.7.9.4.1 Filtration of the product using membrane separation**Description

Filtration of the product is carried out in several processes during drinks manufacturing, e.g. during fining and before bottling to remove the remaining solid, insoluble turbid compounds and micro-organisms. Membrane separation can be used instead of natural mineral adsorbents such as diatomaceous earth, to reduce water consumption and waste water production. This removes the risk of the filter cake and separated solids being washed away with washing waters and adding to the waste water load. The spent filter material can be dewatered. It is reported that it can be composted or possibly brought out to the vineyard or distilled, depending on the composition. The treatment and recovery of diatomaceous earth are reported to be a problem. This technique enables a strong filtration of the product and removes the remaining micro-organisms and other suspended matter. It is also used for sterilisation.

Achieved environmental benefits

Reduced water consumption, waste water pollution and problems disposing of diatomaceous earth.

Applicability

Applicable in drinks manufacturing installations where the strong filtration of the product will not adversely affect its quality. This technique is not used for fining in brewing, but it is under development. There are problems associated with achieving the desired foaming of the final product.

Example plants

Used in wine and soft drinks processing installations.

Reference literature

[134, AWARENET, 2002]

4.7.9.4.2 Cross-flow filtration

Description

Cross-flow filtration is filtration where the feed-water flow is parallel to the membrane. All of the feed-water flow needs to be brought under pressure. The principle is shown in Figure 4.76

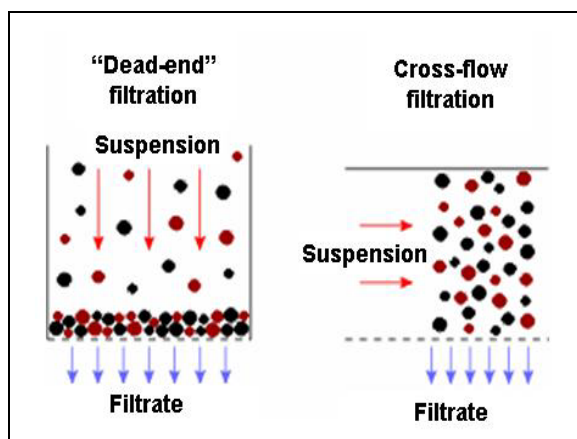

Figure 4.76: The principle of cross-flow filtration, compared to dead-end filtration

The cross-flow system is applied for RO, nanofiltration, ultrafiltration and microfiltration, depending on the pore size of the membrane (see also Section 4.5.4.6).

Achieved environmental benefits

When cross-flow filtration takes place, feed-water can be recycled and material can be recovered.

Cross-media effects

Energy consumption.

Operational data

Cross-flow filtration has a high energy consumption because all the feed-water is put under pressure. Compared to dead-end filtration, where all of the water passes through the filter and the residue builds up on the filter, cross-flow filtration has the advantage of reduced fouling. The filter is relatively resistant to fouling and can be easily cleaned.

It is reported that the main advantage of cross-flow filtration in winemaking, is the removal of almost all bacteria from the wines. In a study, unfiltered wines showed high bacterial counts and were sensitive to spoilage if exposed to higher temperatures. Cross-flow filtration through 0.22 μm removed almost all of the bacteria and thereby eliminated the chance of bacterial spoilage if the wines are to be exposed to higher temperatures. The minor changes caused by cross-flow filtration in the alcohol concentration, titratable acidity, extract and colour are explained by the wines being cleaner than the corresponding unfiltered wines. No oxidative changes of the wines were experienced from the cross-flow filtration process. The tasting panel found no significant differences between the unfiltered and the cross-flow filtered wines of Pinotage, Shiraz and Cabernet Sauvignon.

Applicability

Widely applicable in the FDM sector.

Example plants

Applied in breweries, wineries, dairies and WWTPs.

Reference literature

[13, Environment Agency of England and Wales, 2000, 23, Envirowise (UK) and Dames & Moore Ltd, 1998, 236, Ellis L., 2002]

4.7.9.4.3 Recovery of filter material when the product is filtered using natural mineral adsorbentsDescription

Filtration of the product is carried out in several processes during drinks manufacturing, e.g. during fining and before bottling to remove the remaining solid, insoluble turbid compounds and micro-organisms. Filtration with natural minerals, e.g. bentonite and diatomaceous earth, provides a rough filtration, leaving some matter in the product. This process is reported to improve the quality of wine. The filter material can be collected, to prevent it from being washed into the WWTP. It is reported that it can be treated for re-use, composted or possibly brought out to the vineyard or distilled, depending on the composition.

Cross-media effects

Unless the filter is collected separately, it will be released to the WWTP leading to pollution of the waste water.

Operational data

In wine processing, it is reported that filtration with natural mineral adsorbents keeps its quality at a high level, e.g. the stronger the filtration, the poorer the wine will be.

It is reported that diatomaceous earth can be dehydrated and then channelled into a reactor where it is gently dried and smouldered in a stream of hot air. After this process, the diatomaceous earth can be re-used fully for filtration purposes. The exhaust gas leaving the reactor requires treatment. As the diatomaceous earth can be recycled many times, a reduction of filtration and disposal costs is achieved.

Applicability

Applicable in drinks manufacturing installations where a rough filtration of the product is needed, e.g. in wineries.

Example plants

Used in the processing of wine, beer and apple juice.

Driving force for implementation

Reduced product losses.

Reference literature

[134, AWARENET, 2002, 200, CIAA, 2003, 255, Germany, 2005]

4.7.9.5 Bottling

Within the bottling department, the bottle cleaning machine is the biggest consumer of fresh water, and therefore also the source of most of the waste water.

4.7.9.5.1 Integrated bottling installationDescription

An example installation produces distilled wines, neutral alcohol, grain spirit, essences and distilled rum and whisky. The annual production volume is 70 million standard 0.7 litre bottles. A new bottling line was installed to reduce the energy consumption.

Currently, incoming raw materials are checked for compliance with quality limits. Before the raw materials enter the production process, the liquid raw materials are stored in large steel tanks and non-liquid raw materials are stacked in the pallet store. The mixing department blends the basic materials in accordance with defined recipes. This is done in special mixing tanks. The metering of all basic materials, including the conditioned product water, is controlled by “weight dosage” and a computer system. To remove SS, the mixed batches are then filtered using bed filters. Different filter beds with different separation efficiencies are used for each individual type of spirit. After a quality check is made by the analytical laboratory, the final mixed and filtered product goes to the bottling line. A flow diagram of this process is shown in Figure 4.77.

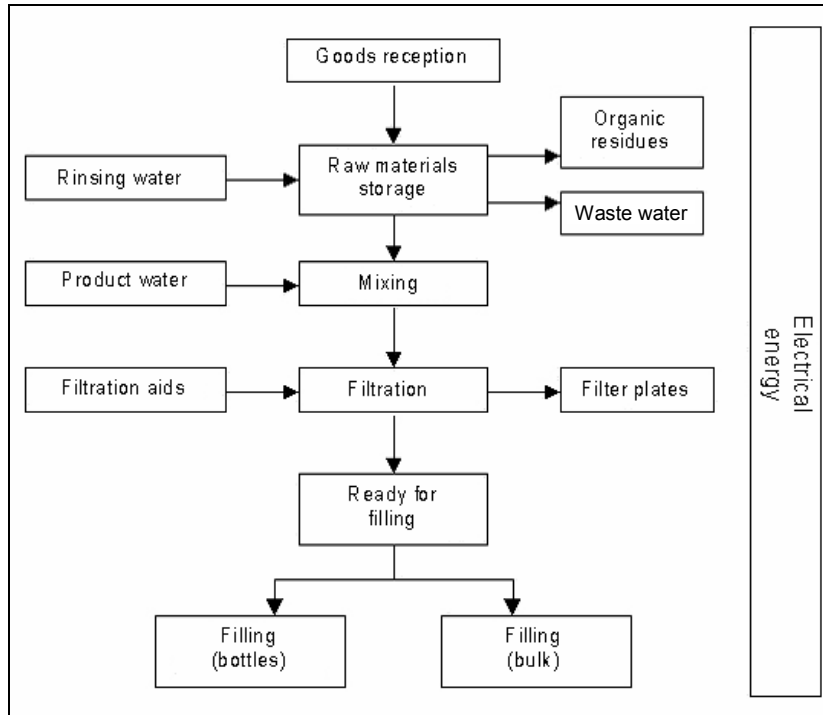

Figure 4.77: Flow diagram of the processing of spirits

The bottling line is shown in Figure 4.78.

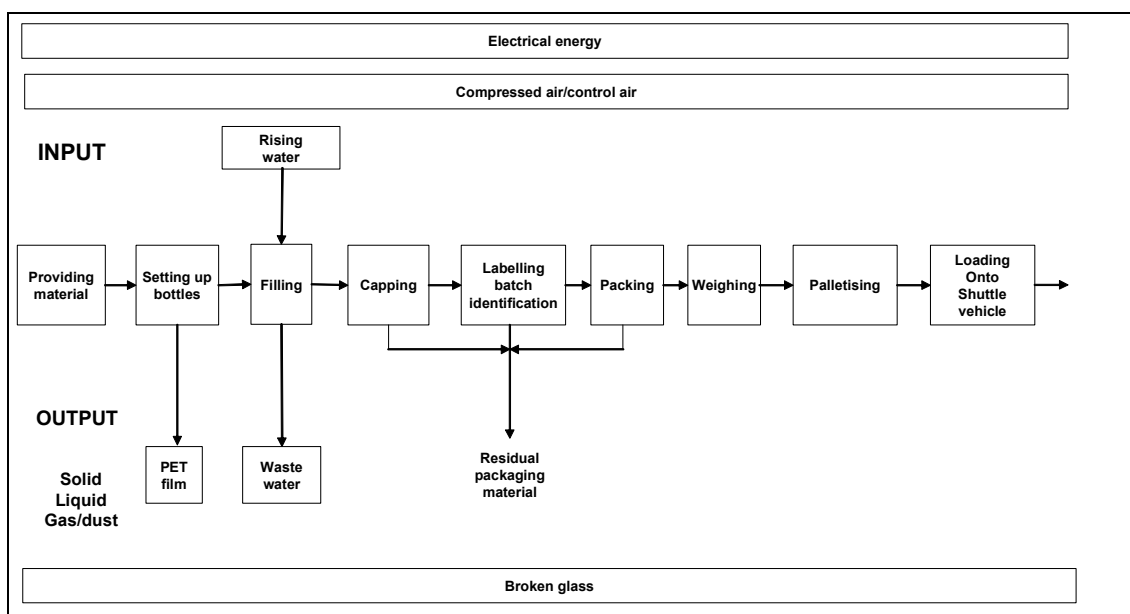

Figure 4.78: Flow diagram of the bottling line

During the first stage, stacker systems are used to supply individual units with the pallets of empty bottles and the cartons. These are also used for the closures and labels required for bottling and packaging. The empty bottle pallets are placed on conveyor belts and the protective plastic film is then removed manually. The pallet enters the slider unit, where the empty bottles are slid off one layer at a time and are then arranged in a single file on the bottle conveyors. Then they are fed to the bottling units. The protective plastic film is collected, pressed into bales and sent to a recycling company.

The empty bottles are filled on the rotary bottling unit and then capped. The first bottle filled is always tested. Bottling starts after clearance has been given by the laboratory. Control systems on the filling units monitor the bottles for the correct filling level and correct closure. Short or uncapped bottles are automatically removed. The filled bottles then go to a labelling unit. Self-adhesive plastic film labels are used as well as traditional paper labels. Ink-jet printers add the prescribed batch identification information.

The filled bottles are then packed. There are two types of packing machines, the ones that work based on the wraparound principle and the ones that work based on the folding box principle. The wraparound principle performs four operations in a single process. It erects the carton, inserts the contents, closes it and feeds it on. One machine is needed instead of four.

The full cases may be labelled and then passed via a carton weigher to the palletising systems. The carton weigher detects any deviation from the target weight for the carton and removes such cartons from the production process as rejects. After weighing, the cartons are automatically palletised on “euro pallets”. The pallets, loaded with cases of full bottles, are then wrapped in a stretch film to ensure a better load security during transport.

As the installation does not have an internal store for finished products on the site, its entire production is taken by shuttle vehicles to an external logistics store. Two shuttle vehicles at a time can dock at the loading stations and be loaded with 30 pallets each within three minutes. No forklift trucks are used in this process.

Achieved environmental benefits

Significant reduction in energy consumption. Reduced noise pollution.

Cross-media effects

Waste water is produced, e.g. from processing, cleaning and rinsing. Waste is produced, e.g. PET film, residual packaging material and broken glass.

Operational data

The new bottling line consumes an average of 1.0 to 1.5 kWh less energy per 1000 standard bottles than the older technology (not described). The shuttle conveyor saved 15600 litres of diesel fuel, compared to loading full pallets with forklift trucks. Table 4.116 shows consumption and emission levels of the bottling line in the year 2000. Table 4.117 shows production, energy consumption and waste water data from 1999 to 2001.

Parameter	Units	Level
Water consumption	m ³	38830
Built in product	m ³	25600
Energy consumption		
Fuel	MWh	1942.9
Electricity	MWh	2316.6
Specific energy consumption	kWh/10 ³ bottle	9.4
Production		
Vinasse	tonnes	3539
Vinasse potash	tonnes	754
Waste		
Cardboard/paper	tonnes	258
Scrap metal	tonnes	10
Broken glass	tonnes	157
	kg/10 ³ bottles	3.5 – 4.0
PET film	tonnes	113
	kg/10 ³ bottles	1.0 – 1.2
Waste water		
Volume	m ³	13230
	m ³ /10 ³ bottles	0.199
COD content	mg/l	1900 – 5400
BOD ₅ content	mg/l	1200 – 3000
pH		7.7 – 8

Table 4.116: Consumption and emission figures of the bottling line (2000)

Parameter	Unit	1999	2000	2001 (until Nov.)
Total production	10 ³ bottles	69636	66465	62083
Production of new technology	10 ³ bottles	47256	48072	47189
Total electricity	kWh	2282840	2316640	2097560
Electricity of new technology	kWh	462928	469502	442830
Total electricity	kWh/10 ³ bottles	32.8	34.8	33.8
Electricity of new technology	kWh/10 ³ bottles	9.8	9.8	9.4
Fuel	kWh	2065620	1942920	1606480
	kWh/10 ³ bottles	29.7	29.2	25.9
Waste water	m ³	17292	13229	
	hl/10 ³ bottles	2.48	1.99	

Table 4.117: Production, energy consumption and waste water generation figures for a spirits installation from 1999 to 2001

Technology applied	Energy consumption (kWh/10 ³ bottles)		
	Production units	Labelling	Packing
Old technology (average 10 years)	8.2 – 8.4	0.38	2.77
Total including modern and old technology (less than 6 years)	7.3 – 7.6	0.36	0.91
Modern technology	5.9 – 6.5	0.3	0.61
Old technology	1.1 – 1.4	0.06	0.3

Table 4.118: Average energy consumption figures comparing the old and new technology

There is also a reduction in noise pollution due to the smoother action of the new mechanical systems.

Applicability

Applicable in bottling installations.

Economics

The fully automated shuttle system saves the high running costs and operating resource requirements of the forklift truck technology. In addition to reducing resource consumption, the technological modernisation had a substantial economic effect as a result of the increased hourly output. This is one reason for the 10 % reduction in production costs per standard bottle and the 7.5 % increase in productivity, when comparing 1999 to 2001.

Example plants

A spirits production installation in Germany.

Reference literature

[65, Germany, 2002]

4.7.9.5.2 Multistage bottle cleaning system

Description

A reduction in water consumption can be achieved by a combination of different methods for the different zones of the cleaning machine. The various process steps are grouped in a single system. The basic formula for calculating the amount of cleaning process needed is:

$$\text{Cleaning} = \text{temperature} \times \text{time} \times \text{concentration} \times \text{mechanical force}$$

Where: concentration = content of chemicals
mechanical force = strength of mechanical cleaning, e.g. of spray nozzles.

These parameters are determined, to some extent, by the design of the cleaning machine. Other quantities such as the type and concentration of the chemicals, additives and surfactants used are optimised in co-operation with the chemicals supplier. This cleaning process, which takes place primarily in the soaking zone and the caustic bath, results in clean germ-free bottles. The interaction of chemical, thermal and mechanical effects ensures that the bottles are cleaned within a certain time.

The bottle cleaning process is shown schematically in Figure 4.80. The bottles pass through the individual zones of the bottle cleaning machine in the order shown in Figure 4.79.

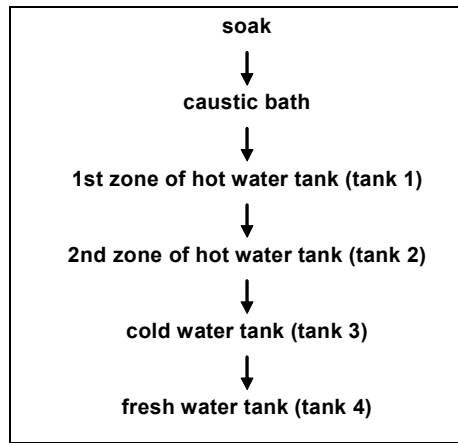

Figure 4.79: Bottle cleaning and rinsing steps

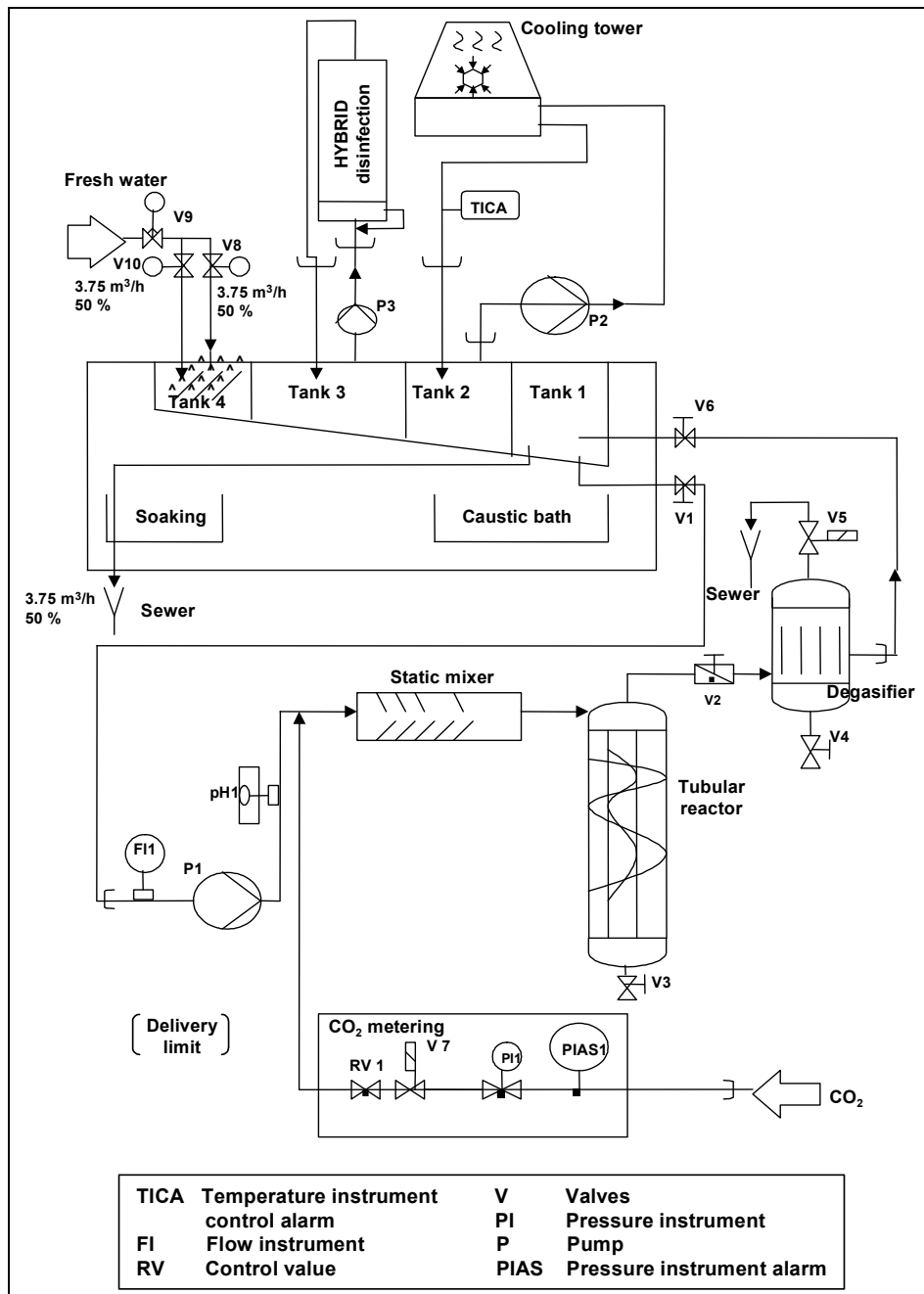

Figure 4.80: A bottle cleaning process with pH control to reduce water consumption [65, Germany, 2002]

In the caustic bath, the glass bottles are cleaned using approximately 1.8 % caustic soda solution. The alkali, chemicals and small dirt particles remaining in the bottles leaving the caustic bath, then have to be washed away during the subsequent cleaning zones. The dirt particles entrained from the caustic bath can be rinsed off without difficulty in the first spray zones. It is considerably more difficult to remove any alkalinity carried into the first hot water zone (tank 1) with the bottles. As the bottles leave the main bath, they are still wet with this cleaning solution, resulting in liquor entrainment.

The pH of the first basin after the main caustic bath is originally between 10 and 11. This high pH favours deposition of lime and magnesium salts, i.e. removal of scale, when hard drinking water is used. Neutralisation of the water may reduce scaling considerably.

In an example installation, carbon dioxide neutralisation lowered the pH to 7.5 – 8. The neutral pH enhances the efficiency of the disinfectants, and considerably reduces the need for chemical agents.

The neutralised water is pumped from the second hot water zone (tank 2) and is added to the closed cooling circuit to cool the spray water. This cools the cleaning water in this zone. The cooled water is then fed back into the second hot water zone (tank 2).

Achieved environmental benefits

Reduced water consumption and consequently waste water volumes. Reduction in waste water contamination loads, due to reduced chemical consumption. Reduced energy consumption. Reduction in transport, storage and handling of chemicals. The pH of the waste water is optimised.

Operational data

The water consumption per bottle cleaned was cut from 530 to 264 ml (51 %) in the example installation, with a consequent reduction in the waste water volume. The water consumption will vary depending on the size of the bottles and how dirty they are. Apart from the high water consumption, other disadvantages of the older bottle cleaning machines were, e.g. scale formation in the hot water zones and alkali entrainment; the need for expensive complexing agents and disinfectants and the fact that these chemicals can get into the waste water. These are eliminated with this multistage combination process. Even with a 51 % reduction in fresh water input, the return of the cooled water still ensures reliable cooling of the bottles.

Applicability

This system can replace bottle cleaning machines in existing bottling lines. For example, this process can be applied to all older bottle cleaning machines that have a water consumption of more than 400 ml per bottle cleaned, e.g. 80 % of the bottle cleaning machines in use in the German soft drinks sector are models of this kind.

It is reported that to ensure adequate cleaning quality, it is not realistic to work on the basis of a target water consumption of less than 200 ml per bottle cleaned. New models need only 150 ml of cleaning water per bottle cleaned. There is thus no potential saving for these machines.

Economics

To achieve an acceptable payback period, a water saving of at least 200 ml per bottle cleaned is needed.

Driving forces for implementation

Reduction in water, cleaning and disinfection agents consumption and costs.

Example plants

At least one soft drinks manufacturer in Germany.

Reference

[65, Germany, 2002]

4.7.9.5.3 Re-use of bottle cleaning solutions after sedimentation and filtration

Description

To save caustic soda and fresh water and to avoid unnecessary waste water loads, the contents of the bottle cleaning bath are settled and filtered at the end of the production period. The cleaning solution is pumped from the bottle cleaning equipment to a sedimentation tank using electrical energy. This tank also serves as a temporary storage unit. The settled particles are drawn off with a filtration unit that also requires the input of electrical energy for pumping. The water is then available again to be used for cleaning at the beginning of the next production period.

Achieved environmental benefits

Reduced caustic soda and fresh water consumption. Reduced pollution of waste water.

Cross-media effects

Energy consumption, e.g. for pumping.

Operational data

In an example installation in Germany, the cleaning solution, i.e. 2 % caustic soda, is re-used during the five or six working days of the week. The solution can be used for longer, e.g. weeks, if a storage tank is installed.

The outputs which are not re-used, e.g. waste water and sediment, are neutralised with carbonic acid. Alternatively, sulphuric acid (H_2SO_4) can be used. Using hydrochloric acid (HCl) could lead to the production of acidic vapours. If the pH is lower than 10, neutralisation is normally not necessary. If the neutralisation is made using CO_2 , room ventilation needs to be installed.

Figure 4.81 shows the CIP system for a bottling process in a brewery.

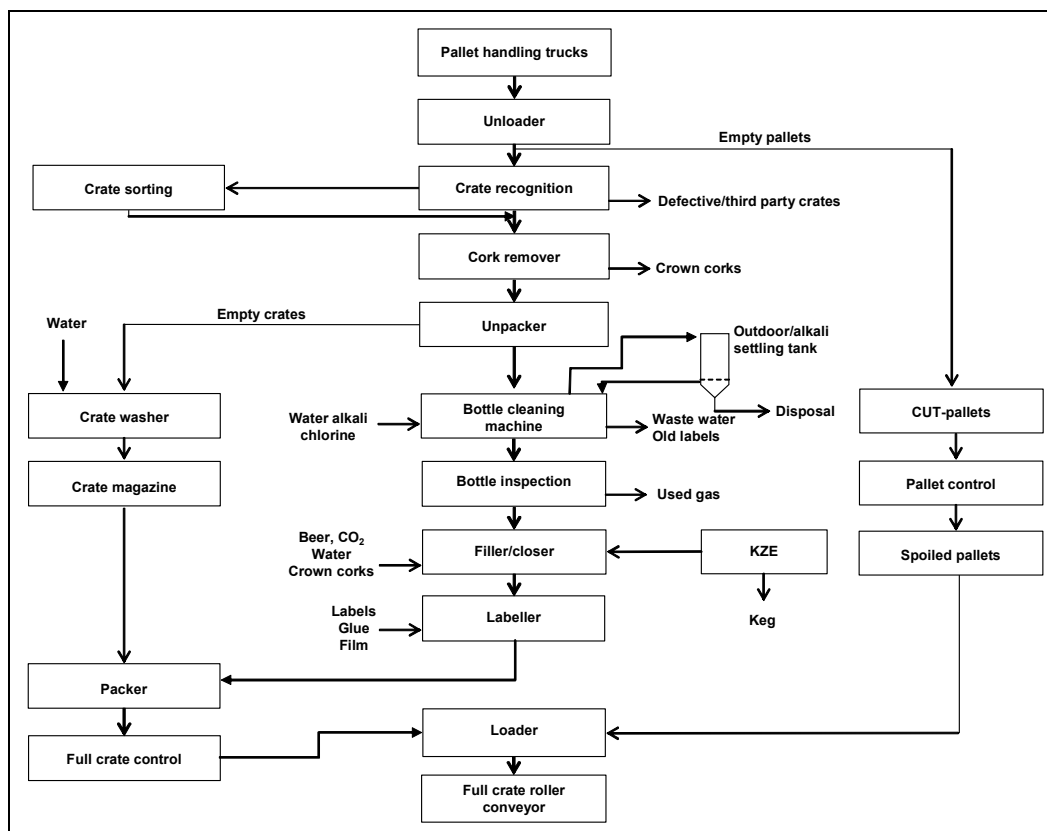

Figure 4.81: Use of a CIP system for the bottling process in a brewery

Economics

Savings in water and caustic soda costs. Reduced waste water treatment costs.

Driving forces for implementation

Cost reduction.

Reference literature

[65, Germany, 2002]

4.7.9.5.4 Optimisation of water consumption in bottle cleaningDescription

In an example brewery in Denmark, the rinsing water flow for bottle cleaning is measured (see Section 4.1.8.4) and automatic valves are installed to interrupt the water supply in case the line stops (see Section 4.1.8.7). Fresh water is used in the last two rows of the rinsing nozzles.

Final rinse-water can be re-used for the pre-rinse or other stages when cleaning bottles, cans or other containers. Where water ring vacuum pumps are used in the filling operation, contamination of the seal water can be minimised so that it can be re-used as rinse-water.

Achieved environmental benefits

Reduced water consumption and waste water load.

Operational data

In the example brewery, water consumption volumes of about 0.5 hl/hl of beer were reported.

Applicability

Applicable to all FDM installations where bottles are cleaned for filling, e.g. preserves, soft drinks, wine manufacturing, breweries and dairies.

Example plants

At least one brewery in Denmark.

Reference literature

[13, Environment Agency of England and Wales, 2000, 59, Danbrew Ltd., 1996]

4.7.9.5.5 Re-use of bottle pasteurising waterDescription

To reduce water consumption, overflows from the pasteurisers are collected in stainless steel tanks. Collected water is sent to a cooling tower and returned to the pasteuriser at a preset pressure having being dosed with, e.g. corrosion inhibitors and biocides.

Achieved environmental benefits

Reduced water and chemical consumption. Reduced waste water volume.

Cross-media effects

Possible development of legionnaires' disease, corrosion or scale build-up.

Operational data

At an example beer bottling installation, the pasteurisers were responsible for 51 % of the total water consumption of approximately 7000 m³/week. Although the pasteurisers were designed for regenerative flows, there was a constant demand for cooling water which then overflowed to the drain. There was an average flow of about 10 m³/hr with peaks of around 60 m³/hr. This constant flow to the WWTP led to losses of corrosion inhibitors and biocides. In addition, there were evaporative losses of about 5 % from the cooling towers, requiring make up water. After installing a water recovery unit from the pasteurisers on the roof of the building, the total water consumption was reduced to 17 % of the site total. Savings in water and waste water of 80 % and of 23 % in chemicals were achieved.

In this example installation, bottling and canning systems are kept separate as bottle breakage in the pasteuriser can lead to frequent depositing of product, e.g. beer into the pasteuriser water.

Applicability

The system can be used for pasteurisers, vacuum pumps and cooking retorts.

Economics

In an example packing installation, make-up water costs of approximately EUR 0.8/m³ plus a constant flow to the WWTP of EUR 1.1/m³ were achieved. This equates to EUR 7.2 – 43.2 being wasted per hour for each of the four pasteurisers. The capital costs were EUR 162000 with a payback of around 15 months.

Example plants

A packing installation in the UK.

Reference literature

[13, Environment Agency of England and Wales, 2000, 94, Environment Agency of England and Wales, 2002]

4.7.9.6 Brewing

In a brewery, water is mainly used for mashing, heat transfer and cleaning operations. Water consumption for modern breweries generally ranges from 4 – 10 hl/hl beer. Table 4.119 shows reported water and waste water saving opportunities in a brewery. Table 4.120 shows some typical achievable reductions in water consumption in breweries.

Measure	Method	Description/purpose	Equipment technique	Major benefits	Other benefits	Potential cost ¹	Potential payback ²
Liquor metering	Metering and training	Avoid excess wort production	Meter	Water and waste water savings	Consistent wort quality	High	Med
Wort disposal	Storage and disposal	Reduce waste water COD	Tank	Waste water savings		Low	Short
Keeping brewers' grains dry	Training	Minimise leaching during storage and transport	Brush (leads to dust emissions)	Waste water savings	Ease of grain	Low	Med
Cleaning mash tun and copper	High pressure hose	Reduce water use for manual cleaning	Pressure washer	Water and waste water savings	Improved cleanliness	Med	Med
Wort boiling	Reduce boiling time	Reduce steam consumption	Training	Water and energy saving		Low	Long
Copper condensate recovery	Heat-exchanger	Recover waste heat and reduce odours	Heat-exchanger	Source of hot liquor	Energy savings, reduced steam discharge	High	Long
Trub disposal	Storage and disposal	Reduce waste water COD	Tank	Waste water savings		Low	Short
Heat-exchanger automation	Actuated valves on temperature control	Optimise cooling and hot liquor production	Valves and controllers	Water and waste water savings	Consistent wort cooling	Med	Long
Heat-exchanger optimisation	Minimise cold liquor storage time	Prevent production of extra hot liquor	Training	Water and waste water savings	Cooler wort into fermenter	Low/Med	Med
Hot liquor storage	Increase capacity	Prevent overflow from hot liquor tank	New tank	Water and waste water savings		High	Long
Fermenter cooling	Cooling jacket or panels	Improved cleaning efficiency	New vessel or cooling panels	Water and waste water savings	Easier cleaning	High	Long
Fermenter cooling	Closed-circuit cooling	Reduce water consumption	Chiller and recirculation pump	Water and waste water savings	Improved cooling	Med	Short
Fermenter cleaning	Training, use of scrapers	Reduce water and waste water volumes	Training/cleaning equipment	Water and waste water savings		Med	Short
Yeast disposal	Storage and disposal	Reduce waste water COD	Tank	Waste water savings		Low	Short
Beer filtration	Cross-flow filtration	Reduce water use and waste water strength	Proprietary equipment	Water and waste water savings	Less haze	High	Med/Long

Potential costs and paybacks are for guidance only. Actual costs and paybacks will depend on the particular site.

¹ Potential cost: Low = Minor alterations to practices or existing installations (EUR 0 – a few 100s); Med = Some alterations to existing installations or minor new installations (EUR 200 – 1500); High = Extensive alterations or new installations (several EUR 1000s).

² Potential payback: Short = Months; Med = Less than a year; Long = Over a year.

Table 4.119: Water and waste water saving opportunities in a brewery [23, Envirowise (UK) and Dames & Moore Ltd, 1998]

Water saving measure	Typical reduction in process use (%)	Possible application
Closed-circuit water recycle	up to 90	Fermenter cooler
CIP	up to 60	(New)
Re-use of cleaning water	up to 50	Cask cleaning
Countercurrent rinsing	up to 40	CIP
Good housekeeping	up to 30	Hose pipes
CIP	up to 30	Optimisation of CIP
Spray/jet upgrades	up to 20	Cask cleaning
Brushes/squeegees	up to 20	Fermenter cleaning
Automatic shut-off	up to 15	Pump cooling water

Table 4.120 Typical achievable reductions in water consumption in breweries

4.7.9.6.1 Mashing

The individually defined mash programme chosen is based, among other things, on the malt quality and the type of beer to be produced. The choice of mash process influences the energy consumption in the brewhouse and hence in the brewery as a whole.

4.7.9.6.2 Mash infusion process

Description

Shredded malt is fed, together with warm brewing water, into the mash vat. This so-called mash, is heated to a temperature of 78 °C and is stirred constantly. The mash infusion process is all carried out in the mash vat.

Achieved environmental benefits

Reduced air pollution, e.g. odour, and energy consumption compared with the mash decoction process (see Section 4.7.9.6.3).

Operational data

The mash infusion process does not need to boil part of the mash, as is required in the mash decoction process. This results in energy savings of between 20 and 50 %. Table 4.121 shows the energy consumption in the brewhouse of a large brewery in Germany which uses a mash infusion process.

Consumer	Electrical energy		Heat energy			
	Total (kWh)	Specific (kWh/hl)	Total (10 ⁶ kWh)	Specific (kWh/hl)	Total (10 ⁶ MJ)	Specific (MJ/hl)
Brewhouse wort preparation	675500	0.84	8.2	10.2	29.52	36.6
Total consumption	6520730	8.1	22.82	28.3	82.152	101.9

Table 4.121: Energy consumption in the brewhouse of a large brewery with a mash infusion process

In addition, the mash infusion process reportedly has lower odour emission levels than the decoction process.

Applicability

Mash infusion is applicable in the processing of full malt beers. The mash infusion method traditionally requires high quality malt, though the malt grades available permit the use of a mash infusion process for many beer types.

Economics

No additional costs compared with the mash decoction process.

Driving force for implementation

The mash infusion process is primarily used because of its lower energy consumption, because it requires less equipment and because it is easier to automate, compared with the mash decoction process.

Example plant

A large brewery in Germany.

Reference literature

[65, Germany, 2002, 136, CBMC - The Brewers of Europe, 2002, 216, CBMC - The Brewers of Europe, 2004]

4.7.9.6.3 Mash decoction processDescription

Shredded malt is fed, together with warm brewing water, into the mash vat. This so-called mash, which is constantly stirred, is heated up to a temperature of 78 °C. Then, the thick part of the mash is separated and boiled in a mash pan, i.e. heated to 100 °C.

Cross-media effects

Higher air pollution, e.g. odour, and energy consumption in comparison to the mash infusion process (see Section 4.7.9.6.2).

Operational data

It is reported that because the mash is boiled during the process, it gives higher heat losses compared to the mash infusion process. In addition, the mash decoction process reportedly has higher odour emission levels than the mash infusion process.

Applicability

The mash decoction process is applicable when unmalted raw materials are being used, e.g. maize.

Reference literature

[65, Germany, 2002, 136, CBMC - The Brewers of Europe, 2002, 216, CBMC - The Brewers of Europe, 2004]

4.7.9.6.4 Re-use of hot water from wort coolingDescription

Hot water consumption is one of the key issues in regard to energy savings. Hot water is normally produced in a heat-exchanger when cooling down the wort from 100 °C to the fermentation temperature, e.g. about 10 °C. The hot water is stored in insulated water tanks and used for various processes, e.g. for use in production, cleaning operations, flushing brew kettles or for room heating.

Achieved environmental benefits

Reduced energy consumption. Reduced water consumption and improvements in the hot water balance of the operation. Reduced odour emissions.

Operational data

It is reported that if hot water is used for mashing only, there will be an excess of hot water giving an overflow from the hot water tank. Large amounts of water and energy can be lost due to this overflow. To optimise the hot water system, a hot water balance can be made for the entire brewery. It should carefully be investigated when, where and how much hot water is used. The investigation should also reveal if it is possible to use hot water instead of cold water heated by steam for functions such as CIP, sterilisation and bottle cleaning. It is also important that the hot water tank is sized correctly to avoid the brewery producing hot water from steam after a weekend stop in the brewhouse.

Applicability

Applicable in all breweries.

Reference literature

[136, CBMC - The Brewers of Europe, 2002, 216, CBMC - The Brewers of Europe, 2004]

4.7.9.6.5 Heat recovery from wort boiling

Description

Wort boiling is the largest single heat consuming process in a brewery. When the wort is boiled, 6–10% normally evaporates. The vapour is usually emitted to the air, wasting energy and producing unpleasant odours. Recovering heat from wort kettles saves energy and avoids odour problems.

The simplest way to recover heat from the vapour is to use it to produce hot water for various processes, e.g. for use in production, cleaning operations, flushing brew kettles or for room heating. If, however, hot water is also produced during wort cooling (see Section 4.7.9.6.4), which is very common, there may be an excess of hot water which will be released into the WWTP. In this case, there are two reported options for recovering the heat from the vapour; either using the vapour to boil the wort or using the heat in the vapour to preheat the wort before boiling.

Achieved environmental benefits

Significantly reduced energy consumption. Reduced water consumption and improvements in the hot water balance of the operation. Reduced odour emissions.

Operational data

Vapour, heated by means of vapour recompression, is conventionally used to boil the wort in a special heat-exchanger. It is reported that the heat of the vapour condensate, which has a temperature of about 100 °C, can be recovered by using it to produce hot water to boil the wort. The process is shown in Figure 4.82.

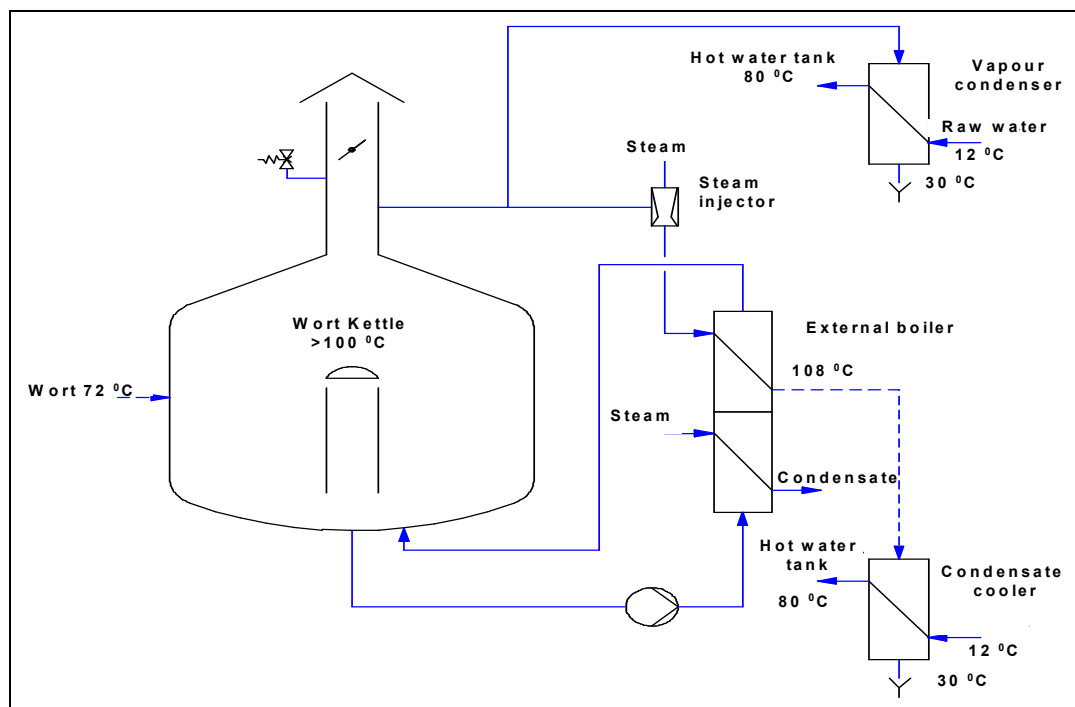

Figure 4.82: Heat recovery from a steam-heated wort kettle to produce hot water

It is also reported that the heat can also be used to produce 98 °C water for preheating the wort before boiling. The wort can be heated from 72 °C to approximately 90 °C by means of the heat recovered from the vapour condensate. This requires the installation of an energy store. Heat in the vapour condensate can also, if required, produce hot water. The process is shown in Figure 4.83.

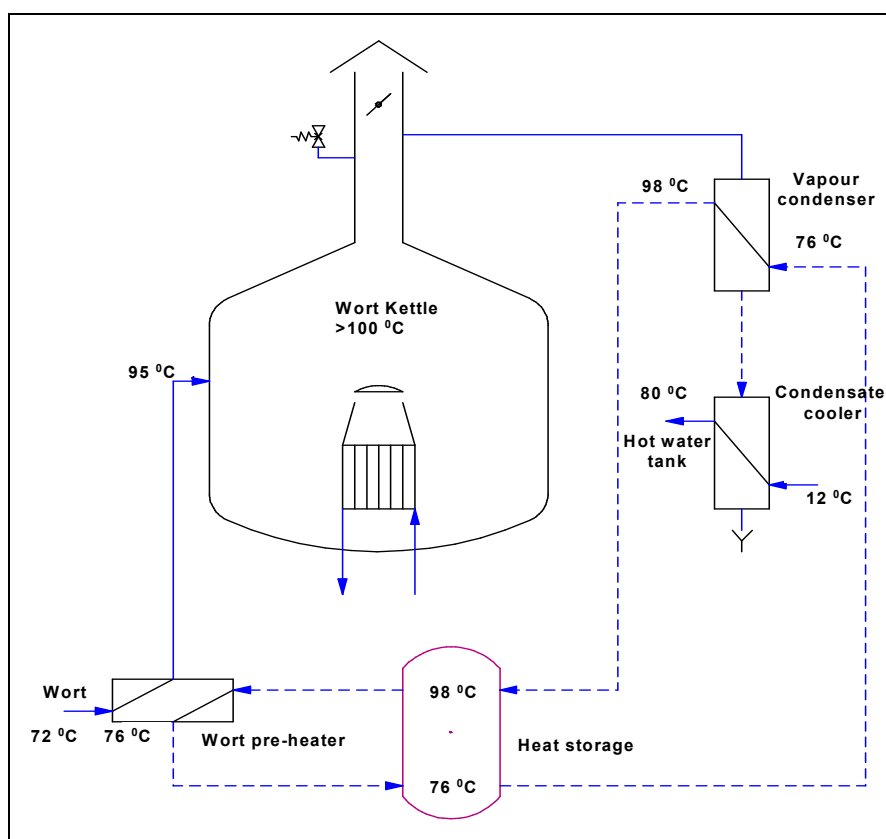

Figure 4.83: Heat recovery from wort heating for preheating the wort before boiling

Applicability

Applicable in new breweries and in existing breweries when the installation has a high and inefficient energy consumption. In these cases, heat recovery is only considered after other significant energy reductions have first been made, e.g. to a level of 41.66 – 55.55 kWh/hl (150 – 200 MJ/hl).

Economics

High capital costs.

Driving forces for implementation

Cost reductions, e.g. lower energy and water consumption costs.

Reference literature

[59, Danbrew Ltd., 1996, 65, Germany, 2002, 136, CBMC - The Brewers of Europe, 2002, 216, CBMC - The Brewers of Europe, 2004]

4.7.9.6.6 Process optimisation in a small brewery – a case study

Description

A small brewery in the UK produces mainly casked ales and lager in old, traditional premises. Recognising that water consumption, beer losses and waste water charges were above the industry average, the company installed meters in the main process areas to measure water consumption and waste water discharges (see Section 4.1.8.7), e.g. they installed float-operated top-up valves in detergent tanks and replaced faulty valves (see Section 4.1.5). They also introduced better procedures for re-using hot water from wort cooling (see Section 4.7.9.6.4), installed high efficiency nozzles for cask cleaning and optimised cleaning procedures.

Achieved environmental benefits

Improved efficiency of water and energy use and minimisation of waste water generation.

Operational data

As a result, the company achieved an annual water consumption reduction of 73000 m³ (40 %).

Economics

Low investment measures. Annual cost savings of nearly EUR 160000 were achieved with a payback period of less than three months for nearly EUR 130000 of savings.

Reference literature

[1, CIAA, 2002]

4.7.9.7 Distilling

4.7.9.7.1 Recovery of distiller's dried grains with solubles (DDGS)

Description

Alcohol can be produced from maize. The maize is ground and then dissolved in water. Sugars are produced using enzymes in a two-step process. The sugars are then fermented to produce alcohol and following this, the alcohol is separated from water by distillation. Solids from the stillage are separated using decanter centrifuges and the remaining liquid phase is evaporated. The concentrated liquid and the separated solids are mixed and dried by heating them to produce 90 % dry matter. The product is called distiller's dried grains with solubles (DDGS) and it can be used as animal feed. It contains proteins, vitamins and minerals.

Achieved environmental benefits

Animal feed is produced.

Cross-media effects

Dust may be emitted and energy is consumed.

Operational data

The temperature of the mixed liquid and solids before drying is about 70 °C and it is heated to 110 °C. The product has a temperature of about 30 °C. The evaporator is cleaned with sodium hydroxide, which can also be used to control the pH during the alcoholic fermentation. Some consumption information is shown in Table 4.122.

Parameter	Consumption/t DDGS produced
Vapour	4.5 t
Electrical energy	300 kWh
NaOH	15 kg
Water	0.1 m ³

Table 4.122: Consumption data for the drying of DDGS

Applicability

Applicable in alcohol manufacturing from grains.

Economics

The product can be sold for almost the same price as the maize.

Driving forces for implementation

Without this recovery, the stillage residue needs to be disposed of.

Reference literature

[179, Gergely, 2003]

4.7.9.7.2 Concentration of mash from molasses distilling

Description

Alcohol can be produced via the fermentation of molasses from sugar beet processing, followed by distillation/rectification. The mash, also known as slops, has a very high pollution level, e.g. BOD₅ of 18000 – 22000 mg/l, and contains compounds which are difficult to biodegrade. The discharge of slops into the waste water would hamper the operation of any WWTP. Treatment of slops is thus needed.

The slops can be concentrated by a multi-effect vacuum evaporator and processed to obtain vinasse and salts containing potassium sulphate. The vacuum evaporator achieves a dry matter content of 70 %, which is then centrifuged to separate the vinasse from the salts. Vinasse, which is a dark brown syrup containing all the inorganic substances from the wort and slops, is used as animal feed. The salts are used as a potassium fertiliser.

The condensed vapours resulting from the slops concentration are passed to the WWTP through a cationic exchanger to eliminate the ammonium. This process gives rise to ammonium sulphate, which is returned to the evaporator so that potassium in the slops can be converted to potassium sulphate.

Achieved environmental benefits

Reduced waste water pollution. Reduced waste, e.g. the vinasse is used as animal feed and the salts as a potassium fertiliser.

Operational data

Consumption and emission figures from 1999/2000 of an example German molasses distillery are shown in Table 4.123.

Parameter	Unit	Level
Water consumption	m ³ /t vinasses	1.5
Energy consumption		
Steam	t	5305
Electricity	MWh	993.2
Auxiliary materials input for the 1999/2000 campaign		
Caustic	kg	1402
Defoaming agents	kg	3419
Ammonium sulphate	kg	139300
Regenerating salt	kg	600
Products		
Vinasse	t	3539
Salts	t	754
Waste water		
Volume	m ³ /h	10 – 12
COD content	mg/l	2500 – 4000
BOD ₅ content	mg/l	1000 – 2000
NH ₄ -N content	mg/l	600 – 800
P tot content	mg/l	0.5 – 1.0
Emissions to air	Not significant. The exhaust air is cleaned by a biofilter made of peat mulch	
Noise emission	51 dB(A) (entire unit with doors closed)	

Table 4.123: Consumption and emission data for the slops evaporation unit of a German molasses distillery

Applicability

Applicable in molasses distilleries.

Driving forces for implementation

Improvement of the operation of the WWTP. Production of by-products.

Example plants

At least one molasses distillery in Germany.

Reference

[65, Germany, 2002]

4.7.9.8 Wine

4.7.9.8.1 Re-use of cleaning solution from the cold stabilisation tanks

Description

Cold stabilisation involves rapid cooling of the wine to near freezing temperatures, to precipitate calcium and potassium tartrate crystals, which may be present but which are undesirable in the bottled wine. The tartrate precipitates during ageing/racking and stabilisation.

After the vessel is emptied, a 10 % caustic solution is added, to remove the tartrate crystals. This alkaline cleaning solution can be re-used if the tartrate salts are recovered from the solution. Alternatively, tartrate elimination from wine is done with the application of electrolysis and avoiding the use of the alkaline solution. This achieves a lower energy cost when compared to wine cooling.

Achieved environmental benefits

Reduced water consumption, alkaline cleaning solution consumption and waste water pollution.

Operational data

The method of recovering the tartrate salts is not described, however, it is reported that if it is not recovered, the solution is discharged to the WWTP creating undesired pH shifts. Tartaric acid produced as a by-product can be used in the pharmaceutical and building industries.

Applicability

Applicable in all winemaking installations carrying out ageing/racking and stabilisation.

Example plants

Used in wine processing installations.

Reference literature

[134, AWARENET, 2002]

4.7.9.8.2 Gradual discharge of cleaning solution from the cold stabilisation tanks to the WWTP

Description

During ageing/racking and cold stabilisation, calcium and potassium tartrate crystals are precipitated and are then removed using an alkaline cleaning solution. To avoid undesired pH shifts, the spent cleaning solution is discharged gradually to the WWTP.

Operational data

If the alkaline cleaning solution is discharged suddenly to the WWTP, undesired pH shifts are created in the waste water, which can disrupt the operation of the WWTP.

Applicability

When the alkaline cleaning solution is no longer effective, even after the recovery of tartrate salts and when the opportunity for self-neutralisation is not available.

Driving force for implementation

Reduced disruption of the WWTP operation.

Example plants

Used in wine processing installations.

Reference literature

[134, AWARENET, 2002]

5 BEST AVAILABLE TECHNIQUES

In understanding this chapter and its contents, the attention of the reader is drawn back to the preface of this document and in particular the fifth section of the preface: “How to understand and use this document”. The techniques and associated consumption and/or emission levels, or ranges of levels, presented in this chapter have been assessed through an iterative process involving the following steps:

- identification of the key environmental issues for the sector; these include water and energy consumption, waste water generation, and to a lesser extent solid waste and odour generation
- examination of the techniques most relevant to address those key issues
- identification of the best environmental performance levels, on the basis of the available data in the European Union and worldwide
- examination of the conditions under which these performance levels were achieved; such as costs, cross-media effects, main driving forces involved in implementation of the techniques
- selection of the best available techniques (BAT) and the associated consumption and/or emission levels for this sector in a general sense all according to Article 2(11) and Annex IV of the Directive.

Expert judgement by the European IPPC Bureau and the relevant Technical Working Group (TWG) has played a key role in each of these steps and in the way in which the information is presented here.

On the basis of this assessment, techniques, and as far as possible consumption and emission levels associated with the use of BAT, are presented in this chapter that are considered to be appropriate to the sector as a whole and in many cases reflect current performance of some installations within the sector. Where consumption or emission levels “associated with best available techniques” are presented, this is to be understood as meaning that those levels represent the environmental performance that could be anticipated as a result of the application, in this sector, of the techniques described, bearing in mind the balance of costs and advantages inherent within the definition of BAT. However, they are neither consumption nor emission limit values and should not be understood as such. In some cases it may be technically possible to achieve better consumption or emission levels but due to the costs involved or cross-media considerations, they are not considered to be appropriate as BAT for the sector as a whole. However, such levels may be considered to be justified in more specific cases where there are special driving forces.

The consumption and emission levels associated with the use of BAT have to be seen together with any specified reference conditions (e.g. averaging periods).

The concept of “levels associated with BAT” described above is to be distinguished from the term “achievable level” used elsewhere in this document. Where a level is described as “achievable” using a particular technique or combination of techniques, this should be understood to mean that the level may be expected to be achieved over a substantial period of time in a well maintained and operated installation or process using those techniques.

Where available, data concerning costs have been given together with the description of the techniques presented in the previous chapter. These give a rough indication about the magnitude of costs involved. However, the actual cost of applying a technique will depend strongly on the specific situation regarding, e.g. taxes, fees, and the technical characteristics of the installation concerned. It is not possible to evaluate such site-specific factors fully in this document. In the absence of data concerning costs, conclusions on economic viability of techniques are drawn from observations on existing installations.

It is intended that the general BAT in this chapter are a reference point against which to judge the current performance of an existing installation or to judge a proposal for a new installation. In this way they will assist in the determination of appropriate “BAT-based” conditions for the installation or in the establishment of general binding rules under Article 9(8). It is foreseen that new installations can be designed to perform at, or even better than, the general BAT levels presented here. It is also considered that existing installations could move towards the general BAT levels or do better, subject to the technical and economic applicability of the techniques in each case.

While the BAT reference documents do not set legally binding standards, they are meant to give information for the guidance of industry, MSs and the public on achievable consumption and emission levels when using specified techniques. The appropriate limit values for any specific case will need to be determined taking into account the objectives of the IPPC Directive and the local considerations.

Measures to prevent and control consumption and emission levels are very much influenced by planning each process technically and operationally at each unit operation level. BAT have, therefore, been identified at this level of detail. Where consumption and emissions cannot be avoided, BAT is to reduce their impact on the environment, by the application of both technical and operational techniques.

For example, there are opportunities to avoid the unnecessary use of water at many unit operations and sometimes these can also result in energy savings, e.g. reducing the consumption of hot water not only reduces water use, but also the energy that would otherwise be needed to heat it. Avoiding unnecessary contact between water and food and carrying out dry cleaning, minimises water contamination.

The processing of food with minimum delay can prevent or minimise waste and odour problems during storage and processing, which could otherwise develop due to their decomposition over time.

The selection of BAT has been made taking into account the requirement for FDM installations to comply with other legislation relating to, e.g. public health; food and feed safety; or health and safety at work.

The FDM sector is a diverse, heterogeneous and fragmented sector, composed of a wide number of different food and drink sectors, e.g. meat, sugar and coffee. Hundreds of processes are applied in the whole sector. The environmental issues and the nature and amount of waste generated vary between the individual sectors, the processes and the raw materials used. It is, therefore, not possible, in this document, to determine specific BAT for every specific process applied in the FDM sector.

In the remainder of this chapter, the BAT for FDM installations are reported. Firstly, general BAT which apply to all installations are presented. In addition to the general BAT, there are some BAT which only apply to individual processes and unit operations in the FDM sectors where those processes and unit operations are applied. BAT are also reported which only apply to some individual sectors, i.e. those processing meat; fish and shellfish; fruit and vegetables; vegetable oils and fats; milk; starch; sugar; coffee and drinks. For the sectors for which no additional BAT have been reported, e.g. for grain mill products; dry pasta manufacturing, animal feed manufacturing; breadmaking; confectionery manufacturing; yeast manufacturing; malting; distilling; cidermaking; making soft drinks and making citric acid, the general BAT apply.

To assist the reader, the way the BAT conclusions are presented is shown in Figure 5.1. In this figure, the BAT conclusions are presented in two tiers. The first tier shows the sections listing BAT for all FDM installations and the second tier shows the sections where additional BAT for some of the individual sectors are listed.

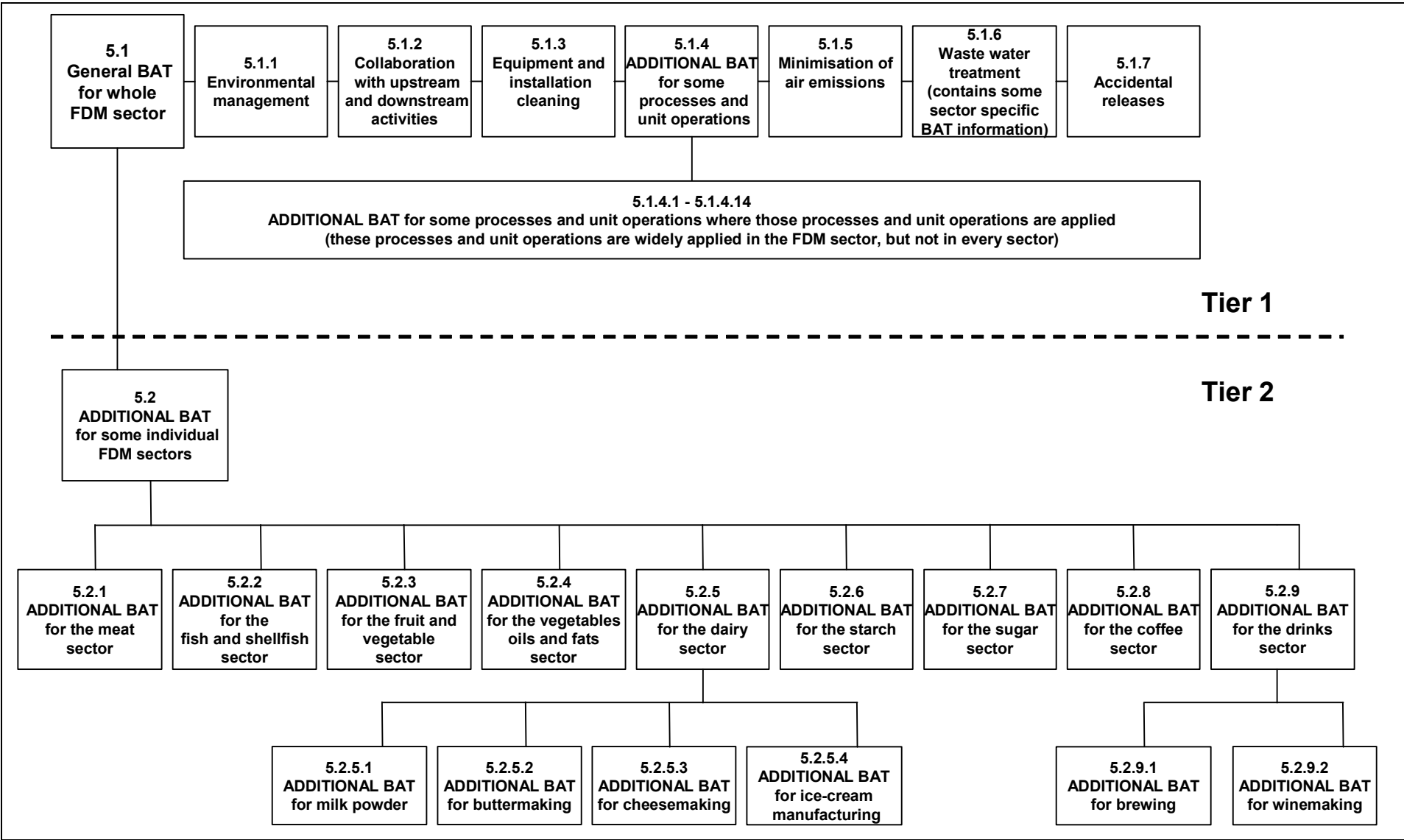

Figure 5.1: How the BAT conclusions are presented for FDM installations

The BAT in this chapter are numbered, to make them easier to read and to refer to in discussions. The numbering does not infer any hierarchy.

5.1 General BAT for the whole FDM sector

A number of techniques have been determined as general BAT applicable to all, or the majority of, FDM industrial operations and these are described in this section. These are general techniques that are commonly used across the whole sector, regardless of the processes used or the products produced.

For all FDM installations, BAT is to do all of the following:

- 1 ensure, e.g. by training, that employees are aware of the environmental aspects of the company's operations and their personal responsibilities (see Section 4.1.2)
- 2 design/select equipment, which optimises consumption and emission levels and facilitates correct operation and maintenance (see Section 4.1.3.1), e.g. to optimise the pipework system for the capacity to minimise product losses and install pipes at a gradient to promote self-draining
- 3 control noise emissions at source by designing, selecting, operating and maintaining equipment, including vehicles to avoid or reduce exposure (see Sections 4.1.2, 4.1.3.1, 4.1.3.2, 4.1.3.3, 4.1.3.4 and 4.1.5) and, where further reductions in noise levels are required, enclosing noisy equipment (see Section 4.1.3.5)
- 4 operate regular maintenance programmes (see Section 4.1.5)
- 5 apply and maintain a methodology for preventing and minimising the consumption of water and energy and the production of waste (see Section 4.1.6) incorporating:
 - 5.1 obtaining management commitment, organisation and planning (see Sections 4.1.6.1)
 - 5.2 analysis of production processes, including individual process steps to identify areas of high water and energy consumption and high waste emissions to identify opportunities to minimise these (see Sections 4.1.6.2, 4.1.6.2.1, 4.1.6.2.2 and 4.1.6.2.3), taking into account the water quality requirements for each application, hygiene and food safety
 - 5.3 assessment of objectives, targets and system borders (see Section 4.1.6.3)
 - 5.4 identification of options for minimising water and energy consumption, and waste production (see Section 4.1.6.4), using a systematic approach, such as pinch technology (see Section 4.1.6.4.1)
 - 5.5 carrying out an evaluation and doing a feasibility study (see Section 4.1.6.5)
 - 5.6 implementing a programme for minimising the consumption of water and energy and waste production (see Section 4.1.6.6) and
 - 5.7 ongoing monitoring of water and energy consumption; waste production levels and the effectiveness of control measures (see Section 4.1.6.7). This can involve both measurement and visual inspection
- 6 implement a system for monitoring and reviewing consumption and emission levels for both individual production processes and at site level, to enable actual performance levels to be optimised. Examples of parameters to monitor include: energy consumption; water consumption; waste water volumes; emissions to air and water; solid waste generation; product and by-product yield; consumption of harmful substances and frequency and severity of unplanned releases and spillages. A good knowledge of the process inputs and outputs is required to identify priority areas and options for improving environmental performance. A good monitoring system will include records of operating conditions, sampling and analytical methods and will ensure that measuring equipment is calibrated. Further information is available in the "Reference Document on the General Principles of Monitoring" [96, EC, 2003]
- 7 maintain an accurate inventory of inputs and outputs at all stages of the process from reception of raw materials to dispatch of products and end-of-pipe treatments (see Section 4.1.6.2)

- 8 apply production planning to minimise associated waste production and cleaning frequencies (see Section 4.1.7.1)
- 9 transport solid FDM raw materials, products, co-products, by-products and waste dry (see Section 4.1.7.4), including avoiding fluming except where washing involving the re-use of water is carried out during fluming and where fluming is necessary to avoid damage to the material being transported
- 10 minimise storage times for perishable materials (see Section 4.1.7.3)
- 11 segregate outputs, to optimise use, re-use, recovery, recycling and disposal (and minimise waste water contamination) (see Sections 4.1.7.6, 4.1.6, 4.1.7.7, 4.7.1.1, 4.7.2.1, 4.7.5.1 and 4.7.9.1)
- 12 prevent materials from falling on the floor, e.g. by using accurately positioned splash protectors, screens, flaps, drip trays and troughs (see Section 4.1.7.6)
- 13 optimise the segregation of water streams (see Section 4.1.7.8), to optimise re-use and treatment
- 14 collect water streams, such as condensate and cooling water separately to optimise re-use (see Section 4.1.7.8)
- 15 avoid using more energy than needed for heating and cooling processes, without harming the product (see Section 4.1.7.9)
- 16 apply good housekeeping (see Section 4.1.7.11)
- 17 minimise noise nuisance from vehicles (see Section 4.1.7.12)
- 18 apply storage and handling methods as concluded in the “Storage BREF” [95, EC, 2005]. Further controls may be required to provide and maintain the required hygiene and food safety standards
- 19 optimise the application and use of process controls to, e.g. prevent and minimise the consumption of water and energy and to minimise the generation of waste (see Section 4.1.8) and in particular:
 - 19.1 where heat processes are applied and/or materials are stored or transferred at critical temperatures, or within critical temperature ranges, to control the temperature by dedicated measurement and correction (see Section 4.1.8.1)
 - 19.2 where materials are pumped or flow, to control flow and/or level, by dedicated measurement of pressure (see Sections 4.1.8.2) and/or dedicated measurement of flow (see Section 4.1.8.4) and/or dedicated measurement of level (see Section 4.1.8.3) and using control devices, such as valves (see Section 4.1.8.7)
 - 19.3 where liquids are stored or reacted in tanks or vessels, either during manufacturing or cleaning processes, use level-detecting sensors and level-measurement sensors (see Section 4.1.8.3)
 - 19.4 to use analytical measurement and control techniques to reduce waste of material and water and reduce waste water generation in processing and cleaning and in particular to:
 - 19.4.1 measure pH to control additions of acid or alkali and to monitor waste water streams to control mixing and neutralising prior to further treatment or discharge (see Section 4.1.8.5.1)
 - 19.4.2 measure conductivity to monitor levels of dissolved salts prior to water re-use and detect levels of detergent prior to detergent re-use (see Section 4.1.8.5.2) and
 - 19.4.3 where fluids may be cloudy or opaque due to the presence of suspended matter, measure turbidity to monitor process water quality and to optimise both the recovery of material/product from water and the re-use of cleaning water (see Section 4.1.8.5.3)
- 20 use automated water start/stop controls to supply process water only when it is required (see Section 4.1.8.6)
- 21 select raw materials and auxiliary materials which minimise the generation of solid waste and harmful emissions to air and water (see Sections 4.1.9.1 and 4.1.9.2)
- 22 landspreading is an option for the outlet of materials from the FDM sector, subject to local legislation, as discussed in Section 4.1.6.

5.1.1 Environmental management

A number of environmental management techniques are determined as BAT. (See Section 4.1.1.) The scope (e.g. level of detail) and nature of the EMS (e.g. standardised or non-standardised) will generally be related to the nature, scale and complexity of the installation, and the range of environmental impacts it may have.

BAT is to implement and adhere to an Environmental Management System (EMS) that incorporates, as appropriate to individual circumstances, the following features: (see Chapter 3)

- definition of an environmental policy for the installation by top management (commitment of the top management is regarded as a precondition for a successful application of other features of the EMS)
- planning and establishing the necessary procedures
- implementation of the procedures, paying particular attention to
 - structure and responsibility
 - training, awareness and competence
 - communication
 - employee involvement
 - documentation
 - efficient process control
 - maintenance programmes
 - emergency preparedness and response
 - safeguarding compliance with environmental legislation.
- checking performance and taking corrective action, paying particular attention to
 - monitoring and measurement (see also the “Reference Document on the General Principles of Monitoring”)
 - corrective and preventive action
 - maintenance of records
 - independent (where practicable) internal auditing to determine whether or not the environmental management system conforms to planned arrangements and has been properly implemented and maintained.
- review by top management.

Three further features, which can complement the above stepwise, are considered as supporting measures. However, their absence is generally not inconsistent with BAT. These three additional steps are:

- having the management system and audit procedure examined and validated by an accredited certification body or an external EMS verifier
- preparation and publication (and possibly external validation) of a regular environmental statement describing all the significant environmental aspects of the installation, allowing for year-by-year comparison against environmental objectives and targets as well as with sector benchmarks as appropriate
- implementation and adherence to an internationally accepted voluntary system such as EMAS and EN ISO 14001:1996. This voluntary step could give higher credibility to the EMS. In particular EMAS, which embodies all the above-mentioned features, gives higher credibility. However, non-standardised systems can in principle be equally effective provided that they are properly designed and implemented.

It is also important to consider the following potential features of the EMS:

- giving consideration to the environmental impact from the eventual decommissioning of the unit at the stage of designing a new plant
- giving consideration to the development of cleaner technologies
- where practicable, sectoral benchmarking on a regular basis, including energy efficiency and energy conservation activities, choice of input materials, emissions to air, discharges to water, consumption of water and generation of waste.

5.1.2 Collaboration with upstream and downstream activities

The operations of those involved in the supply of raw materials and other ingredients to FDM processing installations, including the farmers and the hauliers, can have environmental consequences in those FDM installations. The suppliers of raw, partly processed and processed materials to FDM installations, can influence the environmental impact of those installations. Likewise, the FDM installation can affect the environmental impact of those downstream installations they supply, including other FDM installations. The environmental impact can be affected by the properties of those materials, e.g. the freshness, degree of separation of different materials and the specification.

BAT is to seek collaboration with upstream and downstream partners, to create a chain of environmental responsibility, to minimise pollution and to protect the environment as a whole, (see, e.g. Sections 4.1.7.2, 4.1.7.3, 4.1.7.12, 4.1.9.1, 4.2.1.1, 4.2.4.1 and 4.7.2.3).

5.1.3 Equipment and installation cleaning

Cleaning of FDM equipment and installations is necessarily frequent and to a high standard because there are hygiene standards which have to be maintained, for food safety reasons.

In all FDM installations, BAT is to do the following:

- 1 remove raw material residues as soon as possible after processing and clean materials storage areas frequently (see Section 4.3.10)
- 2 provide and use catchpots over floor drains and ensure they are inspected and cleaned frequently, to prevent entrainment of materials into waste water (see Section 4.3.1.1)
- 3 optimise the use of dry cleaning (including vacuum systems) of equipment and installations, including after spillages (see Sections 4.3.1, 4.7.1.2, 4.7.2.2, 4.7.5.2 and 4.7.9.2) prior to wet cleaning, where wet cleaning is necessary to achieve the required hygiene levels
- 4 pre-soak floors and open equipment to loosen hardened or burnt-on dirt before wet cleaning (see Section 4.3.2)
- 5 manage and minimise the use of water, energy and detergents used (see Section 4.3.5)
- 6 fit cleaning hoses used for manual cleaning with hand operated triggers (see Section 4.3.6)
- 7 supply pressure-controlled water and do this via nozzles (see Section 4.3.7.1)
- 8 optimise the application of the re-use of warm open-circuit cooling water, e.g. for cleaning (e.g. see Section 4.7.5.17)
- 9 select and use cleaning and disinfection agents which cause minimum harm to the environment (see Sections 4.3.8, 4.3.8.1 and 4.3.8.2) and provide effective hygiene control
- 10 operate a cleaning-in-place (CIP) of closed equipment (see Section 4.3.9), and ensure that it is used in an optimal way by, e.g. measuring turbidity (see Section 4.1.8.5.3), conductivity (see Section 4.1.8.5.2) or pH (see Section 4.1.8.5.1) and automatically dosing chemicals at the correct concentrations (see Section 4.3.9)
- 11 use single-use systems for small or rarely used plants or where the cleaning solution becomes highly polluted, such as UHT plants, membrane separation plants, and the preliminary cleaning of evaporators and spray driers (see Section 4.3.9)
- 12 where there are suitable variations in the pHs of the waste water streams from CIP and other sources, apply self-neutralisation of alkaline and acidic waste water streams in a neutralisation tank (see Section 4.5.2.4)
- 13 minimise the use of EDTA, by only using it where it is required, with the frequency required and by minimising the quantity used, e.g. by recycling cleaning solutions (see Sections 4.3.8, 4.3.8.2, 4.3.8.2.2, 4.3.8.2.3 and 4.3.8.2.5).

When selecting chemicals for disinfecting and sterilising equipment and installations, BAT is to:

- 14 avoid the use of halogenated oxidising biocides, except where the alternatives are not effective (see Sections 4.3.8.1, 4.5.4.8, 4.5.4.8.1 and 4.5.4.8.2).

5.1.4 Additional BAT for some processes and unit operations applied in a number of FDM sectors

5.1.4.1 Materials reception/despatch

During the reception and despatch of materials, BAT is to do the following:

- 1 when vehicles are parked and during loading and unloading, switch off the vehicle engine and the refrigerator unit, if there is one and provide an alternative power supply (see Section 4.2.1.1).

5.1.4.2 Centrifugation/separation

In all FDM installations carrying out centrifugation, BAT is to do the following:

- 1 operate centrifuges to minimise the discharge of product in the waste stream (see Section 4.2.3.1).

5.1.4.3 Smoking

In all FDM installations carrying out smoking, BAT is to do the following:

- 1 achieve a TOC air emission level of $<50 \text{ mg/Nm}^3$ (see, e.g. Sections 3.3.1.2.2 and 4.4.3.11.1).

5.1.4.4 Frying

In all FDM installations carrying out frying, BAT is to do the following:

- 1 recirculate and burn exhaust gases (see Section 4.2.7.1).

5.1.4.5 Preservation in cans, bottles and jars

In all FDM installations carrying out preservation in cans bottles and jars, BAT is to do the following:

- 1 apply automated can, bottle and jar seasoning filling systems incorporating closed-circuit recycling of spilled liquids (see Section 4.2.8.2)
- 2 use can, bottle and jar cleaning tanks with floating oil recovery when preserving oil, foods canned in vegetable oils or oily foods (see Section 4.2.8.3).

5.1.4.6 Evaporation

In all FDM installations carrying out evaporation, BAT is to do the following:

- 1 use multi-effect evaporators (see Section 4.2.9.1) optimising vapour recompression (see Section 4.2.9.2) related to heat and power availability in the installation, to concentrate liquids.

5.1.4.7 Freezing and refrigeration

In all FDM installations carrying out freezing and refrigeration, BAT is to do the following:

- 1 prevent emissions of substances that deplete the ozone layer by, e.g. not using halogenated substances as refrigerants (see Section 4.1.9.3)
- 2 avoid keeping air conditioned and refrigerated areas colder than necessary (see Section 4.2.15.1)
- 3 optimise the condensation pressure (see Section 4.2.11.2)
- 4 regularly defrost the entire system (see Section 4.2.15.3)
- 5 keep the condensers clean (see Section 4.2.11.3)
- 6 make sure that the air entering the condensers is as cold as possible (see Section 4.2.11.3)
- 7 optimise the condensation temperature (see Section 4.2.11.3)
- 8 use automatic defrosting of cooling evaporators (see Section 4.2.15.5)
- 9 operate without automatic defrosting during short production stops (see Section 4.2.11.7)
- 10 minimise transmission and ventilation losses from cooled rooms and coldstores (see Section 4.2.15.2).

5.1.4.8 Cooling

In all FDM installations carrying out cooling, BAT is to do the following:

- 1 optimise the operation of cooling water systems to avoid excessive blowdown of the cooling tower (see Section 4.1.5)
- 2 install a plate heat-exchanger for precooling ice-water with ammonia, prior to final cooling in an accumulating ice-water tank with a coil evaporator (see Section 4.2.10.1)
- 3 recover heat from cooling equipment. Water temperatures of 50 – 60 °C can be achieved (see Section 4.2.13.5).

5.1.4.9 Packing

In all FDM installations carrying out packing, BAT is to do the following:

- 1 optimise the design of packaging, including the weight and volume of material and the recycled content, to reduce the quantity used and to minimise waste (see Section 4.2.12.2)
- 2 purchase materials in bulk (see Section 4.1.7.2)
- 3 collect packaging material separately (see Section 4.2.12.3)
- 4 minimise overflowing during packing (see Section 4.2.12.6).

5.1.4.10 Energy generation and use

BAT is to do the following:

- 1 for installations where there is a use for the heat and power produced, e.g. in sugar manufacturing, milk powder production, whey drying, instant coffee production, brewing and distilling, use combined heat and power generation in new or substantially altered installations or those renewing their energy systems (see Section 4.2.13.1)
- 2 use heat pumps for heat recovery from various sources (see Section 4.2.13.4)
- 3 switch equipment off when it is not needed (see Section 4.2.13.6)
- 4 minimise the loads on motors (see Section 4.2.13.7)
- 5 minimise motor losses (see Section 4.2.13.8)
- 6 use variable speed drives to reduce the load on fans and pumps (see Section 4.2.13.10)
- 7 apply thermal insulation, e.g. of pipes, vessels and equipment used to carry, store or treat substances above or below ambient temperature and to equipment used for processes involving heating and cooling (see Section 4.2.13.3)
- 8 apply frequency controllers on motors (see Section 4.2.13.9).

5.1.4.11 Water use

If groundwater is used, BAT is to do the following:

- 1 only pump up the quantities of water that are actually required (see Section 4.2.14.1).

5.1.4.12 Compressed air systems

For compressed air generation, BAT is to do the following:

- 1 review the pressure level and reduce it if possible (see Section 4.2.16.1)
- 2 optimise the air inlet temperature (see Section 4.2.16.2)
- 3 fit silencers at air inlets and exhausts, to reduce noise levels (see Section 4.2.16.3).

5.1.4.13 Steam systems

For steam systems, BAT is to do the following:

- 1 maximise condensate return (see Section 4.2.17.1)
- 2 avoid losses of flash steam from condensate return (see Section 4.2.17.2)
- 3 isolate unused pipework (see Section 4.2.17.3)
- 4 improve steam trapping (see Section 4.1.5)
- 5 repair steam leaks (see Section 4.1.5)
- 6 minimise boiler blowdown (see Section 4.2.17.4).

5.1.5 Minimisation of air emissions

Air emissions arise from various sources during processing and cleaning and from the drying of FDM materials.

Process-integrated BAT which minimise air emissions by the selection and use of substances and techniques should be applied. The selection of air emission abatement techniques can then be made, if further control is required.

To prevent air emissions from FDM installations, BAT is to do the following:

- 1 apply and maintain an air emissions control strategy (see Section 4.4.1) incorporating:
 - 1.1 definition of the problem (see Sections 4.4.1.1 and 4.4.1.1.1)
 - 1.2 an inventory of site emissions, including, e.g. abnormal operation (see Sections 4.4.1.2 and 4.4.1.2.1)
 - 1.3 measuring the major emissions (see Sections 4.4.1.3 and 4.4.1.3.1)
 - 1.4 assessing and selecting the air emission control techniques (see Section 4.4.1.4)
- 2 collect waste gases, odours and dusts at source (see Section 4.4.3.2) and duct them to the treatment or abatement equipment (see Section 4.4.3.3)
- 3 optimise the start-up and shut-down procedures for the air emission abatement equipment to ensure that it is always operating effectively at all of the times when abatement is required (see Sections 4.4.3.1)
- 4 unless specified otherwise, where process-integrated BAT which minimise air emissions by the selection and use of substances and the application of techniques do not achieve emission levels of 5 – 20 mg/Nm³ for dry dust, 35 – 60 mg/Nm³ for wet/sticky dust and <50 mg/Nm³ TOC, to achieve these levels by applying abatement techniques. This document does not specifically consider emissions from combustion power plants in FDM installations and these levels are, therefore, not intended to represent BAT associated emission levels from those combustion plants. Some air abatement techniques are described in Sections 4.4 to 4.4.3.12
- 5 where process-integrated BAT do not eliminate odour nuisance, apply abatement techniques. Many of the techniques described in Section 4.4 are applicable to odour abatement.

5.1.6 Waste water treatment

Waste water treatment is an end-of-pipe means of preventing and controlling water pollution. Waste water arises from various sources both as a result of water consumption during processing and cleaning and from the drying of FDM materials.

Process-integrated BAT which minimise both the consumption and the contamination of water should be applied. The selection of waste water treatment techniques can then be made.

No overall conclusions were reached about whether it is better to treat waste water from FDM installations on-site or off-site, except for some primary techniques.

For the treatment of waste water from FDM installations, BAT is to use a suitable combination of the following:

- 1 apply an initial screening of solids (see Section 4.5.2.1) at the FDM installation
- 2 remove fat using a fat trap (see Section 4.5.2.2) at the FDM installation, if the waste water contains animal or vegetable FOG
- 3 apply flow and load equalisation (see Section 4.5.2.3)
- 4 apply neutralisation (see Section 4.5.2.4) to strongly acid or alkaline waste water
- 5 apply sedimentation (see Section 4.5.2.5) to waste water containing SS
- 6 apply dissolved air flotation (see Section 4.5.2.6)
- 7 apply biological treatment. Aerobic and anaerobic techniques applied in the FDM sector are described in Sections 4.5.3.1 to 4.5.3.2
- 8 use CH₄ gas produced during anaerobic treatment for the production of heat and/or power (see Section 4.5.3.2).

Unless otherwise stated in this chapter, the emission levels given in Table 5.1 are indicative of the emission levels that would be achieved with those techniques generally considered to represent BAT (see Section 4.5.1.1). They do not necessarily represent levels currently achieved within the industry but are based on the expert judgement of the TWG.

Parameter	Concentration (mg/l)
BOD ₅	<25
COD	<125
TSS	<50
pH	6 – 9
Oil and grease	<10
Total nitrogen	<10
Total phosphorus	0.4 – 5
Better levels of BOD ₅ and COD can be obtained. It is not always possible or cost effective to achieve the total nitrogen and phosphorus levels shown, in view of local conditions.	

Table 5.1: Typical FDM waste water quality after treatment
[140, World Bank (IBRD), et al., 1998, 199, Finland, 2003]

One MS does not agree with the footnote in Table 5.1, because it believes that deviations from BAT, e.g. due to local conditions, are exclusively allowed to strengthen the requirements of permits.

When further treatment is required to either achieve these levels or to meet special discharge limits, the following techniques are available:

- 9 remove nitrogen biologically (see Sections 4.5.4.1 and 4.5.4.7)
- 10 apply precipitation to remove phosphorus (see Section 4.5.2.9), simultaneously with the activated sludge treatment, where applied (see Section 4.5.3.1.1)
- 11 use filtration for waste water polishing (see Section 4.5.4.5)
- 12 remove dangerous and priority hazardous substances (see Section 4.5.4.4)
- 13 apply membrane filtration (see Section 4.5.4.6).

When the quality of the waste water is suitable for re-use in FDM processing, BAT is to do the following:

- 14 re-use water after it has been sterilised and disinfected, avoiding the use of active chlorine (see Sections 4.5.4.8, 4.5.4.8.1 and 4.5.4.8.2) and which meets the standard of Council Directive 98/83/EC [66, EC, 1998].

The typical application of some waste water treatment techniques in the FDM sector is shown in Table 4.45.

BAT is to treat waste water sludge using one or a combination of the following techniques:

- 15 stabilisation (see Section 4.5.6.1.2)
- 16 thickening (see Section 4.5.6.1.3)
- 17 dewatering (see Section 4.5.6.1.4)
- 18 drying (see Section 4.5.6.1.5), if natural heat or heat recovered from processes in the installation can be used.

BAT has not been identified for the use or disposal of waste water sludges. Some of the available options are listed, but not described in Section 4.5.6.1.

5.1.7 Accidental releases

In general, to prevent accidents and minimise their harm to the environment as a whole, BAT is to do the following:

- 1 identify potential sources of incidents/accidental releases that could harm the environment (see Section 4.6.1)
- 2 assess the probability of the identified potential incidents/accidental releases occurring and their severity if they do occur, i.e. to carry out a risk assessment (see Section 4.6.2)
- 3 identify those potential incidents/accidental releases for which additional controls are required to prevent them from occurring (see Section 4.6.3)
- 4 identify and implement the control measures needed to prevent accidents and minimise their harm to the environment (see Section 4.6.4)
- 5 develop, implement and regularly test an emergency plan (see Section 4.6.5)
- 6 investigate all accidents and near misses and keep records (see Section 4.6.6).

5.2 Additional BAT for some individual FDM sectors

For the sectors for which no additional BAT have been determined, e.g. for grain mill products; dry pasta manufacturing, animal feed manufacturing; breadmaking; confectionery manufacturing; yeast manufacturing; malting; distilling; cidermaking; making soft drinks and making citric acid, the general BAT in Sections 5.1 - 5.1.7 apply.

5.2.1 Additional BAT for the meat and poultry sector

In addition to the BAT in Section 5.1 - 5.1.7, for meat and poultry processing installations, BAT is to do the following:

- 1 thaw meat in air (see Section 4.2.2.5)
- 2 avoid the use of flake ice by using a suitable mixture of chilled and frozen raw materials (see Section 4.7.1.3)
- 3 dose spices and other solid ingredients from a bulk container rather than from plastic bags (see Section 4.1.7.2)
- 4 stop the water supply automatically when sausage fillers and similar equipment are not used at breaks or at production stops (see Section 4.1.8.4).

5.2.2 Additional BAT for the fish and shellfish sector

In addition to the BAT in Section 5.1 - 5.1.7, for fish and shellfish processing installations, BAT is to do the following:

- 1 maintain the quality of fish for optimal use by minimising storage times (see Section 4.1.7.3)
- 2 use high quality fish by ensuring collaboration with upstream suppliers (see Section 4.7.2.3)
- 3 operate regular maintenance programmes (see Section 4.1.5) to, e.g. ensure efficient skinning (see Section 4.7.2.3)
- 4 thaw mackerel, by immersing them in containers filled with water which is mixed by bubbling air through it. The level of the water is maintained by recirculation and using level-actuated switches (see Section 4.2.2.1), achieving a water consumption of ≤ 2 m³/t of raw fish
- 5 thaw whitefish, by immersing them in containers filled with water which is mixed by bubbling air through it. The level of the water is maintained by using level-actuated switches (see Section 4.2.2.2), achieving a water consumption of 1.8 – 2.2 m³/t of raw fish

- 6 thaw shrimps and prawns by immersing them in containers filled with filtered peeling water, if available. The water is mixed by bubbling air through it. The level of the water is maintained by recirculation and using level-actuated switches (see Section 4.2.2.1), or by using level-actuated switches (see Section 4.2.2.2)
- 7 avoid scaling if the fish is subsequently skinned (see Section 4.7.2.7)
- 8 where scaling is undertaken, i.e. where fish is not subsequently skinned, use filtered recirculated scaling waste water for preliminary fish rinsing and properly adjust the scaler operation by weighing the right amount of scales for a specific water flow (see Section 4.7.2.8)
- 9 remove and transport skin and fat from the skinning drum using vacuum suction (see Section 4.7.2.4)
- 10 remove and transport fat and viscera from mackerel by vacuum suction (see Section 4.7.2.5)
- 11 use fine mesh conveyor belts to transport solid products, by-products and wastes, to enable their separation from water (see Section 4.7.2.6)
- 12 when filleting:
 - 12.1 remove the frames from fish fillets by two sets of rotating knives (see Section 4.1.8.8)
 - 12.2 where water nozzles or spray cleaning systems are required, install them with presence-activated sensors (i.e. intermittent operation) (see Section 4.1.8.8).
 - 12.3 a 60 - 75 % reduction in water consumption can be obtained by:
 - 12.3.1 removing unnecessary nozzles so that water is only added where required (see Section 4.1.8.8)
 - 12.3.2 replacing those nozzles that take the fish from the tail cut with a mechanical device (see Section 4.1.8.8)
 - 12.3.3 replacing the nozzles for cleaning the driving wheels on the filleting part with mechanical devices (see Section 4.1.8.8)
 - 12.3.4 replacing existing nozzles by nozzles with a lower water consumption (see Section 4.1.8.8)
 - 12.3.5 using pulsating water nozzles, i.e. alternating the opening and closing of the water supply using an automatic valve (see Section 4.1.8.8)
 - 12.3.6 replacing the waste drain by drain-belts and closing the nozzles in the waste drain. The waste will be separated from the process water directly near the filleting machine, resulting in shorter contact time (see Section 4.7.2.6)
 - 12.4 reduce both the number and size of spray nozzles (water saving of about 75 %) (see Section 4.1.8.8).

5.2.3 Additional BAT for the fruit and vegetables sector

In addition to the BAT in Section 5.1 - 5.1.7, for fruit and vegetable processing installations, BAT is to do the following:

- 1 where storage cannot be avoided, minimise storage times (see Section 4.1.7.3), and where weather conditions do not increase the speed of degradation and/or harm the quality, avoid refrigeration by storing fruit and vegetables and their by-products which are intended for use as animal feed, outdoors in a clean covered area or in containers (see Section 4.7.3.3)
- 2 apply dry separation of rejected raw material from the sorting step and solid residues (e.g. in sorting, trimming, extraction, filtration steps) (see Section 4.1.7.6)
- 3 collect soil in sedimentation and/or filtration steps instead of washing into the WWTP (see Sections 4.1.7.6, 4.5.2.5 and 4.5.4.5)
- 4 peel fruit and vegetables using a batch steam process (see Section 4.7.3.4.2) or a continuous steam process (see Section 4.7.3.4.1) not using cold water to condense the steam and, if for technological reasons steam peeling cannot be applied, use dry caustic peeling (see Section 4.7.3.4.6), unless the recipe requirements cannot be met if either of these techniques is used

- 5 after blanching, cool fruit and vegetables before freezing them by passing them through cold water (see Section 4.7.3.6)
- 6 optimise the re-use of water with or without treatment, depending on the unit operations which require water and the quality of water these require, ensuring that adequate hygiene and food quality standards are maintained (see Section 4.7.3.7).

5.2.4 Additional BAT for the vegetable oils and fats sector

In addition to the BAT in Section 5.1 - 5.1.7, for vegetable oil processing installations, BAT is to do the following:

- 1 use a countercurrent flow desolventiser-toaster in vegetable oil extraction (see Section 4.7.4.2)
- 2 in vegetable oil processing, use the vapour generated in the desolventiser-toaster in the first step of the miscella distillation pre-evaporator (see Section 4.7.4.3)
- 3 use the exothermic reaction heat from the hydrogenation of vegetable oil to heat the product to the desired reaction temperature and to generate steam later in the reaction (see Section 4.7.4.4). The achievable energy (steam) generation is 25 – 125 kWh/t (90 - 450 MJ/t) (40 – 200 kg/t) unrefined oil
- 4 use water ring pumps to generate an auxiliary vacuum for oil drying, oil degassing or minimising oxidation of oil (see Section 4.7.4.11)
- 5 recover hexane from condensable vapours from meal desolventising-toasting, miscella distillation and from the stripping column of the mineral oil system, using a hexane-water gravity separator and a reboiler (see Section 4.7.4.6)
- 6 use a mineral oil scrubber to recover hexane from uncondensable vapours from meal desolventising-toasting, miscella distillation, the reboiler and from the stripping column of the mineral oil system (see Section 4.7.4.5)
- 7 use cyclones, to reduce wet dust emissions arising from vegetable oil extraction, to achieve a wet dust emission level of <math><50 \text{ mg/Nm}^3</math> (see Section 4.7.4.10)
- 8 refine crude oils by physical refining (see Section 4.7.4.7.2), or if they have an ffa content <math><2\%</math>, by chemical refining (see Section 4.7.4.7.1)
- 9 deodorise vegetable oils using a double scrubber in combination with a once-through cooling system (see Section 4.7.4.12.1).

5.2.5 Additional BAT for dairies

In addition to the BAT in Sections 5.1 - 5.1.7, for dairies, BAT is to do the following:

- 1 partially homogenise milk (see Section 4.7.5.3)
- 2 replace batch pasteurisers with continuous ones (see Section 4.7.5.5)
- 3 use regenerative heat exchange in pasteurisation (see Section 4.7.5.6)
- 4 reduce the required frequency of cleaning of centrifugal separators by improving the preliminary milk filtration and clarification (see Section 4.7.5.7)
- 5 use just-in-time “component filling” to avoid losses and minimise water pollution (see Section 4.7.5.12)
- 6 maximise the recovery of diluted, but otherwise uncontaminated, product from CIP initial rinses, HTST start-up, shut-down and change-over and from the rinsing of other equipment and pipework by online detection of transition points between the product and the water phase (see Section 4.7.5.10). This can be done by, e.g. measuring the volume using flow (see Section 4.1.8.4) or density transmitters; measuring the density using conductivity transmitters (see Section 4.1.8.5.2) and using scattered light turbidity sensors (see Section 4.1.8.5.3) to differentiate water from the product
- 7 for large dairies with highly branched tubing, use several small CIP systems instead of a centralised CIP system (see Section 4.3.9)

- 8 re-use cooling water, used cleaning water, condensates from drying and evaporation, permeates generated in membrane separation processes and final rinse-water after the treatment, if any required, to ensure the level of hygiene necessary for the re-use application (see Section 4.7.5.16)
- 9 achieve the levels given in Table 5.2 (see Section 5.2.5.1), Table 5.3 (see Section 5.2.5.2) and Table 5.4 (see Section 5.2.5.5). These are indicative of the levels that can be achieved by applying in-process BAT. They are based on achieved levels reported by the TWG. The ranges reported reflect a variety of conditions under which installations operate. Energy consumption levels may vary due to, e.g. production volumes. Warm climates may use more energy for cooling and *vice versa*. Water consumption and waste water emission levels may vary due to, e.g. different product portfolios, batch sizes and cleaning. The waste water emission level may be lower compared to the water consumption level because many dairies measure the intake of cooling water, often from their own wells, but then discharge it unmeasured. In warm climates water may be lost due to evaporation.

5.2.5.1 Additional BAT for the production of market milk

In addition to the BAT in Sections 5.1 - 5.1.7 and 5.2.5, for the production of market milk, BAT is to do the following:

- 1 achieve the consumption and emission levels shown in Table 5.2 (see Sections 3.3.5.1.1, 3.3.5.1.2, 3.3.5.4 and 5.2.5 paragraph 9)

Energy consumption (kWh/l)	Water consumption (l/l)	Waste water (l/l)
0.07 – 0.2	0.6 – 1.8	0.8 – 1.7

Table 5.2: Consumption and emission levels associated with the production of market milk from 1 litre of received milk

5.2.5.2 Additional BAT for milk powder production

In addition to the BAT in Sections 5.1 - 5.1.7 and 5.2.5, for milk powder production, BAT is to do the following:

- 1 to produce powdered milk use multi-effect evaporators (see Section 4.2.9.1), optimising vapour recompression (see Section 4.2.9.2) related to heat and power availability in the installation, to concentrate liquid milk before spray drying, followed by FDB, e.g. integrated FDB (see Section 4.7.5.8)
- 2 apply an early warning fire alarm, e.g. CO detector, to reduce the risks of explosion in spray driers (see Section 4.7.5.8).
- 3 achieve the consumption and emission levels shown in Table 5.3 (see Sections 3.3.5.1.1, 3.3.5.1.2, 3.3.5.4 and 5.2.5 paragraph 9)

Energy consumption (kWh/l)	Water consumption (l/l)	Waste water (l/l)
0.3 – 0.4	0.8 – 1.7	0.8 – 1.5

Table 5.3: Consumption and emission levels associated with the production of milk powder from 1 litre of received milk

5.2.5.3 Additional BAT for buttermaking

In addition to the BAT in Sections 5.1 - 5.1.7 and 5.2.5, for buttermaking, BAT is to do the following:

- 1 remove residual butter from pipework using a cooled butter block pushed by compressed air (see Section 4.3.4)
- 2 rinse the cream heater with skimmed milk before cleaning it (see Section 4.7.5.13.1).

5.2.5.4 Additional BAT for cheesemaking

In addition to the BAT in Sections 5.1 - 5.1.7 and 5.2.5, for cheesemaking, BAT is to do the following:

- 1 use the heat from warm whey for preheating cheese milk (see Section 4.7.5.14.7)
- 2 maximise whey recovery and use (see Section 4.7.5.14.4)
- 3 segregate salt whey (not to be mixed with sweet or acid whey) (see Section 4.7.5.14.4)
- 4 reduce fat and cheese fines in whey and screen liquid streams to collect fines (see Section 4.7.5.14.2)
- 5 minimise the occurrence of acid whey and drain the top or platform of the salting vats to avoid brine spillage to the WWTP (see Section 4.7.5.14.3)
- 6 to produce whey powder use multi-effect evaporators (see Section 4.2.9.1), optimising vapour recompression (see Section 4.2.9.2) related to heat and power availability in the installation, to concentrate whey before spray drying, followed by FBD, e.g. integrated FDB (see Section 4.7.5.8).

5.2.5.5 Additional BAT for ice-cream manufacturing

In addition to the BAT in Sections 5.1 - 5.1.7 and 5.2.5, for ice-cream manufacturing, BAT is to do the following:

- 1 achieve the consumption and emission levels shown in Table 5.4 (see Sections 3.3.5.1.1, 3.3.5.1.2, 3.3.5.4 and 5.2.5 paragraph 9)

Energy consumption (kWh/kg)	Water consumption (l/kg)	Waste water (l/kg)
0.6 – 2.8	4.0 – 5.0	2.7 – 4.0

Table 5.4: Consumption and emission levels associated with the production of 1 kg of ice cream

5.2.6 Additional BAT for starch manufacturing

In addition to the BAT in Sections 5.1 - 5.1.7, for the starch sector, BAT is to do the following:

- 1 optimise the re-use of process water and/or potato fruit juice in the potato starch making process (see Sections 3.3.7.1, 4.1.6, 4.1.7.6 and 4.7.6.1)
- 2 use gluten process water (in the protein separation step) for germ and fibre washing and steeping processes in maize starch processing (see Section 4.1.7.8)
- 3 wash starch slurry, using a countercurrent flow, before it is dewatered and dried (see Section 4.7.6.1).

5.2.7 Additional BAT for the sugar sector

In addition to the BAT in Sections 5.1 - 5.1.7, for the sugar beet sector, BAT is to do the following:

- 1 recycle transport water (see Section 4.7.7.3)
- 2 use evaporator condensate for sugar extraction from sugar beets (see Section 4.1.7.8)
- 3 avoid drying sugar beet pulp if an outlet is available for pressed sugar beet pulp, e.g. animal feed; otherwise dry sugar beet pulp using steam driers (see Section 4.7.7.1.4) or using high temperature driers (see Section 4.7.7.1.2), combined with measures to reduce emissions to air. In HTD possible measures to reduce emissions to air include, e.g. minimising the quantity of small beet particles dried, drying to a maximum dry matter content of 91 %, mechanical pressing of pulp prior to drying, minimising the quantity of added mollasses before drying and optimising the operation of cyclones (see Section 4.4.3.5.2) and spray scrubbers (see Section 4.4.3.5.3).

5.2.8 Additional BAT for the coffee sector

In addition to the BAT in Sections 5.1 - 5.1.7, for the coffee sector, BAT is to do the following:

- 1 when roasting coffee, recirculate air from the roaster back into the roaster (see Section 4.7.8.4.1)
- 2 when roasting coffee, where process-integrated BAT which minimise air emissions by the selection and use of substances and the application of techniques do not achieve emission levels of 5 – 20 mg/Nm³ for dry dust; <50 mg/Nm³ TOC for light roasted coffee (this level is more difficult to achieve as the darkness of roasting is increased, see Section 3.2.39.2); to achieve these levels by applying abatement techniques. Some air abatement techniques are described in Sections 4.4 to 4.4.3.12. Emission levels for NO_x were provided too late for full verification by the TWG, these are reported in Section 7.5 of the Concluding remarks chapter
- 3 in instant coffee manufacturing, use the waste heat from the hot liquid coffee extract to heat the process water prior to extraction and use countercurrent heat-exchange to use the heat from spray drying within the roasting sector (see Section 4.7.8.1)
- 4 during instant coffee manufacturing, after drying, agglomerate the dust to make granules then recycle the remaining dust and apply air abatement (see Section 4.7.8.2).

5.2.9 Additional BAT for drinks manufacturing

In addition to the BAT in Sections 5.1 - 5.1.7, for drinks processing installations, BAT is to do the following:

- 1 if CO₂ is used in the installation, use CO₂ which is either recovered from the fermentation process or as a by-product of another process, to avoid the production of CO₂ directly derived from fossil fuels especially for use in the installation (see Section 4.2.4.1)
- 2 recover yeast after fermentation (see Section 4.7.9.3)
- 3 where diatomaceous earth is used as a filter, collect the spent filter material to optimise re-use and/or disposal (see Section 4.7.9.4.3)
- 4 use multistage bottle cleaning systems (see Section 4.7.9.5.2)
- 5 optimise water consumption of the rinsing zone in the bottle cleaning machine, by controlling the rinsing water flow, installing an automatic valve to interrupt the water supply in case the line stops and using fresh water for the two last rows of rinsing nozzles (see Section 4.7.9.5.4)
- 6 re-use bottle cleaning overflows after sedimentation and filtration (see Section 4.7.9.5.3).

5.2.9.1 Additional BAT for brewing

In addition to the BAT in Sections 5.1 - 5.1.7 and 5.2.9, for breweries, BAT is to do the following:

- 1 optimise the re-use of hot water from wort cooling (see Section 4.7.9.6.4) and recover heat from wort boiling (see Section 4.7.9.6.5)
- 2 re-use bottle pasteurising overflow water (see Section 4.7.9.5.5)
- 3 achieve a water consumption level of 0.35 – 1 m³/hl of beer produced (see Section 3.3.11.1).

5.2.9.2 Additional BAT for winemaking

In addition to the BAT in Sections 5.1 - 5.1.7 and 5.2.9, for winemaking, BAT is to do the following:

- 1 after the cold stabilisation of wine, re-use the alkaline cleaning solution (see Section 4.7.9.8.1) and when the spent alkaline solution can no longer be re-used and the pH is still high enough to disrupt the operation of the WWTP, apply self-neutralisation (see Section 4.5.2.4) or if the pH levels and the flowrate will not disrupt the operation of the WWTP, gradually release the cleaning solution to the WWTP (see Section 4.7.9.8.2).

6 EMERGING TECHNIQUES

This chapter includes novel pollution prevention and control techniques that are reported to be under development and may provide future cost or environmental benefits. If available, the information includes the potential efficiency of the techniques, a preliminary cost estimate, and an indication of the time-scale before the techniques might be commercially “available”. Established techniques in other sectors that are emerging in practice within the FDM sector are not included.

6.1 Use of UV/ozone in absorption for odour abatement

Description

Ozone has been used historically as an oxidant in only a limited number of odour control applications. This is primarily because, although it is extremely reactive in the liquid phase, its reactivity in the gaseous phase is lower. A process was developed during the 1980s that enhanced the activity of ozone by the incorporation of UV light. The process uses a conventional packed bed system and a liquid recycle system. Ozone is bubbled into the sump of the absorber and the ozonated water is passed through a bank of UV lamps. Ozone in the presence of UV light produces hydroxyl radicals which are far more reactive than ozone alone. Dissolved organic compounds in the liquid phase are oxidised to carbon dioxide and water and thus the absorber liquor discharged from the system is relatively clean.

Achieved environmental benefits

Reduced odour emissions.

Applicability

Ozone systems have not been effective when applied to hot and humid airflows, e.g. when applied to a poultry processor scald tank vent.

Reference literature

[34, Willey A R and Williams D A, 2001]

7 CONCLUDING REMARKS

7.1 Timing of the work

The work on this document started with the first plenary meeting of the TWG in January 2001. The main issues discussed at this meeting were the scope of this document; the key environmental issues; how to approach the work in such a diverse sector and the identification of information required. A deadline was agreed for providing the information, i.e. in time to be included in the first draft.

The discussion about the scope led to the definition of the upstream and downstream boundaries, based on the activities listed in the Directive and the issues within the scope of other BREFs in the series. The inclusion or exclusion of sectors in this document does not, however, infer any interpretation of the Directive. For example, the discussions revealed that in some MS languages the term “food” includes animal feed and in others it does not. After some discussion, a decision was made to include the processing of animal feed in this document. Further discussions with the “Slaughterhouses and animal by-products” TWG, led to the production of petfood of animal origin being included in the scope of this document. The documents do not seek to interpret the Directive, so issues related to production capacities and decisions about where permits are required are not covered.

A first draft was issued to the TWG, for consultation, in April 2002. The consultation period lasted approximately 8 weeks. A second draft, including the proposed BAT conclusions, was sent to the TWG in May 2003. The consultation period lasted until August 2003. In September 2003, the original author left the EIPPCB and in November 2003, a new author took over the work on this document.

During 2004, the work concentrated on taking account of the comments on the second draft; developing the presentation of the information to the reader and consolidating the BAT conclusions, ensuring that they were cross-referenced to the supporting information in this document.

The final plenary meeting of the TWG was held in February 2005. The meeting concentrated on discussing the BAT conclusions and the information supporting them in this document.

After the final meeting, the BAT chapter was modified to show the changes agreed at the meeting. The “Concluding remarks” and the “Executive summary” chapters were then drafted, followed by short consultations, after which the final redrafting took place.

The wide diversity of the FDM sector has presented a special challenge to the TWG. A huge variety of raw materials are processed. Many similar products are processed in different ways, sometimes following regional recipes and many dissimilar products are processed in similar ways. The wide scope of the sector; the ongoing provision of information late in the process and the change of author all influenced the content and the preparation time of this document.

7.2 Level of consensus, driving forces and issues arising from the final TWG meeting

The conclusions of the work were agreed at the final plenary meeting, with a high level of consensus being achieved. Most of the BAT are concerned with the management and operation of FDM processing. The application of most of the BAT, therefore, requires little or no investment in equipment. These “in-process BAT” can generally deliver cost savings because of improved efficiencies and reduced waste production. The emphasis on the prevention of pollution by the application of “in-process” BAT may result in minimising the amount of investment required to apply “end-of-pipe” BAT, by, e.g. reducing the scale to which it is required. For example, minimising the quantity of water used and reducing its contamination with food particles and detergents, by carrying out dry cleaning, can reduce the requirement for waste water treatment compared to hosing food from equipment and floors into drains.

The nature of the raw materials in the FDM sector and the importance of freshness, both for product quality and to prevent waste, makes collaboration between upstream and downstream partners important. It was agreed that “BAT is to seek collaboration with upstream and downstream partners, to create a chain of environmental responsibility, to minimise pollution and to protect the environment as a whole”. This is consistent with the BAT approach, not only at a site-specific level, but also on a wider scale and it may be achieved at installation level or on a wider scale via organisations representing the FDM sector.

Maintenance of acceptable hygiene standards is critical in FDM installations to guarantee product quality and food safety. This strict hygiene control and the consequent requirement for regular and frequent cleaning of FDM installations and equipment have greatly influenced the BAT conclusions, especially those related directly to cleaning. Also, the recipes of some products have influenced the environmental considerations as the application of some techniques may be necessary to ensure a certain flavour, aroma or texture and this may make other techniques inapplicable.

One split view was registered. One MS does not agree with the footnote in Table 5.1, which shows FDM waste water quality after treatment. The footnote states that “Better levels of BOD₅ and COD can be obtained. It is not always possible or cost effective to achieve the total nitrogen and phosphorus levels shown, in view of local conditions”. The MS believes that deviations from BAT, e.g. due to local conditions, are exclusively allowed to strengthen the requirements of permits.

There were some discussions arising from new information introduced during the meeting. These are discussed in Section 1.5, which contains recommendations for further work.

When the BAT associated level for dry dust emissions from FDM installations was discussed at the final plenary meeting, the question of whether this applied to emissions from combustion power plants in FDM installations was raised. Emissions from combustion power plants had not been a subject of the information exchange before the final meeting, so it was made clear that the BAT associated emission levels are not intended to represent BAT from such combustion plants.

7.3 Information provided

The TWG comprises 16 MSs and the FDM industries also form a large proportion of the group. Many of the TWG members from industry are part of the CIAA delegation. Some of the TWG members from MSs also include industry representatives. Equipment suppliers are also represented. The environmental NGOs did not participate in the work on this document.

Many reports from MSs and industry were used as sources of information in the drafting of this document, including information from example plants. The participation of individual MSs in the work, to an extent, reflected the regional distribution of the sectors. For example, several MSs participated in the work on dairies, with notable contributions from the Nordic states [42, Nordic Council of Ministers, et al., 2001], Germany [9, Verband der Deutschen Milchwirtschaft (German Dairy Association), 1999] and Italy [75, Italian contribution, 2002]. Greece, Italy, Portugal and Spain dominated the discussions about olive oil. Italy provided all of the information about pasta. Germany was one of the most active members in the information exchange process. Much of the information provided by Germany was the result of close collaboration between the German authorities and some individual FDM sectors [65, Germany, 2002], e.g. the vegetable oil and fats, dairy and brewing sectors.

CIAA and its member organisations provided most of the industry contributions. These included information about the majority of the individual FDM sectors, with the exceptions of meat; fish and shellfish, and fruit and vegetables. There is relatively little information specifically about the meat sector in this document and most of this was provided by the Nordic states [41, Nordic Council of Ministers, 2001] and Italy [89, Italian contribution, 2001, 91, Italian contribution, 2001]. The information about fish and shellfish processing came mainly from the Nordic states [28, Nordic Council of Ministers, 1997]. The main sources of information about fruit and vegetable processing were Belgium [31, VITO, et al., 2001, 32, Van Bael J., 1998] and Italy [89, Italian contribution, 2001, 91, Italian contribution, 2001].

The importance of hygiene throughout the whole FDM sector is shown by the fact that information and comments about cleaning came from several MSs and from CIAA.

Most of the information about air abatement techniques was provided by CIAA [34, Willey A R and Williams D A, 2001] and Germany [65, Germany, 2002], although this contained relatively little information about emission levels or about the application or applicability of the techniques in the overall FDM sector or the individual sectors.

A high proportion of the information about waste water and its treatment was provided by the UK [13, Environment Agency of England and Wales, 2000] and Germany [65, Germany, 2002]. Information about waste water treatment in individual sectors was provided by various MSs and industry.

Information was also gathered during site visits made during the period 2001 – 2003, i.e. before the second draft was completed. The sites visited included two dairies, one in Hungary and one in Germany; four breweries, one in Hungary, one in Finland and two in Spain; a sugar refinery in Finland; a meat processing installation in Spain; two champagne installations in France, a sugar installation practising landspreading in France and several olive oil producers in Spain. Several meetings were held with CIAA on behalf of its members. Meetings were also held with German, Finnish and Spanish TWG members and with the Brewers of Europe.

The formal consultations on the draft document also prompted the submission of a huge amount of information, relatively late in the process instead of, as requested, before the first draft. The consultations provided the main opportunities for the TWG to verify information already submitted.

Almost half of the TWG members attended the final plenary meeting. The MSs on the FDM TWG were well represented at the final plenary meeting and were active in the discussions. The industry representatives were also active. A high proportion of the industry delegation represented the sugar sector.

The information exchange and the preparation of this document has been a positive development in the prevention and control of pollution for the sectors concerned. It has provided a first-time opportunity for individual sectors to learn about techniques that have been proven to work well in others, on a Europe-wide scale. The structure of this document promotes this understanding, by focusing on the processes and practices that are common for all or many of the FDM sectors and describing their application and applicability. For example, some techniques reported for the canning of fish were recognised as being applicable for preservation in cans, bottles and jars and for foods other than fish. Consequently, some techniques originally reported for individual sectors, have been determined to be BAT in others.

7.4 Information imbalances and gaps

In general, there is a vast difference in the level of detail of information provided about individual FDM sectors and there are also differences in the coverage of the key environmental issues in this document.

Many of the gaps which exist may be symptomatic of the fact that before the integrated approach was applied to regulating the environmental performance of the FDM sector less monitoring was carried out, particularly of in-process consumption and emission levels. The need for more information, to identify and prioritise where improvements in performance are required and to monitor improvements, is acknowledged.

For example, there is a very low level of quantitative data about meat processing, which is a major FDM sector with installations in all of the MSs. In contrast, this document contains a lot of detail about fruit and vegetable processing, however, most of this is reported as current consumption and emission data without explanations about what in-process and/or end-of-pipe techniques were applied to achieve the levels measured.

In general, the current consumption and emission level data provided were not linked with process descriptions, operating conditions, installation capacity, sampling and analytical methods and statistical presentations. For example, for waste water, information about contaminant levels from unit operations could help to identify areas where in-process controls could be improved, whereas levels measured after mixing water from various sources, after partial or complete on-site waste water treatment, does not. Reported variations in current consumption and emission levels may reflect, e.g. variations in products and processes or differences in the application of preventive techniques. Many of the techniques have been assessed qualitatively and, due to insufficient explained data, very few BAT associated consumption and emission levels have been concluded. BAT associated levels provide useful performance levels that can be used to monitor the application of BAT. They also contribute to the consistency of permit conditions.

Energy consumption is a key environmental issue in the FDM sector, e.g. for processing operations which involve the application or removal of heat and for cold storage, to maintain freshness and to ensure food safety. Techniques which can reduce energy consumption are described in this document, but very few actual measurements of energy savings associated with the application of those techniques or about the economics of investing in techniques and the resultant cost savings were provided. Such information is helpful at installation level, when considering what techniques to apply.

Benchmarks for waste minimisation are not provided, e.g. there is no detailed information about what proportion of specified raw materials end up being used in products or by-products. The industries concerned use the terms “product”, “by-product” and “co-product”. For the purposes of identifying BAT, it is more helpful to distinguish between materials which are used and others which are disposed of as waste. The nature of the FDM sector, i.e. the production of food for human and animal consumption means that the minimisation of waste necessarily takes into consideration the important issues of hygiene, food quality and customer preferences.

Water consumption and, therefore, the recycling and re-use of water were identified as key issues in the FDM sector. Although some data were provided, these were not always well explained, e.g. it was not stated whether some water consumption data for powdered milk production, included cooling water and if so, if it is once-through or recirculated. The principles of how far water should be treated, e.g. to achieve an acceptable standard for specified re-use, or to make it drinking water standard and usable in all applications, is not dealt with well in this document as an FDM generic issue. Some detailed information about water re-use is given for fruit and vegetable processing and for dairies.

The legislative requirements and practical solutions to some environmental problems are acknowledged to be changing rapidly, e.g. with respect to the use of substances which contribute to global warming. These include some refrigerants. Further information is available on <http://www.fluorocarbons.org/>.

7.5 Recommendations for future work

Although the information exchange has provided an opportunity for learning which has not existed in the past, there are some gaps remaining in the information and future work could provide results which might assist in the identification of BAT when this document is reviewed. By taking such additional information into consideration, this could help installation operators and permit writers to protect the environment as a whole. This section contains recommendations for future work, both at the overall FDM sector level and at individual sector level.

Much of the data in this document are not well explained and this makes it difficult to use to compare techniques and monitor improvements. It is recommended that when consumption and emission level data are provided for the review of this document, that it be linked with process descriptions, operating conditions, sampling and analytical methods, and statistical presentations. Information provided at unit operation level would enable installation operators and permit writers to apply BAT throughout the process and minimise the amount of end-of-pipe treatment required. Examples of these gaps are mentioned in Section 7.4.

The identification of BAT for the first extraction of olive oil was discussed. The technique “Two-phase extraction of olive oil” is described in Chapter 4. This technique is widely applied and there are reported environmental benefits. After a discussion at the meeting, the TWG decided that it could not reach a conclusion about BAT for olive oil extraction. In view of the environmental impact of olive oil extraction and the recent very wide application of this technique, it is recommended that the relevant information is provided to enable a full discussion when this document is reviewed.

The issue of NO_x emissions from coffee roasting was raised at the final plenary TWG meeting, for the first time in the information exchange. New information about NO_x emission levels of 350 mg/Nm³ for decaffeinated coffee and 700 mg/Nm³ for regular coffee were introduced and proposed as BAT. Due to this issue being raised so late in the work, it was not possible for the TWG to consider whether such apparently high emission levels could be BAT and to report or comment on how they are achieved. It was reported that NO_x emissions from coffee roasting is a recognised problem and that levels of 3000 mg/Nm³ are emitted, unabated, from some installations. Due to the lateness in the process and the incomplete information, no BAT or BAT associated levels could be determined for minimising NO_x emissions from coffee roasting installations.

It is recommended that the issue of NO_x emissions from coffee roasting installations be fully considered when this document is reviewed. This will require information to be provided about the techniques used in existing installations with the range of emission levels reported, so that techniques for achieving the lower levels can be identified. This should include an explanation about the differences between the roasting of regular coffee and decaffeinated coffee. Also, due to the lower levels being so high, the further reduction of NO_x emission levels from coffee roasting installations is a suggested research topic (see Section 7.6).

The risks associated with the use of EDTA have been assessed by the European Chemicals Bureau [256, European Communities European Chemicals Bureau, 2004]. The report of the risk assessment refers to the total European market for EDTA and states “A high level of usage is the dairy and drinks industry, with 50 % of the total reported tonnage”. The report discusses removal rates for some on-site WWTPs and some MWWTPs. It concludes “There is a need for limiting the risks; risk reduction measures which are already being applied shall be taken into account. This conclusion is reached because of the high emissions due to the use of EDTA in industrial detergents. The exposure near sites within dairy and beverage industry with no effective EDTA removal in their treatment plants is expected to lead to a risk for aquatic organisms”. The report then also mentions other industrial sources of EDTA emissions to water.

During the information exchange, the use of EDTA and its emission to water was acknowledged to be an ongoing problem in the FDM sector. The TWG agreed that it is BAT to minimise the use of EDTA. Throughout the work, the TWG reported that for some applications there are no known effective substitutes which can be used to completely eliminate the use of EDTA and that the effectiveness and environmental impact of some potential substitutes had not been adequately assessed. During the final TWG meeting, it was reported that EDTA is not used in dairies in the UK. The possibility of determining BAT to eliminate the use of EDTA could be greatly helped if information about alternative substances already in use was provided and research into other alternatives was undertaken, before this document is reviewed.

A number of activities, particularly in relation to vegetable processing, are seasonal. Some members of the TWG have expressed concern about the application of generic BAT to seasonal activities, due to different economic standards, although specific information about these difficulties was not provided. This issue is not well covered in this document. Information about seasonal activities should be collected in the future.

Some information was provided by the TWG after the consultation period when it was too late to take it into account. For example, late information was received about enzymatic degumming of vegetable oils and fats and enzymatic interesterification of fully hydrogenated vegetable oils and fats. Such information can be considered when this document is reviewed. It is recommended that degumming of vegetable oils be fully appraised when this document is reviewed. The TWG discussed the use of either citric acid or phosphoric acid, particularly with reference to their relative impacts on the final phosphorus content of treated waste water and their economic viability. The TWG did not reach a conclusion about which technique is BAT.

Other issues have been raised during the information exchange, but not fully appraised. It is recommended that information be provided about these for discussion when this document is reviewed. These issues include:

- as a general principle, a wider examination of the applicability of techniques reported to be applied in one sector that could be carried out in other sectors. This would optimise the opportunity for sectors to learn from each other. For example, pigging was reported for use in jam making, but it is already widely applied in the FDM sector and may be applicable as a dry cleaning technique in other FDM sectors, for which it has not yet been considered
- identification of more opportunities for by-product valorisation, to optimise the use of food, drink and milk materials and to minimise waste generation
- economic information about the costs of investing in and operating techniques and the associated direct and indirect savings, e.g. due to reduced energy or waste disposal costs, or reduced losses from unintentional losses due to leakage or spills
- identification of BAT associated with high, medium and low pressure cleaning. The TWG were unable to determine which of these techniques is BAT. Increasing the pressure can remove solid residues by physical force and potentially reduce the consumption of hot and cold water and detergents. Increasing the pressure also increases the aerosol levels produced and this can cause hygiene problems, particularly if it is necessary to carry out cleaning during production
- although many air abatement techniques are described in this document, there is very little information about their application and applicability in the FDM sector

- the application of non-thermal plasma treatment of odours in the FDM sector. There are some outstanding concerns about the reliability and performance of this technique and possible safety concerns when the technique is used to treat airstreams which may cause a fire and explosion hazard
- the production of non-alcoholic beer may result in very high discharges of condensed alcohol into the WWTP. Techniques to prevent such discharges are not described in this document
- fumigation as a source of possible fugitive emissions, e.g. the selection and use of fumigants.

7.6 Suggested topics for future R&D projects

The information exchange has also identified some areas where additional useful knowledge could be gained from research and development projects. These relate to the following subjects:

- some malodorous substances emitted from FDM installations are acknowledged to be harmful to the environment because, e.g. they contain VOCs. Parts of industry consider that odours in general should be considered as causing nuisance only and could be dispersed without treatment to destroy the malodorous substance. Malodorous emissions can comprise a complex mixture of unidentified substances, so it is difficult to assess the adequacy of abatement techniques. Research into the composition and harmfulness of emissions would therefore be helpful
- the lowest levels of NO_x emissions reported from coffee roasting are very high (see Section 7.5). The identification of techniques for consideration in the determination of BAT for minimising NO_x levels from coffee roasting installations is a suggested research topic
- alternatives to using EDTA as a cleaning agent
- the environmental benefits and costs of reverse osmosis. RO is reported as being widely used in the FDM sector, e.g. for concentration of whey, skimmed milk and fruit juices; for polishing NF permeates or evaporator condensate and in water treatment, e.g. softening and for the removal of both salt and phosphorus. The technique is reported to be effective. Its cross-media effect of high energy consumption and the cost of cleaning and replacing filters make it expensive to operate. The TWG did not reach any BAT conclusions either supporting or opposing the use of RO. Research into its environmental benefits, its cross-media effects and its economic viability would provide useful information for when this document is reviewed.

The EC is launching and supporting, through its RTD programmes, a series of projects dealing with clean technologies, emerging effluent treatment and recycling technologies and management strategies. Potentially these projects could provide a useful contribution to future BREF reviews. Readers are therefore invited to inform the EIPPCB of any research results which are relevant to the scope of this document (see also the Preface of this document).

8 REFERENCES

- 1 CIAA (2002). "CIAA Background Document for the Technical Working Group on the "Food and Drink" BAT Reference Document Rev. 7".
- 2 Meyer, J.; Kruska, M.; Kuhn, H.-G.; Sieberger, B.-U. and Bonczek, P. (2000). "Rationelle Energienutzung in der Ernährungsindustrie", Friedr. Vieweg & Sohn, 3-528-03173-5.
- 3 CIAA (2001). "Status Report on Food Legislation in the European Union".
- 5 Derden A Vercaemst P and Dijkmans R (1999). "Beste Beschikbare Technieken voor de groente-en fruitverwerkende nijverheid", Vlaamse BBT-Kenniscentrum VITO.
- 9 Verband der Deutschen Milchwirtschaft (German Dairy Association) (1999). "Bonn, 1999, translation of extracts and additions made 2001", VDM.
- 10 Environment Agency of England and Wales (2000). "Process Descriptions for the Food and Drink sector".
- 11 Environment Agency of England and Wales (2000). "BAT and Waste Minimisation in Food and Drink Sector", Environment Agency.
- 13 Environment Agency of England and Wales (2000). "IPPC Best Available Techniques (BAT) for Effluent Management in the Food & Drink Sector".
- 17 Envirowise (UK) and March Consulting Group (UK) (1998). "ETBPP: Reducing the Cost of Cleaning in the Food and Drink Industry Guide - GG 154", Environmental Technology Best Practice Programme, <http://www.etsu.com/etbpp>.
- 18 Envirowise (UK) & Entec UK Ltd (1999). "ETBPP: Low-Cost Process Control in Food and Drink Processing - Guide GG 220", Environmental Technology Best Practice Programme, <http://www.etsu.com/etbpp>.
- 23 Envirowise (UK) and Dames & Moore Ltd (1998). "ETBPP: Reducing the Water and Effluent Costs in Breweries - Guide GG 135", Environmental Technology Best Practice Programme, <http://www.etsu.com/etbpp>.
- 27 ATV (2000). "ATV Handbuch Industrieabwasser, Lebensmittelindustrie, 4. Auflage", Ernst Sohn Verlag, ISBN 3-433-01467-1.
- 28 Nordic Council of Ministers (1997). "BAT Best available technology in the fishing industry", Nordic Council of Ministers and Nordic Council,, TemaNord 1997:579.
- 31 VITO; Derden, A.; Vercaemst, P. and Dijkmans, R. (2001). "Best Available Techniques (BAT) for the fruit and vegetable processing industry", VITO.
- 32 Van Bael J. (1998). "Memorandum on Energy Consumption in the Flemish Frozen Vegetable Sector", VITO.
- 34 Willey A R and Williams D A (2001). "Management of Odorous Emissions in the Food Industry".
- 35 OECD (2001). "The Application of Biotechnology to Industrial Sustainability", OECD.
- 37 Environment Agency of England and Wales (2000). "BAT for Cleaning. Extract from UK Interim National BAT Guidance for the Food and Drink Sector".

References

- 39 Verband der Deutschen Milchwirtschaft (German Dairy Association) (2001). "Comments on the first draft and associated additional information and personal communications", personal communication.
- 41 Nordic Council of Ministers (2001). "Best Available Techniques (BAT) in Nordic Slaughterhouses", TemaNord 2001:553.
- 42 Nordic Council of Ministers; Korsström, E. and Lampi, M. (2001). "BAT for Nordic dairy industry", TemaNord 2001:586.
- 43 Envirowise (UK) and Entec UK Ltd. (1999). "ETBPP: Reducing Waste for Profit in the Dairy Industry - Guide GG 242", Environmental Technology Best Practice Programme, <http://www.etsu.com/etbpp>.
- 45 Envirowise (UK) and Ashact (2001). "ETBPP: Reducing Water and Waste Costs in Fruit and Vegetable Processing - Guide GG 280", Environmental Technology Best Practice Programme, <http://www.etsu.com/etbpp>.
- 47 Envirowise (UK) and Aspinwall & Co. (1999). "ETBPP: Reducing the Cost of Packaging in the Food and Drink Industry - Guide GG 157", Environmental Technology Best Practice Programme, <http://www.etsu.com/etbpp>.
- 51 Envirowise (UK) (1998). "ETBPP: Water use in the Soft Drink Industry - Guide EG 126", Environmental Technology Best Practice Programme, <http://www.etsu.com/etbpp>.
- 52 Envirowise (UK) (2000). "ETBPP: Turning Waste into Profit - Case Study GC 150", Environmental Technology Best Practice Programme, <http://www.etsu.com/etbpp>.
- 57 Envirowise (UK) (2000). "ETBPP: Pigging Cuts Costs, Recovers Product and Reduces Effluent - Case Study GC 261", Environmental Technology Best Practice Programme, <http://www.etsu.com/etbpp>.
- 58 Envirowise (UK) (1999). "ETBPP: Cutting Water and Effluent Costs in Fish Processing - Case Study GC 202", Environmental Technology Best Practice Programme, <http://www.etsu.com/etbpp>.
- 59 Danbrew Ltd. (1996). "Environmental Management in the Brewing Industry", UNEP Industry and Environment, 92-807-1523-2.
- 60 Environment Agency of England and Wales (1998). "Money for nothing - your waste tips for free", Environment Agency.
- 61 CEFS (2001). "Guide to establishing BAT in the sugar industry", CEFS.
- 62 Envirowise (UK); EEF and Lloyds Bank (1998). "ETBPP: Waste minimisation pays: Five business reasons for reducing waste - GG 125", Environmental Technology Best Practice Programme, <http://www.etsu.com/etbpp>.
- 63 Envirowise (UK) and William Battle Associates. (1998). "ETBPP: Cutting costs by reducing waste: Running a workshop to stimulate action - GG 106", Environmental Technology Best Practice Programme, <http://www.etsu.com/etbpp>.
- 64 Environment Agency of England and Wales (2001). "Waste Minimisation - An Environmental Good Practice Guide For Industry".

- 65 Germany (2002). "Best Available Techniques Reference Document on the Food and Milk Industry", BMU, Hannover University, fdm/tm/65.
- 66 EC (1998). "Council Directive 98/83/EC on quality of water intended for human consumption", European Commission.
- 67 EC (2001). "Integrated Pollution Prevention and Control (IPPC) Reference Document on the Application of Best Available Techniques to Industrial Cooling Systems".
- 68 European confederation of organisations for testing, i., certification and prevention, (1984). "Requirements for boiler water and boiler feed water - R 54/CEOC/CP 84 Def".
- 69 Environment Agency of England and Wales (2001). "Integrated pollution prevention and control Energy efficiency - IPPC H2", Horizontal Guidance Note.
- 70 UNEP; Danish EPA and COWI (2000). "Cleaner Production Assessment in Dairy Processing", 92-807-1842-8.
- 73 CADDET UK National team (1997). "Advanced control techniques improve drying energy performance", Caddet Energy Efficiency Newsletter No.4, <http://www.caddet-ee.org/>.
- 74 Greek Ministry for the Environment, P. P. a. P. W., General Direction for the Environment, Air Pollution and Noise Control Directorate, Industrial Pollution Control Division (2001). "Food industry IPPC study".
- 75 Italian contribution (2002). "BAT candidates for dairy industry", personal communication.
- 79 Italian contribution (2001). "Dairy industry - General information", personal communication.
- 81 France (2001). "The application of effluents from the food, drink and milk industries to land", personal communication.
- 82 BMU and German Federal Ministry for Environment Nature Conservation and Reactor Safety (1986). "Technische Anleitung zur Reinhaltung der Luft vom 27 Februar 1986".
- 83 CIAA (2001). "Comments on dairy industry for the UK Document - fm No.13".
- 84 European Starch Association (2001). "Comment on the UK Document Process descriptions - fm No.10".
- 85 Environment Agency of England and Wales (2000). "BAT note on frying", personal communication.
- 86 Junta de Andalucia and Agencia de Medio Ambiente (1994). "Sistemas de obtencion de aceite de oliva sin produccion de alpechin. Situacion actual".
- 87 Ullmann (2001). "Encyclopedia of Industrial Chemistry", Wiley-VCH Verlag GmbH.
- 89 Italian contribution (2001). "Consumption & emission data for meat and fruit and vegetables sectors", personal communication.
- 90 EC (2002). "Directive of the European Parliament and of the Council on the promotion of cogeneration based on a useful heat demand in the internal energy market, COM(2002) 415 final", OJ.

References

- 91 Italian contribution (2001). "Fruit & vegetable and meat processing. General information and applied technologies", personal communication.
- 92 CADDET Energy Efficiency (2000). "Saving energy with cogeneration in a brewery", CADDET Energy Efficiency Newsletter, http://www.caddet-ee.org/nl_pdf/003_08.pdf.
- 93 EC (2000). "Guidance Document for EPER implementation", European Commission, 92-894-0279-2.
- 94 Environment Agency of England and Wales (2002). "UK comments to the first draft".
- 95 EC (2005). "Integrated Pollution Prevention and Control (IPPC) Reference Document on Best Available Techniques on Emissions from Storage".
- 96 EC (2003). "Integrated Pollution Prevention and Control (IPPC) Reference Document on the General Principles of Monitoring,".
- 99 Germany (2002). "Comments to the first draft".
- 102 UK (2002). "Comments to the first draft".
- 109 CIAA-FEDIOL (2002). "Comments to the first draft - vegetable oil".
- 115 CIAA-AAC-UFE (2002). "Comments to the first draft - starch".
- 117 CIAA-UNAFPA (2002). "Comments to the first draft - pasta".
- 118 CIAA-EDA (2002). "Comments to the first draft - dairy".
- 124 Italy (2002). "Comments to the first draft - fruit and vegetable".
- 125 Boehm, E.; Hillenbrand, T.; Herrchen, M. and Wahle, U. (2002). "Comprehensive preliminary studies and proposals for measures of risk reduction strategies for EDTA", Fraunhofer Institute.
- 126 Knepper, T. P. and et al. (2001). "Eintrage synthetischer Komplexbildner in die Gewasser", ESWE Institut for Wasserforschung, FKZ 299 24 284.
- 127 Strohmaier (2002). "Moderne Produktionstechniken and Technologien zur Herstellung von Molkenderivativen", personal communication.
- 128 CADDET Energy Efficiency (1992). "Quadruple-effect milk evaporator uses mechanical vapour recompression", IEA, OECD, <http://www.caddet-ee.org/>.
- 134 AWARENET (2002). "Tools for prevention and minimisation of agro-food wastes generation in European industry (This working draft is no longer available)", GRD1-CT-2000-28033.
- 136 CBMC - The Brewers of Europe (2002). "Guidance Note for establishing BAT in the brewing industry", CBMC.
- 139 Nielsen E.H. Lehmann, M. (2002). "BAT in the Danish sugar industry".
- 140 World Bank (IBRD); UNEP and UNIDO (1998). "Pollution prevention and abatement handbook - Toward cleaner production", World Bank, Washington, USA, http://www-wds.worldbank.org/servlet/WDS_IBank_Servlet?pcont=details&eid=000094946_99040905052283, D:\....\WB_cleanprod.pdf.

- 141 FEDIOL (2002). "Candidate BATs", personal communication.
- 142 IMPEL (2002). "Compilation of data on the Olives Processing Sector, with emphasis on the EU Mediterranean countries", Working document prepared in the EU IMPEL Olive Oil Project, personal communication.
- 143 CADDET Energy Efficiency (1997). "Air treatment in a cheese warehouse", twgfood\caddet_cheese_air.html.
- 145 Metcalf & Eddy (1991). "Wastewater engineering - Treatment, disposal and reuse, 3rd Edition", McGraw-Hill, Inc., 0-07-100824-1.
- 146 Leendertse. A. (2003). "Fact-sheet on non-thermal plasma treatment of odour", 2003 February 10.
- 147 Lehman N. and Nielsen E.H (2002). "BAT in the Danish herring industry", personal communication.
- 148 Sole (2003). "UHT milk processing - a BAT candidate technology", personal communication.
- 150 Unione Industriali Pastai Italiani (2002). "The efficient use of energy in the Italian pasta industry".
- 151 Austrian contribution (2002). "Production of citric acid", personal communication.
- 152 Austria (2002). "Comments to the 1st draft".
- 154 Ahlers J. et al. (2002). "Precautionary risk assessment and risk management of chemicals, Parts I and II", personal communication.
- 155 UBC Civil Engineering (2003). "Membrane BioReactor", <http://www.civil.ubc.ca/home/civ1525/students00/rachelui/geninfo.html>.
- 157 EC (1999). "Directive 1999/13/EC on the limitation of emissions of volatile organic compounds due to the use of organic solvents in certain activities and installations", European Commission.
- 159 CIAA-CEFS (2003). "Comments on the second draft".
- 160 European Dairy Association (2002). "Consumption and emission data", EDA, personal communication.
- 161 Verband Deutscher Oelmuehlen (2003). "Contribution to Section 3.3.9.4", VDO, personal communication.
- 170 InfoMil (2001). "Netherlands emission guidelines for air (Nederlandse Emissie Richtlijn Lucht- NeR)".
- 179 Gergely, E. (2003). "Production of DDGS (Distiller's Dried Grains with Solubles)", personal communication.
- 181 EC (2003). "Integrated Pollution Prevention and Control, Draft Reference Document on Best Available Techniques in the Slaughterhouses and Animal By-products Industries".
- 182 Germany (2003). "Comments on the second draft".

References

- 183 CIIA-UNAFPA (2003). "Comments on the second draft".
- 184 Italy (2003). "Comments on the second draft".
- 185 CIIA-FEDIOL (2004). "Comments on the second draft".
- 186 CIIA-EUCA (2003). "Comments on the second draft".
- 188 EC (2002). "Regulation (EC) No 1774/2002 of the European Parliament and of the Council of 3 October 2002 laying down health rules concerning animal by-products not intended for human consumption".
- 189 Bockisch M (1993). "Nahrungsfette und - öle".
- 190 Health and Safety Executive (2004). "Information about Legionnaires' Disease".
- 191 EC (1992). "Council Directive 92/46/EEC of 16 June 1992 laying down the health rules for the production and placing on the market of raw milk, heat-treated milk and milk-based products", Official Journal L 268 , 14/09/1992 P. 0001 - 0032.
- 193 Leendertse A. and Haaland A.T (2003). "The performance of the APP odour abatement equipment in relation to operating conditions and measurements".
- 194 EC (1991). "Council Directive 91/676/EEC of 12 December 1991 concerning the protection of waters against pollution caused by nitrates from agricultural sources".
- 195 CEN (2000). "EN 13427 Packaging - requirements for the use of European standards in the field of packaging and packaging waste".
- 196 CEN (2000). "EN 13428 Packaging - requirements specific to manufacturing and composition - prevention by source reduction".
- 197 CEN (2000). "EN 13431 Packaging - requirements for packaging recoverable in the form of energy recovery, including specification of minimum calorific value".
- 198 FPME (2003). "Comments on the second draft".
- 199 Finland (2003). "Comments on the second draft".
- 200 CIIA (2003). "Comments on the second draft".
- 201 EC (1993). "Council Regulation (EEC) No 793/93 of 23 March 1993 on the evaluation and control of the risks of existing substances", Official Journal L 084 , 05/04/1993 P. 0001 - 0075.
- 202 EC (2000). "Regulation (EC) No 2037/2000 of the European Parliament and of the Council of 29 June 2000 on substances that deplete the ozone layer".
- 204 Ireland (2003). "Integrated constructed wetlands".
- 205 DoE SO and WO (1997). "Secretary of State's Guidance - Fish meal and fish oil processes", PG6/19(97).
- 206 EC (1976). "Council Directive 76/464/EEC of 4 May 1976 on pollution caused by certain dangerous substances discharged into the aquatic environment of the Community".

- 207 EC (2000). "Directive 2000/60/EC of the European Parliament and of the Council of 23 October 2000 establishing a framework for Community action in the field of water policy".
- 208 CIAA-AAC-UFE (2003). "Comments on the second draft".
- 209 EC (1991). "Council Directive 91/271/EEC of 21 May 1991 concerning urban wastewater treatment".
- 211 IMPEL (2003). "IMPEL olive oil project".
- 212 The olive oil source (2004). "Disposal of olive oil processing by-products".
- 213 EC (1994). "European Parliament and Council Directive 94/62/EC of 20 December 1994 on packaging and packaging waste", Official Journal L 365 , 31/12/1994 P. 0010 - 0023 Finnish special edition: Chapter 15 Volume 13 P. 0266 Swedish special edition: Chapter 15 Volume 13 P. 0266.
- 215 EC (1996). "Regulation No 136/66/EEC of the Council of 22 September 1966 on the establishment of a common organisation of the market in oils and fats".
- 216 CBMC - The Brewers of Europe (2004). "Potential BATs".
- 217 EC (2003). "Integrated Pollution Prevention and Control Reference Document on Best Available Techniques in Common Waste Water and Waste Gas Treatment/Management Systems in the Chemical Sector".
- 218 EC (1989). "Council Regulation (EEC) No 1576/89 of 29 May 1989 laying down general rules on the definition, description and presentation of spirit drinks".
- 219 EC (2001). "Integrated Pollution Prevention and Control (IPPC) Reference Document on Best Available Techniques in the Cement and Lime Manufacturing Industries".
- 220 EC (2003). "Integrated Pollution Prevention and Control, Draft Reference Document on Best Available Techniques for Large Combustion Plants".
- 221 EC (2000). "2000/479/EC: Commission Decision of 17 July 2000 on the implementation of a European pollutant emission register (EPER) according to Article 15 of Council Directive 96/61/EC concerning integrated pollution prevention and control (IPPC) (notified under document number C(2000) 2004)".
- 222 CIAA-Federalimentare (2003). "Comments on the second draft".
- 223 Italy M. Frey (2003). "Comments on the second draft".
- 224 Portugal-FIPA (2003). "Comments on the second draft".
- 225 Hendley B. (1985). "Market for chilled foods. Food Process 52".
- 226 EC (1998). "Directive 98/8/EC of the European Parliament and of the Council of 16 February 1998 concerning the placing of biocidal products on the market".
- 227 Ockerman H. W. and Hansen C. L. (2000). "Animal by-product processing and utilisation".
- 228 Verband der Deutschen Milchwirtschaft (German Dairy Association) (1997). "EDTA in detergents".

References

- 229 EC (1990). "Council Regulation (EEC) No 3037/90 of 9 October 1990 on the statistical classification of economic activities in the European Community".
- 230 Deutsches Institut für Normung p.v. (2005). "DIN 30600/28004".
- 231 Oxford University Press (2002). "Shorter Oxford English Dictionary".
- 232 Fellows P J "Food processing principles and practice".
- 233 Health and Safety Executive (2000). "Ventilation of kitchens in catering establishments", Catering sheet No 10.
- 234 UK (2003). "Comments on the second draft".
- 235 DG Environment (2003). "Comments on the second draft".
- 236 Ellis L. (2002). "Report on SERET cross-flow filtration of wines".
- 237 Caddet (1999). "The use of Pinch technology in a food processing factory".
- 239 CIAA-EDA (2003). "Comments on the second draft".
- 240 CADDET (1997). "Energy monitoring and target setting at a dairy", UK-1994-522.
- 241 ETSU (2000). "Running refrigeration plant efficiently - a cost effective guide for owners", Good practice guide 279.
- 242 Lewis D. N. (2003). "Noise abatement measures in the food industry".
- 243 EC (2003). "Directive 2003/10/EC of the European Parliament and of the Council of 6 February 2003 on the minimum health and safety requirements regarding the exposure of workers to the risks arising from physical agents (noise)".
- 244 Health and Safety Executive "Top 10 noise control techniques".
- 245 Barale M. (2004). "Reducing milk stone formation".
- 246 EC (2003). "Proposal for a Regulation of the European Parliament and of the Council on certain fluorinated greenhouse gases (COM(2003) 492 final - 0189/2003 COD)", (COM(2003) 492 final - 0189/2003 COD).
- 247 Verband der Deutschen Milchwirtschaft (German Dairy Association) (2003). "Comments on the second draft".
- 250 UK TWG (2004). "Space requirements for membrane bioreactors".
- 251 EC (2005). "COMMISSION REGULATION (EC) No 208/2005 of 4 February 2005 amending Regulation (EC) No 466/2001 as regards polycyclic aromatic hydrocarbons (Text with EEA relevance)".
- 252 Greece (2005). "Information about PAH levels in oils and fats".
- 253 Spain (2005). "Information about two-stage extraction of olive oil".
- 254 Denmark (2005). "Danish contribution to the final plenary TWG meeting".
- 255 Germany (2005). "German contribution to the final plenary TWG meeting".

- 256 European Communities European Chemicals Bureau (2004). "1st Priority List, Volume 49, European Union Risk Assessment Report, Edetic acid (EDTA)".
- 258 Federación Nacional de Asociaciones de la Industria de Conservas Vegetales (2005). "Chemical peach peeling".

GLOSSARY

This glossary is solely intended to assist the reader's understanding of this document. The meanings given may not necessarily reflect legal or dictionary definitions.

Glossary of terms

Activated sludge process	A biological waste water treatment by which bacteria that feed on organic wastes are continuously circulated and put in contact with organic waste in the presence of oxygen to increase the rate of decomposition
Aeration	A biological process by which air is introduced to increase the oxygen concentration in liquids. Aeration may be performed by bubbling air through the liquid, spraying the liquid into the air or agitating the liquid to increase surface absorption. Blowing fresh and dry air through stored crops such as cereal grains, in order to decrease its temperature and/or humidity
Agronomic interests	relating to the science of soil management and crop production
Anaerobic	A biological process which occurs in the absence of oxygen
A/O process	The proprietary A/O process for mainstream phosphorus removal is used for combined carbon oxidation and phosphorus removal from waste water. This process is a single-sludge suspended growth system that combines anaerobic and aerobic sections in sequence
Aquifer	A water-bearing layer of rock (including gravel and sand) that will yield water in usable quantity to a well or spring
Asbestos	A mineral fibre that can pollute air or water and cause cancer or asbestosis when inhaled
Aseptic	Sterile or free of bacterial contamination
Aseptic processing and packaging	Commonly used to describe food processing and packaging techniques for non-refrigerated storage or long-life products, in which packages and food products are sterilised in separate continuous systems. The sterile package is then filled with sterile product, closed and sealed under aseptic conditions
Assimilative capacity	The ability of a natural body of water to receive waste waters or toxic materials without harmful effects and without damage to aquatic life
Bactericide	A substance used to control or destroy bacteria
Baffle	Plate which hinders or regulates the flow of fluid
Bank-filtered water	River water abstracted from outside the river bank
Biochemicals	Chemicals that are either naturally occurring or identical to naturally occurring substances. Examples include hormones, pheromones and enzymes. Biochemicals function as pesticides through non-toxic, non-lethal modes of action, such as disrupting the mating pattern of insects, regulating growth or acting as repellants
Biocoenoses	Association of different organisms forming a closely integrated community. The relationship between such organisms
Biodegradable	That can be broken down physically and/or chemically by micro-organisms. For example, many chemicals, food scraps, cotton, wool and paper are biodegradable
Biodiversity	The number and variety of different organisms in the ecological complexes in which they naturally occur. Organisms are organised at many levels, ranging from complete ecosystems to the biochemical structures that are the molecular basis of heredity. Thus, the term encompasses different ecosystems, species and genes that must be present for a healthy environment. A large number of species must characterise the food chain, representing multiple predator-prey relationships

Biomass	Organic matter available on a renewable basis. Biomass includes forest, agricultural crops and wastes, wood and wood wastes, animal wastes, livestock operation residues, aquatic plants, fast-growing trees and plants, and municipal and industrial wastes
Brix degree (°brix)	Also called % DSSC (% dry soluble substances content). Concentration, expressed as sucrose content, of all substances dissolved in a liquid. X°brix is equivalent to the concentration of all substances dissolved in a juice which causes a refractometric deviation equal to that caused by a solution of X grams of sucrose per 100 grams of solution
Cake	Carbonation slurry after concentration with filter presses to about 70 % DS, e.g. with precipitated calcium carbonate
Catchpot	Fine mesh basket placed over floor drains, to prevent solids from entering the drainage system and the WWTP
Caustic	Sodium hydroxide
Cephalopod	Mollusc of class <i>Cephalopoda</i>
CIP system	Acronym for cleaning-in-place. It is a practice for cleaning tanks, pipelines, processing equipment and process lines by circulating water and cleaning solutions through them without dismantling the pipelines or equipment
Coliform bacteria	Micro-organisms found in the intestinal tracts of humans and animals. Their presence in water indicates fecal pollution and potentially dangerous bacterial contamination by disease-causing micro-organisms
Conching	Conching is a special method of kneading used in the chocolate industry
Condition	Bring to a desired state or condition
Confectionery	Sweets and sweet preparations such as cakes
Cosettes	Thin slices of sugar beet
Crustacean	Member of the Crustacea, a large class of arthropod (animal of phylum Arthropoda, with segmented body and and jointed limbs) with hard shells, mainly aquatic, e.g. crab, lobster, shrimp
Culm	The stem of a plant
Decoction	Concentration of, or extraction of the essence of a substance by boiling
Defrost	The removal of frost from the inside of a refrigerator or coldstore
Degumming	The removal of gums in vegetable oil to avoid colour and taste reversion during subsequent refining steps
Eutrophication	The pollution of a body of water by sewage, fertilisers washed from the land, and industrial wastes (inorganic nitrates and phosphates). These compounds stimulate the growth of algae, reducing the oxygen content in the water, and so killing animals with a high oxygen requirement
Evisceration	Step in the slaughter process by which the contents of the chest and belly cavities of the animals are removed
Fouling	The process of becoming dusty or clogged, e.g. in which undesirable foreign matter accumulates in a bed of filter or ion exchanger media, clogging pores and coating surfaces, thus inhibiting or delaying proper bed operation. The fouling of a heat-exchanger consists of the accumulation of dirt or other materials on the wall of a heat-exchanger, causing corrosion, roughness and ultimately leading to a lowered rate of efficiency
Fresh-pack	Fruit or vegetables which have been packed fresh
Fuller's earth	Soft, greenish-grey rock resembling clay, but without clay's plasticity. It is formed largely of clay minerals, rich in montmorillonite, but a great deal of silica is also present. Its absorbent properties make it suitable for removing oil and grease
Germination	The process whereby seeds or spores sprout and begin to grow, also called sprouting

Gram-negative bacteria	Those bacteria which fail to stain with Gram's reaction. The reaction depends on the complexity of the cell wall and has for long determined a major division between bacterial species
Herbicide	Any chemical toxic substance, usually used to kill specific unwanted plants, especially weeds
HEPA filter	High efficiency particulate air filter
Hull	Outer covering of fruit and seeds, especially pod of peas and beans, husk of grain, or green calyx of strawberry
Ice-water	Cooled water which is then used for cooling
Immission	Pollutant mass/concentration that is dissipated to the environment. It is measured where the environmental impact occurs.
Kieselguhr	A light soil consisting of siliceous remains of microscopic one-celled or colonial algae, used for filtering purposes, also called diatomeaceous earth
Lecithin	Any of a group of natural phospholipids which are esters of a phosphatidic acid with choline; such phospholipids collectively; a mixture containing these, used commercially as a food emulsifier etc.
Lees	The sediment of wine or some other liquids
Lyophilisation (freeze-drying)	The process of preserving food products by freezing them and then evaporating the water (in the form of ice) by sublimation
Malt sprouts	The shoots which grow during germination of malt
Marc	The residue, e.g. skins, pits and seeds, remaining after the juice has been pressed from a fruit, usually apple or grapes
Mash	Malt mixed with hot water to form wort
Miscella	Mixture of crude vegetable oil and hexane formed during solvent extraction of vegetable oils
Mitzithra cheese	Cheese made from whey
Mollusc	Soft-bodied and usually hard-shelled animal belonging to the phylum <i>Mollusca</i>
Must	Any juice or liquid prepared undergoing alcoholic fermentation, e.g. grape juice or the pulp of apples or pears
Native starch	Refined starch without any chemical and/or physical modification
Nibs	Pieces of peeled fermented cacao beans
Oenology	Of or pertaining to the knowledge of making wines
Ostwald combustion diagram	The Ostwald combustion diagram shows in graphical form the theoretical relationships among the products of combustion of hydrocarbons. The interdependence of CO ₂ , O ₂ , CO, and air-fuel ratio is given. By this, it is possible to determine the CO and air-fuel ratio when the values for CO ₂ and O ₂ are known
Pasteurisation	Thermal process, treatment, or combination thereof, that is applied to food to reduce the most resistant micro-organisms of public health significance to a level that is not likely to present a public health risk under normal conditions of distribution and storage. Thermal pasteurisation treatments are time/temperature equivalent combinations to obtain a certain decimal (log) reduction of viable organisms with a reduced detrimental effect on flavour and chemistry of the food
Perry	A juice like cider, made from pears
Pesticide	Biological, physical or chemical agent used to kill pests. In practice, the term pesticide is often applied only to chemical agents. Various pesticides are known as insecticides, nematocides, fungicides, herbicides and rodenticides, i.e., agents primarily effective against insects, nematodes (or roundworms), fungi, weeds and rodents, respectively
PhoStrip process	In the proprietary PhoStrip process for side-stream phosphorus removal, a portion of the return activated sludge process is diverted to an anaerobic phosphorus stripping tank

Pomace	The residue, e.g. skins, pits and seeds, remaining after the juice has been pressed from, e.g. apples, pears and olives
Pome	A fleshy fruit with a central seed-bearing core, e.g. apple
Primary packaging	Packaging conceived so as to constitute a sales unit to the final user or consumer at the point of purchase
Re values (Reynolds number)	The Reynolds number is the ratio of inertial forces, as described by Newton's second law of motion, to viscous forces. If the Reynolds number is high, inertial forces dominate, resulting on a turbulent flow. If it is low, viscous forces prevail, resulting on a laminar flow
Rootlet	A small root, e.g. on grain during malting
Sankey diagram	Diagrams used for displaying flows through a system, e.g. to show mass and energy flows
Secondary packaging	packaging conceived so as to constitute at the point of purchase a grouping of a certain number of sales units whether the latter is sold as such to the final user or consumer or whether it serves only as a means to replenish the shelves at the point of sale; it can be removed from the product without affecting its characteristics
Sparge	To sprinkle, e.g. water, aerate a liquid with air or inject steam. In brewing, a spray of hot water sprinkled over the malt
Stabulation	Storing wine at low temperature
Standardised milk	Milk which has been treated to adjust the fat content to a specified percentage which depends on the milk's intended use
Soil tare	The weight of soil, gravel and stones carried with crops when they are harvested
Sump	A pit, well or hole used for collecting water or other fluid
Surimi	Minced, processed fish used in the preparation of an imitation of seafood, especially shellfish
Tempering	A process used in chocolate processing that ensures product quality and appearance; enable handling of liquid chocolate for various applications; ensure viscosity control; and enable net weight requirements to be met. Tempering is also the controlled thawing of meats
Tertiary packaging	Packaging conceived so as to facilitate handling and transport of a number of sales units or grouped packagings in order to prevent damage due to physical handling and transport
Thaw	To unfreeze food
Thermal resistance (K/W or °C/W)	The thermal resistance of an insulating material, in thermal ohms, is the R-value (a commercial unit used to measure the effectiveness of thermal insulation) divided by the thickness of the material, in meters
Trub	A coarse coagulum of proteinaceous precipitated material which is separated from the wort as part of the brewing process
Vanillin	A sweet smelling crystalline aldehyde which is the chief essential constituent of vanilla
Van der waals forces	Forces that exist between molecules of the same substance. These forces are much weaker than chemical bonds, and random thermal motion around room temperature can usually overcome or disrupt them. The forces operate only when molecules pass very close to each other, during collisions or near misses
Vinasses	A by-product that is generated when processing molasses. After the fermentable sugar in molasses has been used by the micro-organisms (e.g. yeasts) and the compounds produced have been separated out (e.g. alcohol is distilled), this is the remaining nutrient medium. The non-sugar substances that have not been assimilated and metabolic side products are in this liquid. Vinasses may be concentrated to give a solids content of 70 % by multiple-effect evaporators
Viscera	The organs contained within the trunk, considered collectively, e.g. the digestive tract, heart and lungs

Wort	A sweet infusion of ground malt or other grain before fermentation, used to produce, e.g. beer and distilled malt liquors
------	---

Abbreviations

ADMS	Atmospheric dispersion modelling system
AOCI	Adsorbable organic chlorine compounds
AOX	Adsorbable organic halogen compounds. The total concentration in milligrams per litre, expressed as chlorine, of all halogen compounds (except fluorine) present in a sample of water that are capable of being adsorbed on activated carbon
ATMP	Amino trimethyleme phosphonic acid
a_w	Water activity The water activity (a_w) of a given food is defined as $a_w = p_f/p_w,$ where p_f and p_w are the pressures of water vapour in equilibrium with the given food system and with pure water, respectively, both at the same temperature
BAFF	Biological aerated flooded filter
BAT	Best Available Technique(s)
BOD	Biochemical oxygen demand: the quantity of dissolved oxygen required by micro-organisms in order to decompose organic matter. The unit of measurement is mg O ₂ /l. In Europe, BOD is usually measured after 3 (BOD ₃), 5 (BOD ₅) or 7 (BOD ₇) days
BREF	BAT reference document
BSE	Bovine spongiform encephalopathy
C ₁ , C ₂ etc	Organic compounds indicated by the number of carbon atoms
CaO	Calcium oxide
Ca(OH) ₂	Calcium hydroxide
CCl ₄	Carbon tetrachloride
CEN	The European Committee for Standardisation
CEFS	Comité Européen des Fabricants de Sucre
CFC	Chlorofluorohydrocarbons
CFM	Cross flow microfiltration
CFU	Colony-forming unit
CGS	Co-generation system (for power generation)
CH ₄	Methane
CHCl ₃	Trichloromethane (chloroform)
CHP	Co-generation of heat and power (combined heat and power)
CIAA	Confederation of the food and drink industries of the EU
CIP	Cleaning-in-place
Cl ₂	Chlorine
CMF	Cross-flow microfilter
CO	Carbon monoxide
CO ₂	Carbon dioxide
COD	Chemical oxygen demand: the amount of potassium dichromate, expressed as oxygen, required to chemically oxidise at approximately 150 °C substances contained in waste water
COP	Coefficient of performance
DAF	Dissolved air flotation
DC	Dry condensing
DDGS	Distiller's dried grains with solubles
DMRI	Danish Meat Research Institute
DT	Desolventiser-toaster
DTPMP	Diethylenetriamine pentakis methylenephosphonic acid
ED	Electrodialysis

EDTA	Ethylenediaminetetraacetic acid
e.g.	For example (Latin: <i>exempli gratia</i>)
EGSB	Expanded granular sludge blanket (reactor)
EIPPCB	European IPPC Bureau
EMAS	Eco-Management and Audit Scheme
EMS	Environmental management system
EP	Electrostatic precipitator
EPA	US Environment Protection Agency
ESP	Electrostatic precipitator
ETBPP	Environmental Technology Best Practice Programme (UK)
EC	European Commission
EU	European Union
EU-15	A, B, D, DK, E, EL, F, FIN, I, IRL, L, NL, P, S and UK
EU-25	A, B, CY, CZ, D, DK, E, EE, EL, F, FIN, HU, I, IRL, L, LV, LT, MT, NL, P, PL, S, SI, SK and UK
EUCA	European Coffee Association
FBD	Fluidised bed drier
FDM	Food, drink and milk
FFS	Form, fill and seal
Fe	Iron
FeCl ₃	Iron trichloride
ffa	Free fatty acids
F/M ratio	Food to micro-organism ratio
FOG	Fats, oils and greases
GE	A standard odour unit (OU) defined as the quantity of odour carrier in 1 m ³ neutral air that causes a smell perception
GMO	Genetically modified organisms
HACCP	Hazard Analysis Critical Control Points
HCFC	Hydrochlorofluorocarbon
HCH	Hexachlorocyclohexane (lindane). An insecticide
HCl	Hydrochloric acid
HDPE	High density poly-ethylene
HEPA	High efficiency particulate air
HFC	Hydrofluorocarbons
HHST	High heat short time (pasteurisation)
HP	High pressure
HPLV	High pressure low volume
H ₂ SO ₄	Sulphuric acid
HTD	High temperature drying
HTST	High temperature short time (pasteurisation)
IC	Internal circulation (waste water treatment reactor)
ICW	Integrated constructed wetlands
IDS	Iminodisuccinat
IMPEL	European Union Network for the Implementation and Enforcement of Environmental Law
ISCST	Industrial source complex short term (model)
ISO	International Organisation for Standardisation
IPPC	Integrated pollution prevention and control
LAS	Linear alkylated benzenesulphonacids
LDPE	Low density poly-ethylene
LOEC	Lowest observed effect concentration. The lowest experimentally determined concentration of a test substance at which adverse effects can be observed
LP	Low pressure
LPG	Liquified petroleum gas
LTD	Low temperature drying

LTDM	Long-term frequency distribution model
MAP	Modified atmosphere packing
MBR	Membrane bio-reactor
MF	Microfiltration
MGDA	Methylglycin diacetate
MLSS	Mixed liquor suspended solids
Mo	Molybdenum
MS(s)	Member state(s) of the European Union
MVR	Mechanical vapour recompression
MWWTP	Municipal waste water treatment plant
n.d.	No data
n.e.c	Not elsewhere classified
NF	Nanofiltration
NGO	Non-governmental organisation
NH ₃	Ammonia
NH ₄	Ammonium
NH ₄ -N	Ammonium nitrogen
NPV	Net present value
N-tot	Total nitrogen
NTA	Nitrilotriacetate
NTU	Nephelometric turbidity units
OU	Odour unit(s) (see also GE)
P	Phosphorus
PAH	Polyaromatic hydrocarbons
PE	Polyethylene
PET	Polyethylene terephthalate
Pid	Process and instrumentation diagrams
PLC	Programmable logic control
PM	Particulate matter
PP	Polypropylene
PS	Polystyrene
PTA	Peseta
PTFE	Polytetrafluorethylene
PVC	Polyvinyl chloride
QAC	Quaternary ammonium compounds
RBC	Rotating biological contactors
RO	Reverse osmosis
RPM	Rotations per minute
RTD	Research, technology and development
SBAF	Submerged biological aerated filter
SBR	Sequencing batch reactor
SEC	Specific energy consumption
SME	Small and medium enterprise(s)
SO _x	Sulphur oxides
SO ₂	Sulphur dioxide
SO ₃	Sulphur trioxide
SS	Suspended solids
TDS	Total dissolved solids
TKN	Total Kjeldahl nitrogen
TOC	Total organic carbon
TS	Total solids
TSE	Transmissible spongiform encephalopathy
TSS	Total suspended solids
TVR	Thermal vapour recompression
TWG	Technical working group

UASB	Upflow anaerobic sludge blanket (reactor)
UF	Ultrafiltration
UHP	Ultra-high pressure
UHT	Ultra-high temperature (sterilisation)
UV	Ultraviolet
VOC(s)	Volatile organic compound(s) (not limited to the definition of volatile organic compound in Council Directive 1999/13/EC)
WFE	Wiped film evaporator
WHB	Waste heat boiler
WHO	World Health Organisation
WWTP	Waste water treatment plant
XPP	Expanded polypropylene

Member States list

Short Name	Full Name	Abbreviation
Austria	Republic of Austria	A
Belgium	Kingdom of Belgium	B
Cyprus	Republic of Cyprus	CY
Czech Republic	Czech Republic	CZ
Germany	Federal Republic of Germany	D
Denmark	Kingdom of Denmark	DK
Spain	Kingdom of Spain	E
Estonia	Republic of Estonia	EE
Greece	Hellenic Republic	EL
France	French Republic	F
Finland	Republic of Finland	FIN
Hungary	Republic of Hungary	HU
Italy	Italian Republic	I
Ireland	Ireland	IRL
Luxembourg	Grand Duchy of Luxembourg	L
Latvia	Republic of Latvia	LV
Lithuania	Republic of Lithuania	LT
Malta	Republic of Malta	MT
Netherlands	Kingdom of the Netherlands	NL
Portugal	Portuguese Republic	P
Poland	Republic of Poland	PL
Sweden	Kingdom of Sweden	S
Slovakia	Slovak Republic	SK
Slovenia	Republic of Slovenia	SI
United Kingdom	United Kingdom of Great Britain and Northern Ireland	UK

Currency abbreviations

Abbreviation	Currency
ATS	Austrian schilling
BEF	Belgian franc
CZK	Czech koruna
DEM	German mark
DKK	Danish krone
EEK	Estonian kroon
ESP	Spanish peseta
EUR	Euro
FIM	Finish markka
FRF	French franc
GBP	Pound sterling
GRD	Greek drachma
HUF	Hungarian forint
IEP	Irish pound
ITL	Italian lira
NLG	Dutch guilder
PLN	Polish zloty
PTE	Portuguese escudo
SEK	Swedish krona

Common units, measurements and symbols

TERM	MEANING
ACkWh	kilowatt-hours (alternating current)
atm	normal atmosphere (1 atm = 101325 N/m ²)
bar	bar (1.013 bar = 1 atm)
barg	bar gauge (bar + 1 atm)
billion	thousand million (10 ⁹)
°C	degree Celsius
cgs	centimetre gram second. A system of measurements now largely replaced by SI.
cm	centimetre
cSt	centistokes = 10 ⁻² stokes
d	day
°C/W	thermal resistance
dB	Decibel. The unit of measuring noise levels
dB(A)	Noise is measured in decibels (dB). To address the way the human ear responds to sound of different frequencies (pitches), an A-weighting is commonly applied, and the measurements are expressed in dB(A). Every 3 dB(A) reduction is equivalent to halving the noise level.
eV	electron volt
g	gram
GE	
GJ	gigajoule
Hz	hertz
h	hour
ha	hectare (10 ⁴ m ²) (=2.47105 acres)
hl	hectolitre
hPa	hectopascal (1hPa = 100 Pa)
J	joule
K	kelvin (0 °C = 273.15 K)
kA	kiloamp(ere)
kcal	kilocalorie (1 kcal = 4.19 kJ)

TERM	MEANING
kg	kilogramme (1 kg = 1000 g)
kJ	kilojoule (1 kJ = 0.24 kcal)
kPa	kilopascal
kt	kilotonne
kW	kilowatt
kW _e	kilowatt in the form of electrical energy
kWh	kilowatt-hour (1 kWh = 3600 kJ = 3.6 MJ = 0.0036 GJ)
kWh _e	kilowatt-hour in the form of electrical energy
l	litre
m	metre
m ²	square metre
m ³	cubic metre
m ² .°C/W	thermal resistance unit
mg	milligram (1 mg = 10 ⁻³ gram)
MJ	megajoule (1 MJ = 1000 kJ = 10 ⁶ joule)
nm	nanometre (1nm = 10 ⁻⁹ m)
mm	millimetre (1 mm = 10 ⁻³ m)
m/min	metres per minute
mmWG	millimetre water gauge
Mt	megatonne (1 Mt = 10 ⁶ tonne)
Mt/yr	megatonnes per year
mV	millivolts
MW _e	megawatts electric (energy)
MW _{th}	megawatts thermal (energy)
ng	nanogram (1 ng = 10 ⁻⁹ gram)
Nm ³	normal cubic metre (101.325 kPa, 273 K)
Pa	pascal
ppb	parts per billion
ppm	parts per million (by weight)
ppmv	parts per million (by volume)
s	second
sq ft	square foot (= 0.092 m ²)
St	stokes. An old, cgs unit of kinematic viscosity 1 St = 10 ⁻⁶ m ² /s
S unit (S/m or mS/cm)	electrical conductivity (Siemens per metre or milliSiemens per centimetre)
TJ	terajoule (1TJ = 10 ⁶ MJ = 10 ⁹ kJ= 10 ¹² joule)
t	metric tonne (1000 kg or 10 ⁶ gram)
t/d	tonnes per day
trillion	million million (10 ¹²)
t/yr	tonne(s) per year
V	volt
vol-%	percentage by volume (also % v/v)
% v/v	percentage by volume (also vol-%)
W	watt (1 W = 1 J/s)
wt-%	percentage by weight (also % w/w)
% w/w	percentage by weight (also wt-%)
yr	Year
ΔT	increase of temperature
~	around; more or less
μm	micrometre (1 μm = 10 ⁻⁶ m)
Ω	ohm, unit of electrical resistance
Ω cm	ohm centimetre, unit of specific resistance